

KAR-YAPI

TASARIM KAR. İNŞ. İML. TURZ. TAŞ. SAN. TİC. A.Ş.

“Yapının Sanatı”
'Art of Construction'

kar-sis®
iç ve dış dekor ürünleri

kar-pol®
izolasyon & ambalaj

kar-miks®
yapı kimyasalları

kar-shop®
online satış



Ürün Kataloğu
Product Catalogue

KAR-YAPI

TASARIM KAR. İNŞ. İML. TURZ. TAŞ. SAN. TİC. A.Ş.

Dünyanın neresinde olursanız olun, **sizler için üretiyoruz...**

Wherever you are in the world, **we produce for you ...**



“Yapının Sanatı”

'Art of Construction'



ÜRETİM ALANI: 66,500 m²

Production Area: 66. 500 m²

ÇALIŞAN SAYISI: 300

Number of Employees: 300

ÜRÜN ÇEŞİDİ: 875

Product Types: 875

DİSTRİBÜTÖR SAYISI: 22

Number of Distributors: 22

SATIŞ NOKTASI: 740

Number of Sales Points: 740

İHRACAT ÜLKE SAYISI: 38

Number of Export Countries: 38

EPS ÜRETİM KAPASİTESİ: 15,000 ton/yıl

Eps Production Capacity: 15. 000 tons/year

XPS İŞLEME KAPASİTESİ: 50,000 m³/yıl

Xps Processing Capacity: 50. 000 m³/year

YAPI KİMYASALLARI ÜRETİM KAPASİTESİ: 72,000 ton/yıl

Production Capacity of Construction Chemicals: 72. 000 tons/year

Yaşamınızda **yep yeni** bir sayfa açın...

Open a new page in your life...



İÇ VE DIŞ DEKOR ÜRÜNLERİ
interior and exterior decoration
products



İZOLASYON VE AMBALAJ ÜRÜNLERİ
insulation and packaging products



YAPI KİMYASALLARI
construction chemicals



AMBALAJLI DEKOR ÜRÜNLERİ
packaged decoration products

içindekiler Index

kar-sis® içeridekor ürünleri		
KARTONPİYER MODELLERİ	08-09	moulding models
GİZLİ IŞIKLI KARTONPİYER MODELLERİ	10-11	led hidden moulding models
EPS KLAS KARTONPİYER MODELLERİ	12-13	eps class models
BORDÜR MODELLERİ	14	bordure model
ÇITA MODELLERİ	15	slat models
DEKORATİF TAVAN KAPLAMALARI (Ekonomik)	16-17	decorative ceiling plates (economic)
DEKORATİF TAVAN KAPLAMALARI (Standart)	18	decorative ceiling plates (standard)
ASMA TAVAN PLAKALARI	19	suspended ceiling plates
DESENLİ LAMBA GÖBEKLERİ	20	figured lamp centers
LAMBA GÖBEKLERİ	21	ceiling lamp centers
AHŞAP TONOZ MODELLERİ	22	wooden vaults models
AHŞAP PROFİL MODELLERİ	23	wooden profile models
İÇ DEKOR UYGULAMA TEKNİKLERİ	24-25	interior decoration application techniques
CEPHE KAPLAMALARI	26-27	exterior siding
BİTİŞ PROFİLLERİ	29	finishing profiles
DIŞ CEPHE DEKOR PROFİLLERİ	30-31	facade decoration profiles
DIŞ DEKOR PROFİLLERİ	32-33	exterior decoration profiles
DAMLALIKLI DIŞ CEPHE DEKOR PROFİLLERİ	35	exterior facade decoration profiles with dripstone
DESENLİ DIŞ CEPHE DEKOR PROFİLLERİ	37	figured exterior facade decoration profiles
PENCERE DEKOR ÜRÜNLERİ	38-41	window decoration products
DIŞ CEPHE MOTİFLERİ	42-43	exterior facade motives
PAYANDALAR	45	buttress
SÜTUN VE KAİDELER	46-47	columns and pedestals
KABARTMA SÜTUN VE KAİDELER	48-49	embossed columns and pedestals
DIŞ DEKOR UYGULAMA TEKNİKLERİ	50-51	exterior decoration application techniques

kar-pol® isolepani & ambalaj		
KAR-PANEL	54	polystyrene panel
KAR-NEOPANEL	55	carbonaceous panel
KAR-BOARD	56	polystyrene board
KAR-YERIS	57	floor heating system
THERMO-KAR PALTOLAMA SİSTEMLERİ	58	thermo-kar jacketing systems
KAR-MOLEN / KAR-MOLEN KLAS	59	polistren asmolen / polystyrene hollow block polistren asmolen / polystyrene hollow block klas
KAR-BLOK	60	polystyrene block
KAR-VİYOL	61	polystyrene seed trays
KAR-KASA	62-63	polystyrene vegetable-fruit crates
TAŞIMA KAPLARI	64-65	carrying case
KAR-MER	66	polystyrene marble case
ÖZEL ÜRÜN ÜRETİMLERİ	67	production of special products

kar-shop® online satış		
REGOLA KARTONPİYER MODELLERİ	70	regola moulding models
REGOLA AMBALAJLI ÜRÜNLER	71	regola packaged products
REGOLA AHŞAP MODELLER	72	regola wooden models
MARKET İÇİ RAF DÜZENEĞİ	73	regola market stand equipment

kar-miks® yapı kimyasalları		
YAPI KİMYASALLARI	74-75	construction chemicals
POLİSTREN YAPIŞTIRICISI		polystyrene adhesive
POLİSTREN ELYAFLI SIVA		polystyrene fiber plaster
ADERANS ARTTIRICI		adherence increaser
EK YERİ HARCİ		joint mortar

KAR-YAPI® TASARIM KAR, İNŞ. İM. TURİZ. TAŞ. SAN. TİC. A.Ş.		
KALİTE POLİTİKAMIZ	76-77	quality policy
KALİTE BELGELERİMİZ	78-79	quality certifications



İÇ VE DIŞ DEKOR ÜRÜNLERİ

Interior And Exterior Decoration Products





Kar-sis, polistren iç ve dış dekor ürünleri üretmek amacıyla, 2001 yılında Antalya Organize Sanayi Bölgesinde kurulmuştur. 66.500m² kapalı alanda EPS ve XPS polistren kütük ve plakalardan CNC tezgâhlarda farklı ihtiyaçlara göre şekillendirilerek üretilen ürünler, yapıları zenginleştiren tüm detayları ön plana çıkartmaktadır. Kar-sis markalı ürünler, çağdaş, ekonomik, esnek, hafif ve kolay montaj edilebilmesi ile büyük avantajlar sağlamaktadır. Kar-sis, sahip olduğu geniş ürün yelpazesinin yanı sıra kişisel istek ve tarza göre çözümler üreterek müşterilerine sınırsız alternatifler sunar.



Kar-sis has been established with purpose of manufacturing polystyrene interior and exterior decoration products in Antalya Organized Industry Area in 2001. All products, which are produced from EPS and XPS polystyrene blocks and plates shaped on CNC workbenches according to different needs and 66.500m²sqm indoor area, feature all details that enrich structures. Kar-sis brand products provide great advantage with its modern, economical, flexible, light and easy-to-install properties. Apart from its wide products range, Kar-Sis provides unlimited alternatives by producing solutions according to personal requests and styles.

KARTONPİYER MODELLERİ

Moulding Models

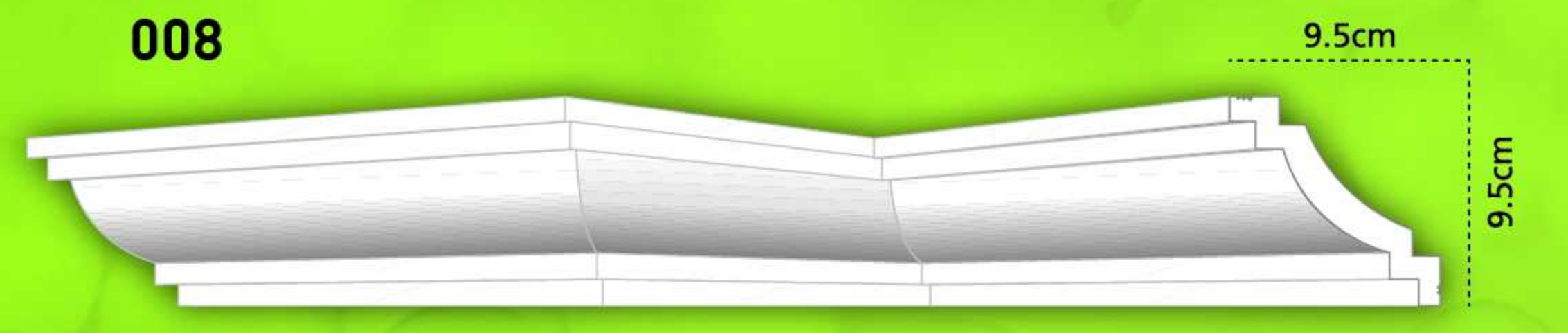
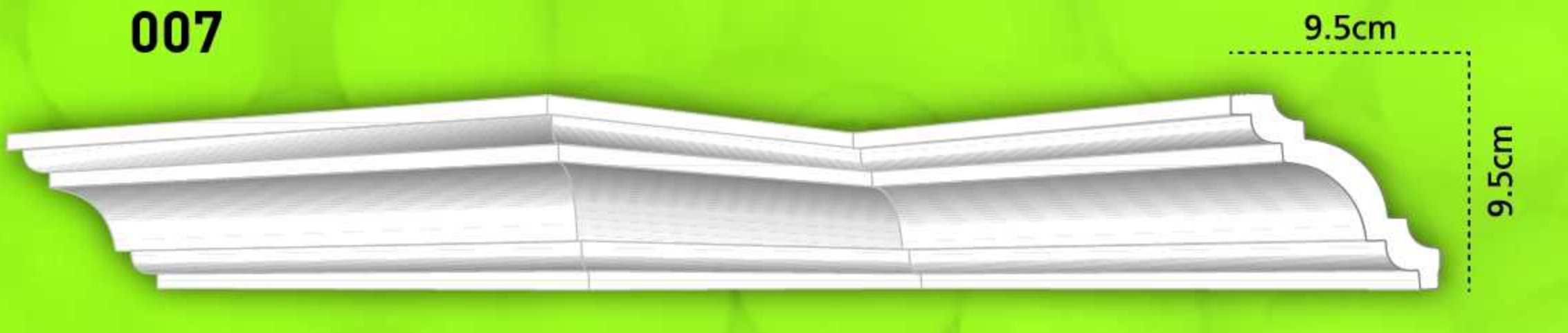
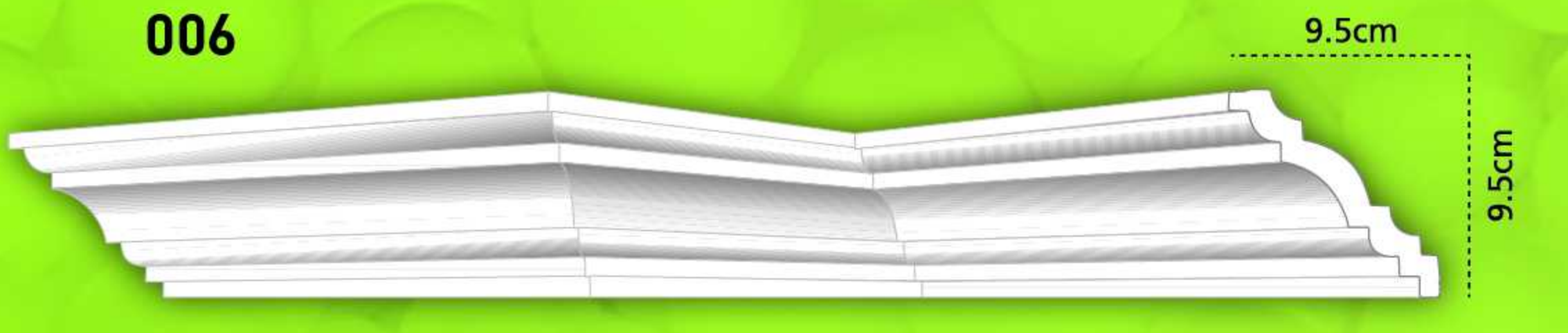
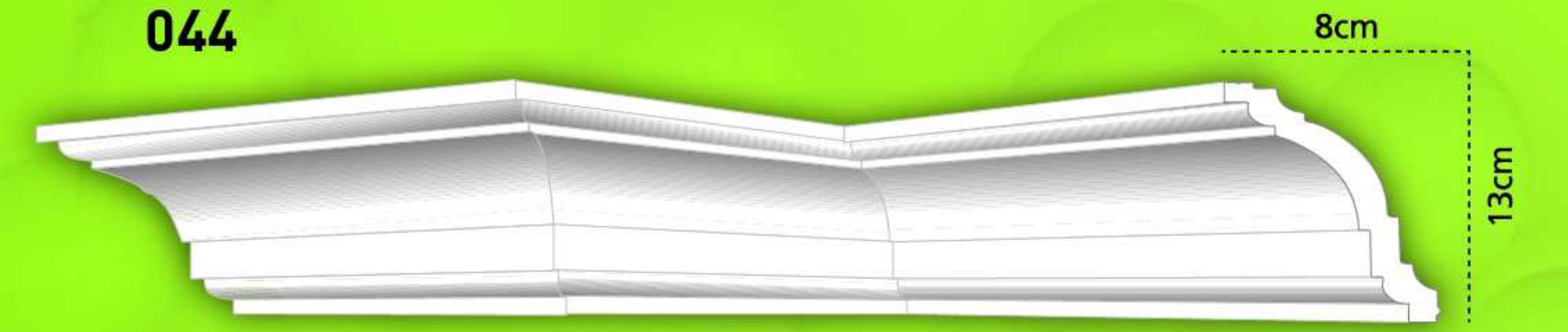
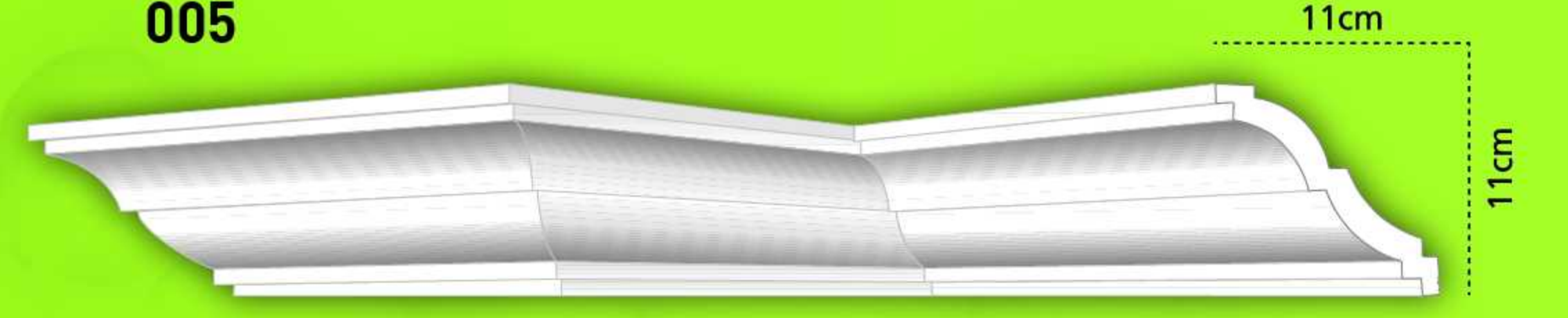
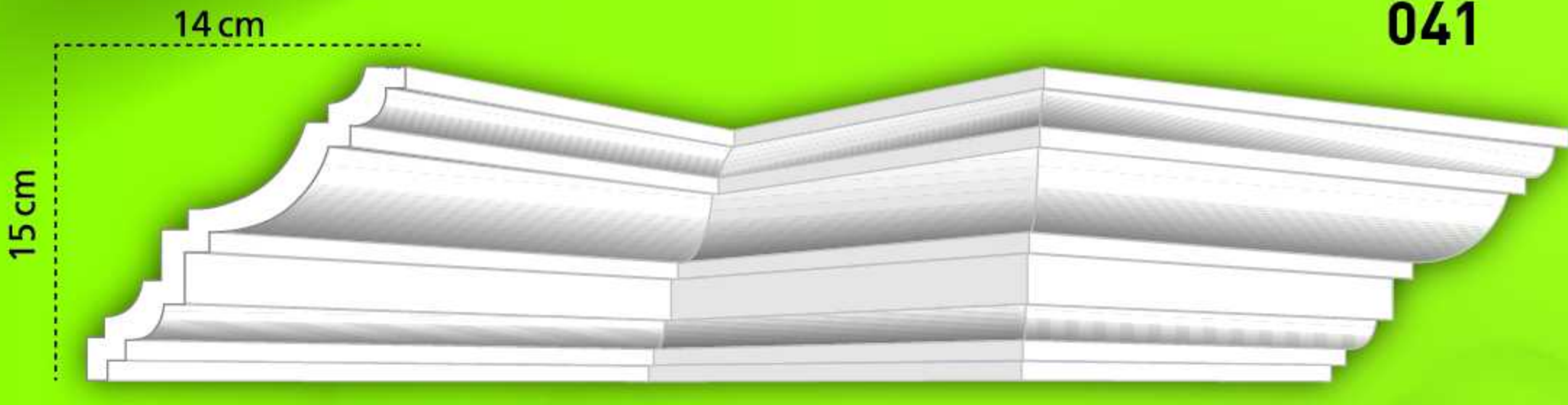

- Ürünlerimizin uygulaması HKS yapıştırıcılarımızla yapılmalıdır.
- Application of our products must be done with HKS adhesive.

Standart boylar 200 cm 'dir - The standard length is 200 cm

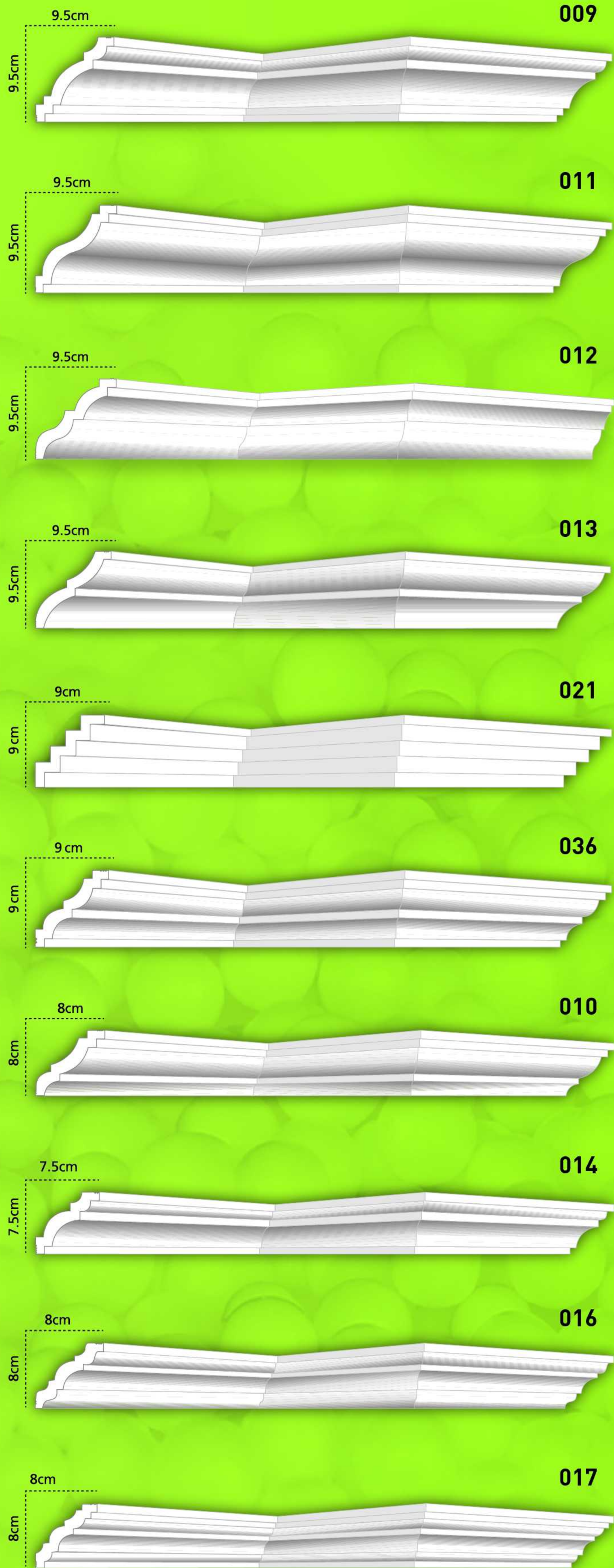

**PERDELİK
TAKVİYELERİ**
curtain supports

perdelik montaj kesiti
curtain support cross-section

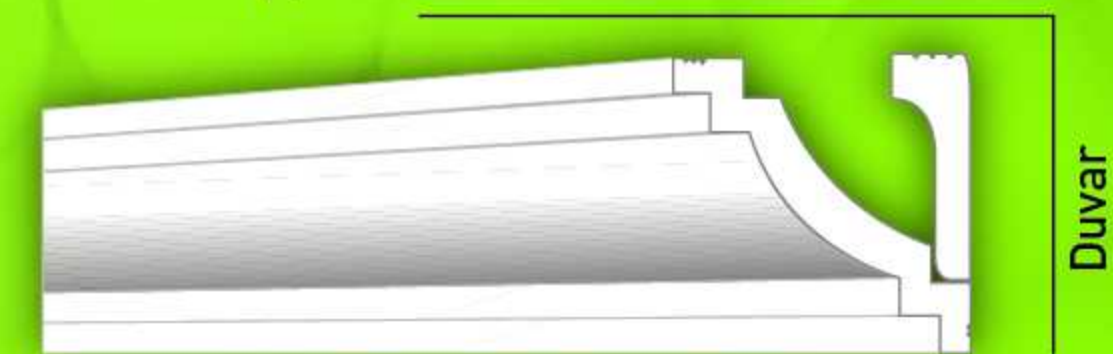

per 12cm'ye göre for 12cm curtain support



per 10cm'ye göre for 10cm curtain support

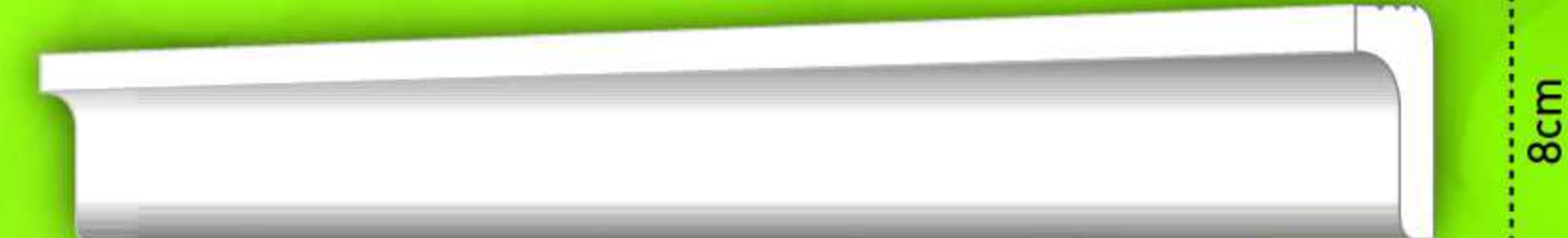

per 7cm'ye göre for 7cm curtain support



- Ürünlerimizin uygulaması HKS yapıştırıcılarımızla yapılmalıdır.
- Application of our products must be done with HKS adhesive.

Standart boylar 200 cm 'dir - The standard length is 200 cm

GİZLİ IŞIKLI KARTONPİYER MODELLERİ

Led Hidden Moulding Models



LED / 001



LED / 002



LED / 003



- Ürünlerimizin uygulaması HKS yapıştırıcılarımızla yapılmalıdır.
- Application of our products must be done with HKS adhesive.

Standart boylar 200 cm 'dir - The standard length is 200 cm

“hayatı güzelleştiren detaylar”

‘details beautify the life’

LED / 004



LED / 005

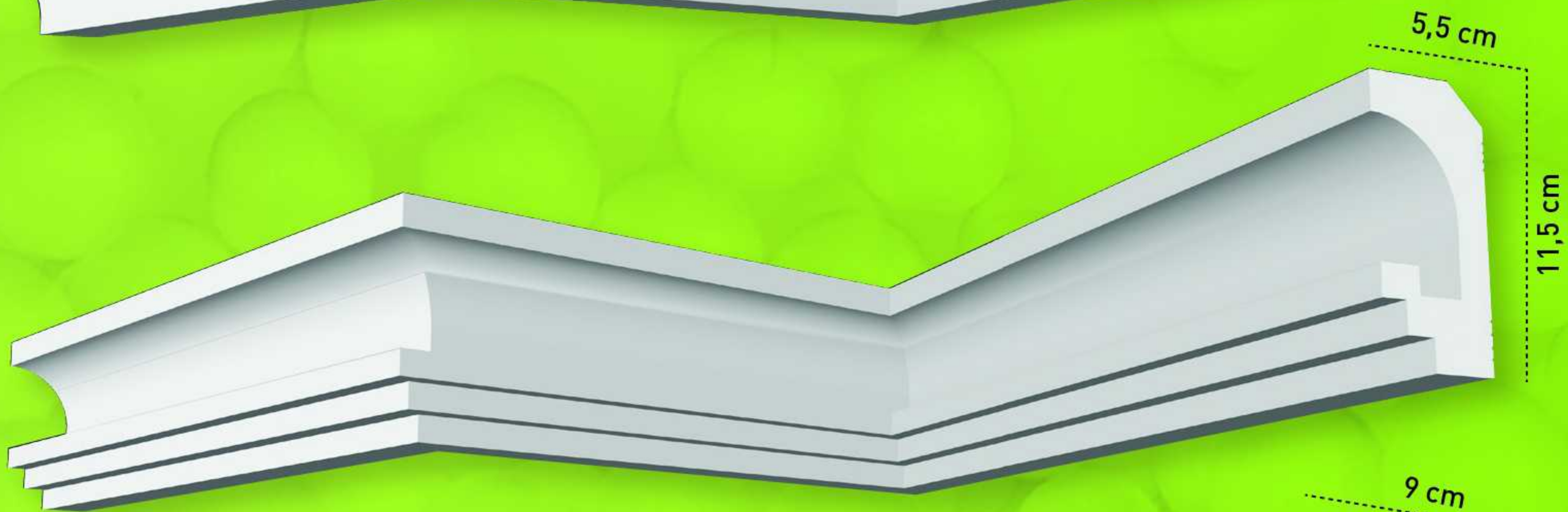

LED / 006

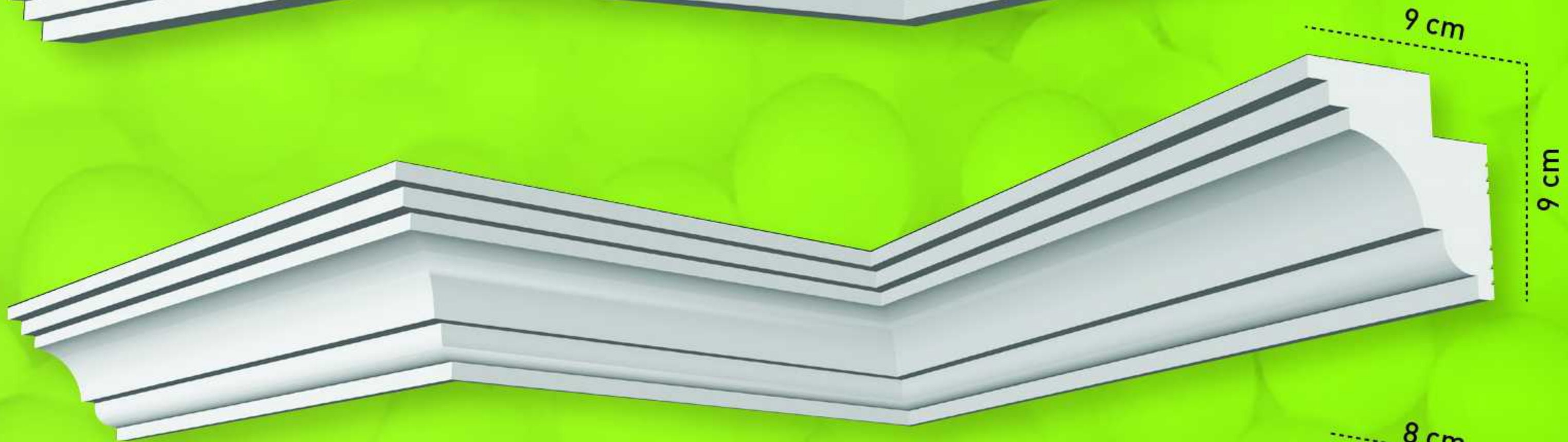

LED / 007

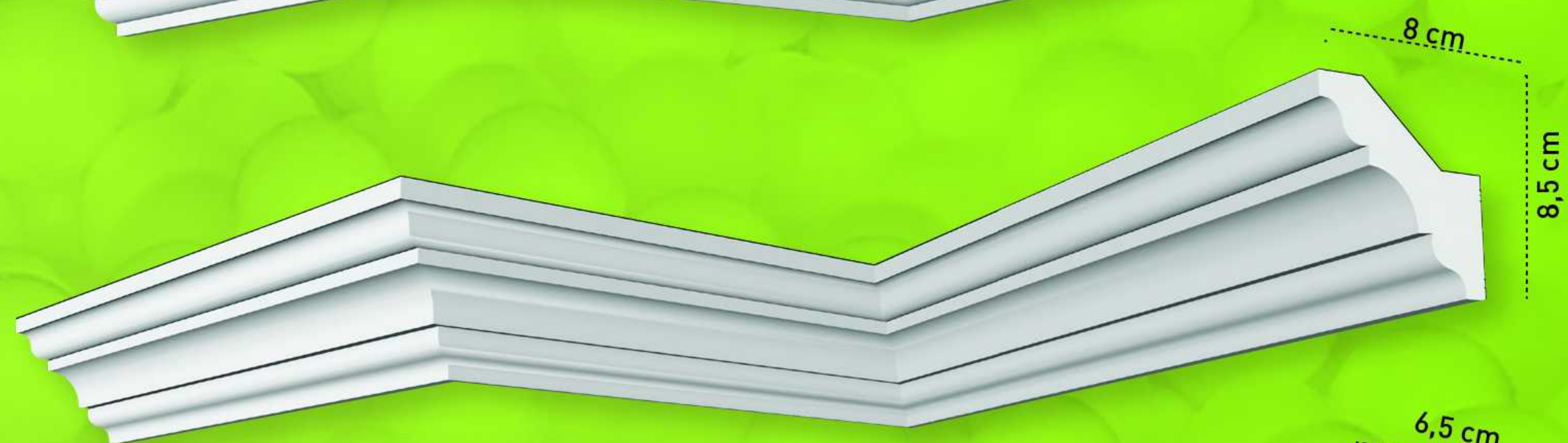

LED / 008

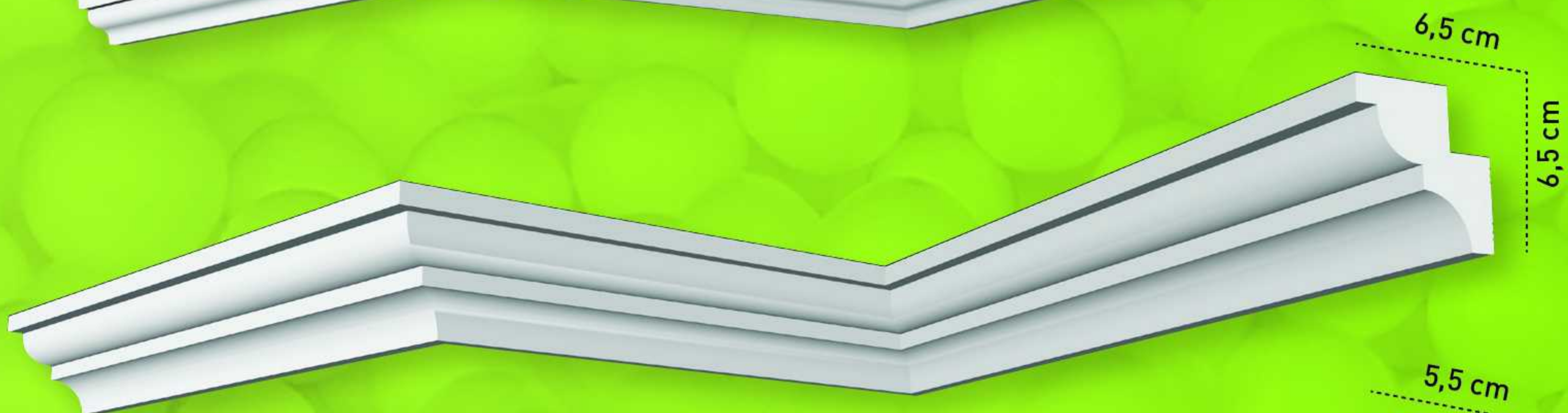

LED / 009

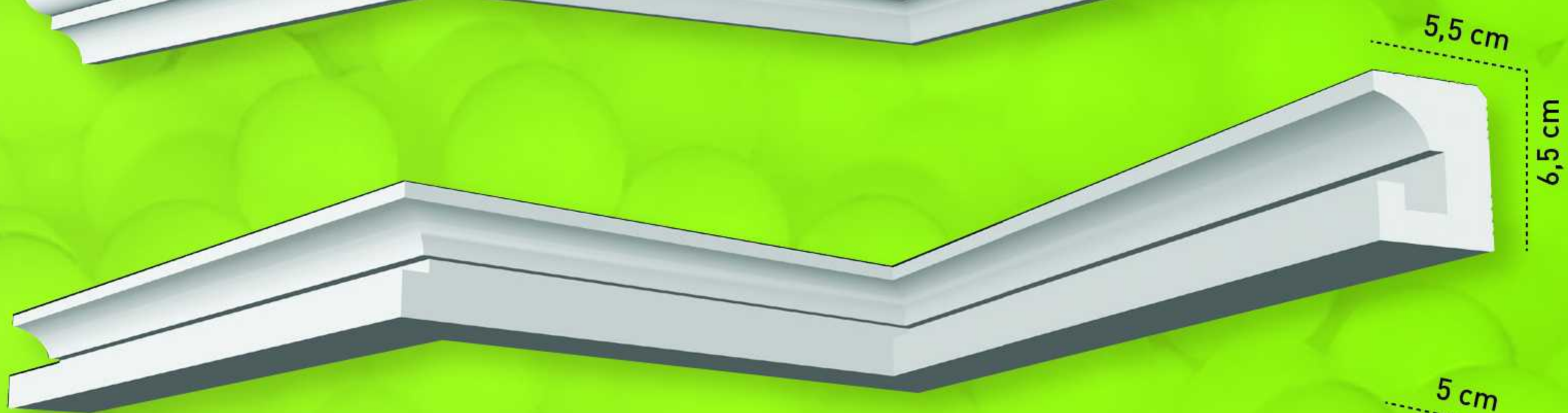

LED / 010

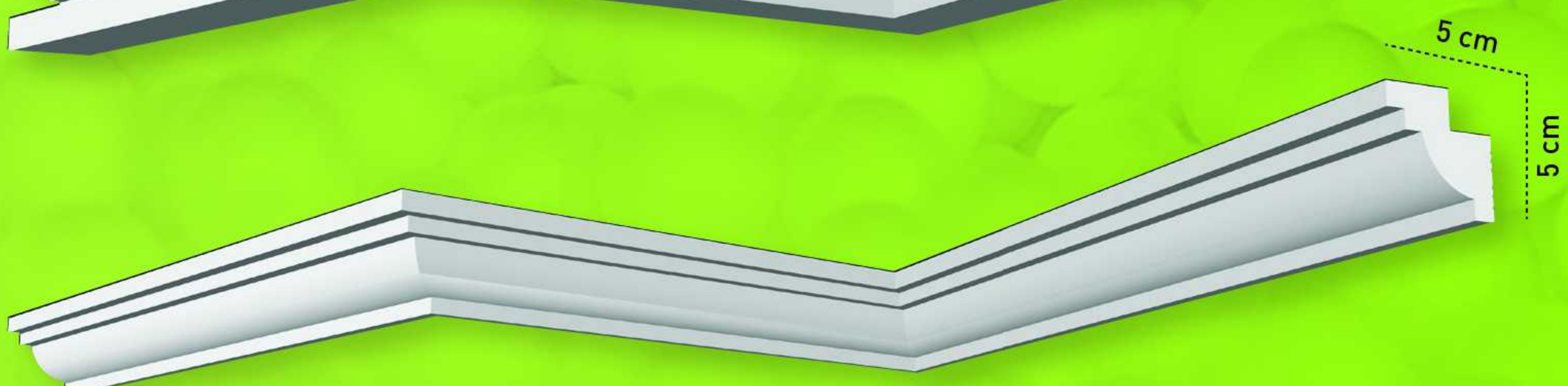

- Ürünlerimizin uygulaması HKS yapıştırıcılarımızla yapılmalıdır.
- Application of our products must be done with HKS adhesive.

Standart boylar 200 cm 'dir - The standard length is 200 cm

EPS KLAS KARTONPİYER MODELLERİ

Eps Klas Models



EPS KLAS 201

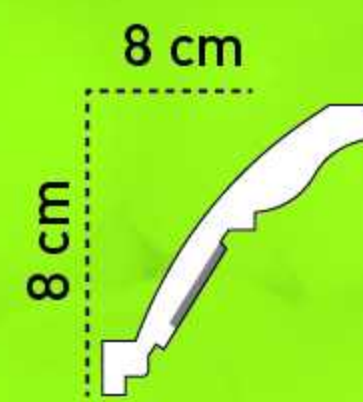

EPS KLAS 202

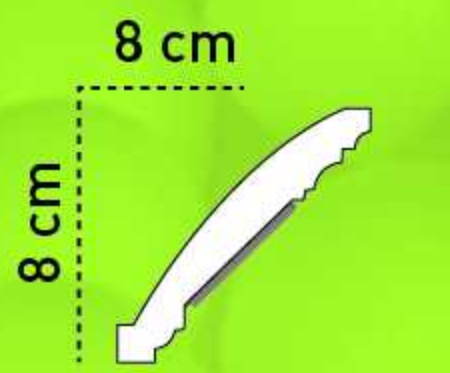

EPS KLAS 203

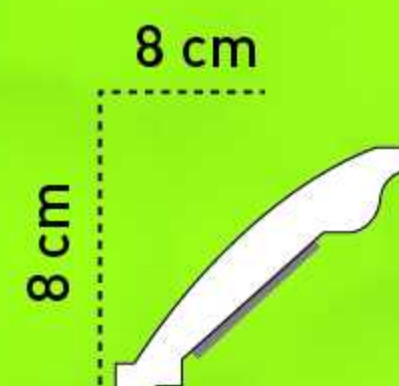

EPS KLAS 204

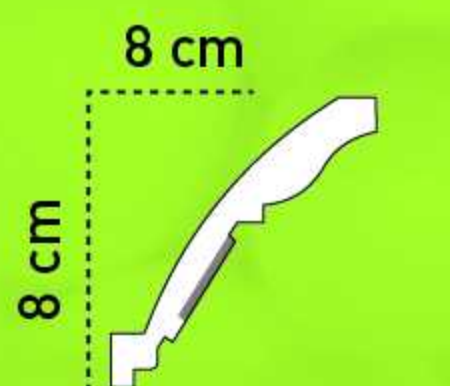

- Ürünlerimizin uygulaması HKS yapıştırıcılarımızla yapılmalıdır.
- Application of our products must be done with HKS adhesives.

Standart boylar 200 cm 'dir - The standard length is 200 cm



EPS KLAS 151

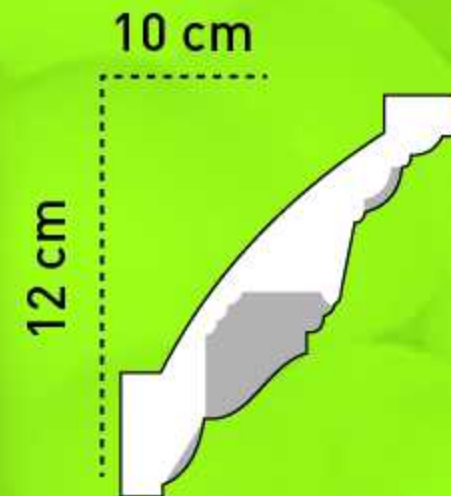
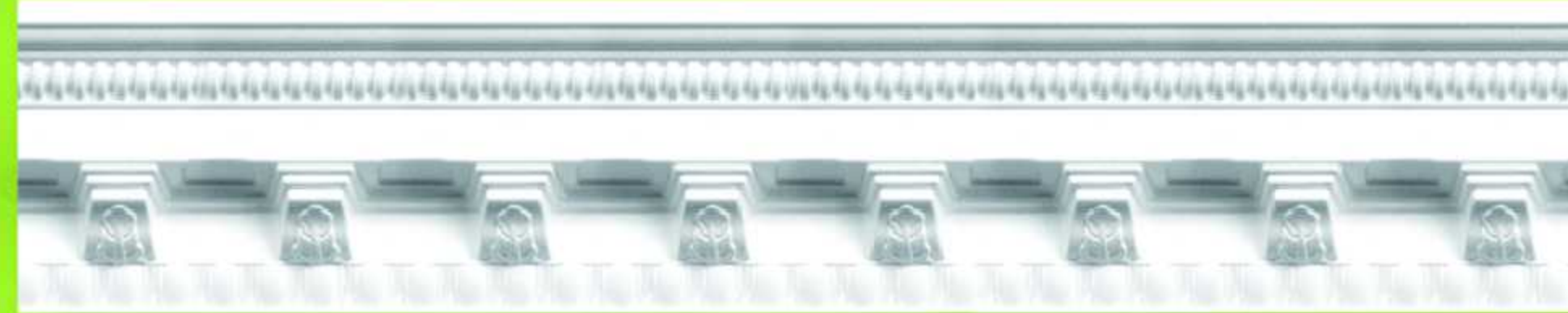

EPS KLAS 152



EPS KLAS 153



EPS KLAS 154

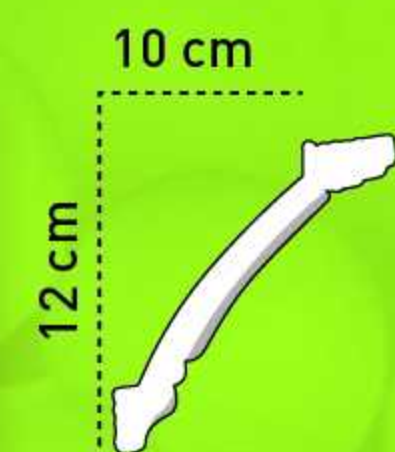

EPS KLAS 155

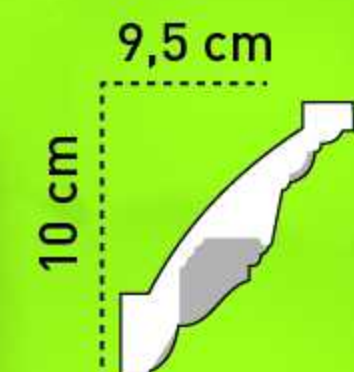

EPS KLAS 156

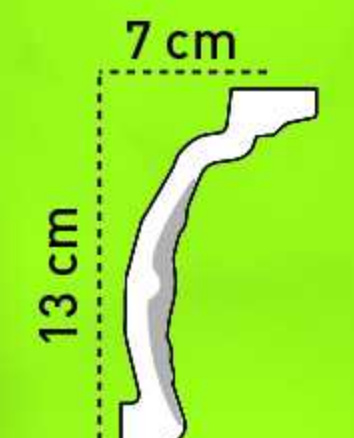

EPS KLAS 101



EPS KLAS 102



EPS KLAS 103

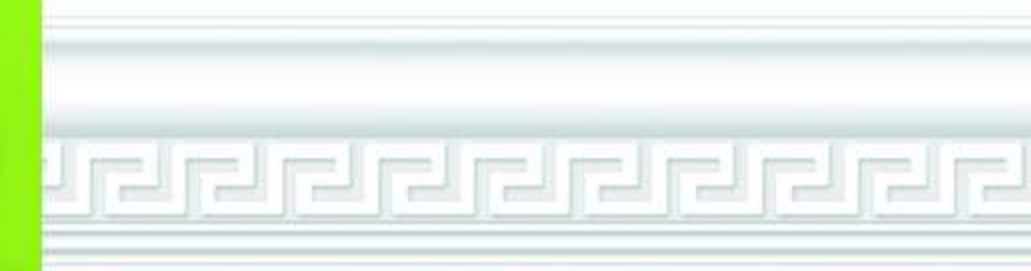

EPS KLAS 104

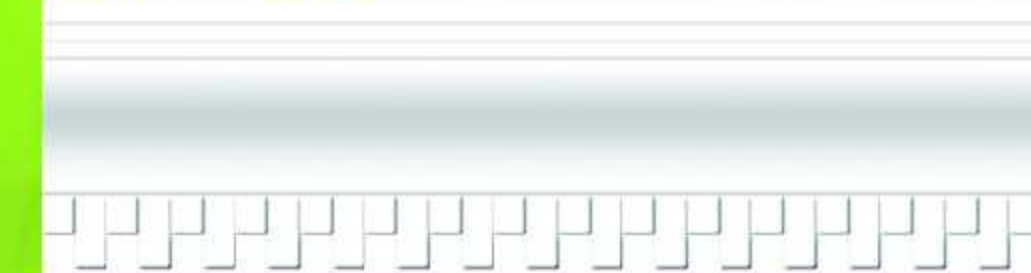

EPS KLAS 105

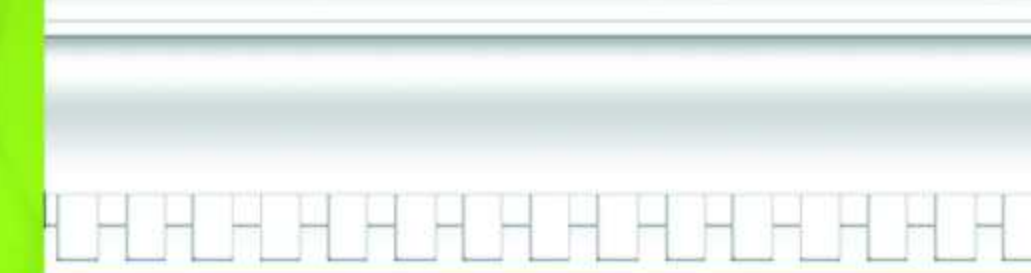

EPS KLAS 106

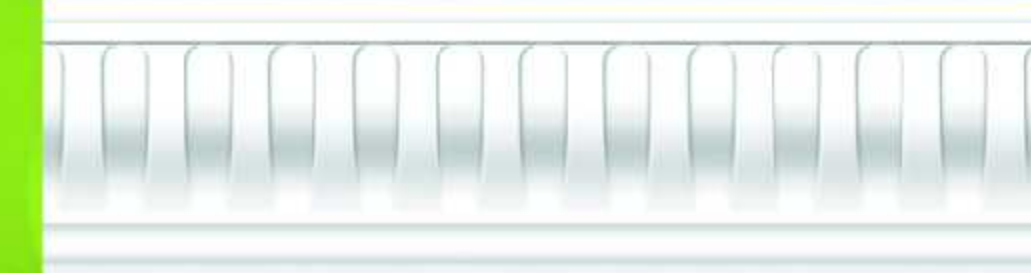

EPS KLAS 107

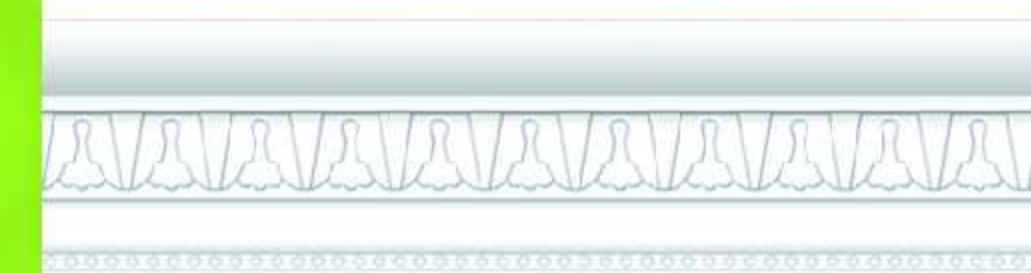

EPS KLAS 108



EPS KLAS 109

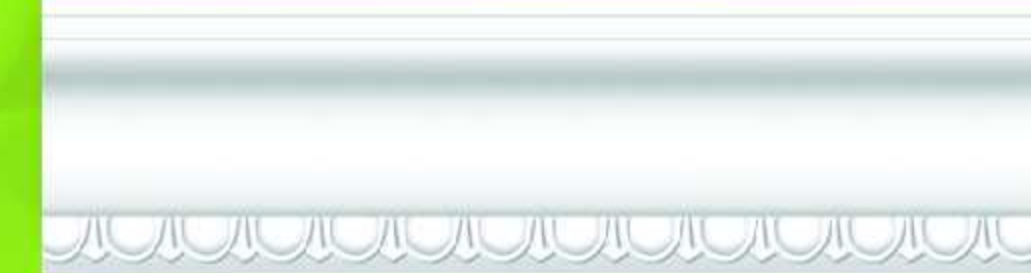

EPS KLAS 110



EPS KLAS 111

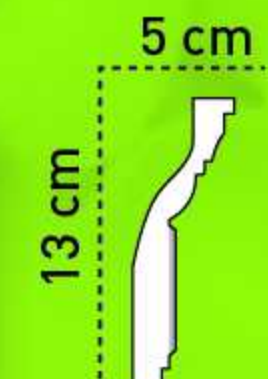

EPS KLAS 112



EPS KLAS 113



EPS KLAS 114



- Ürünlerimizin uygulaması HKS yapıştırıcılarımızla yapılmalıdır.
- Application of our products must be done with HKS adhesive.

Standart boylar 200 cm 'dir - The standard length is 200 cm

BORDÜR MODELLERİ

Bordure Models

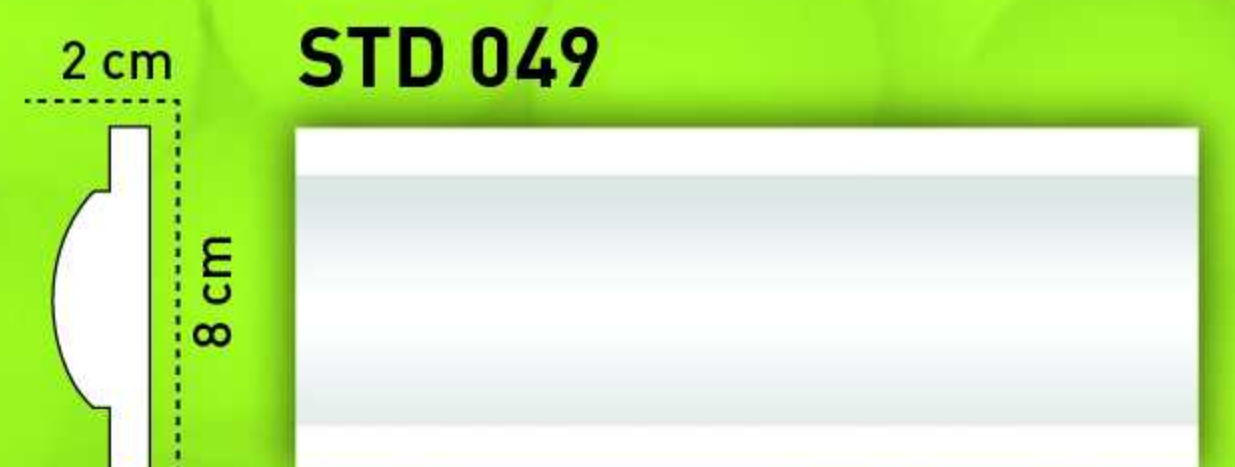

ÇITA MODELLERİ

Slat Models

ÇM 01
25cm x 13cm

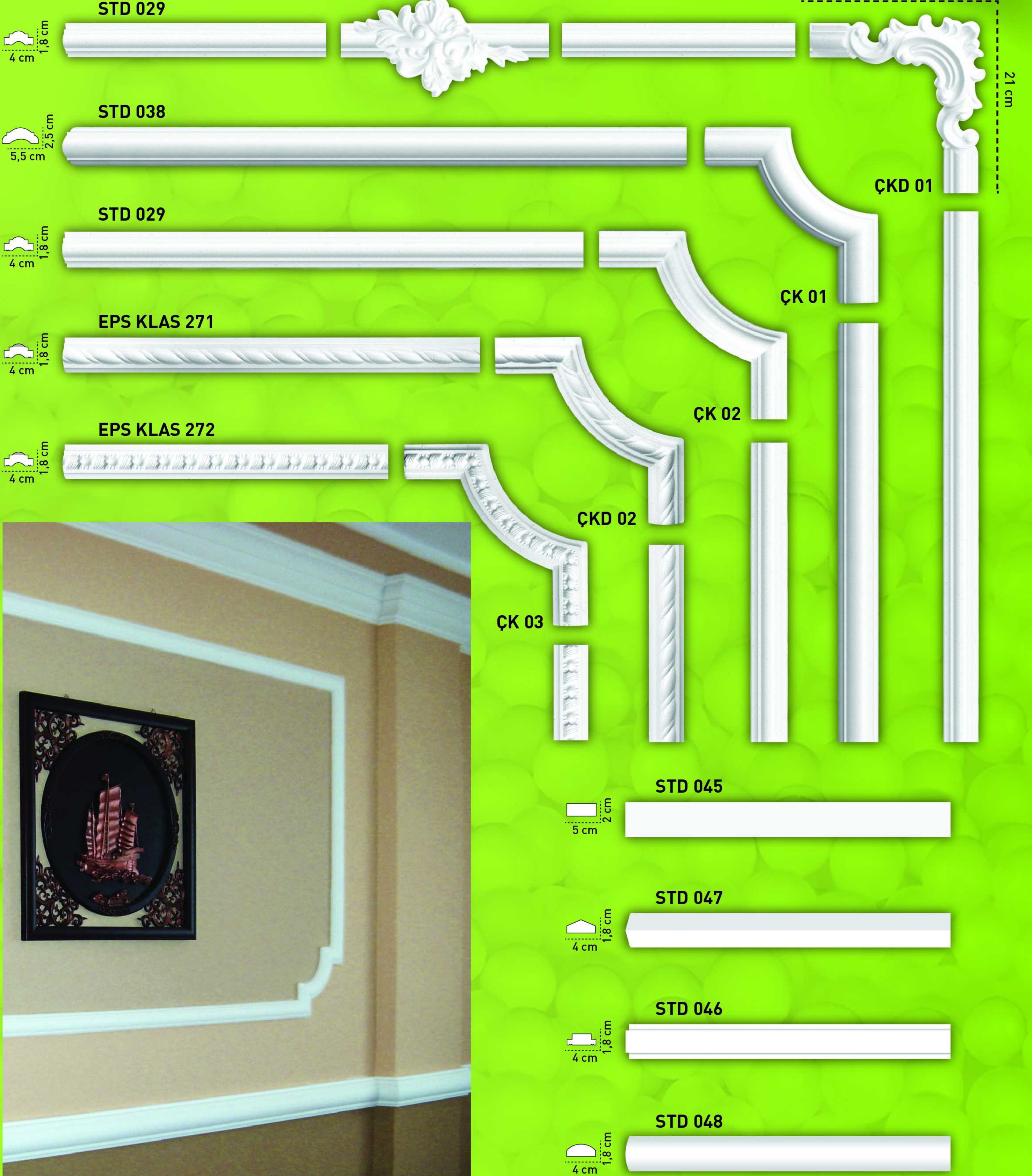

- Ürünlerimizin uygulaması HKS yapıştırıcılarımızla yapılmalıdır.
- Application of our products must be done with HKS adhesives.

Standart boylar 200 cm 'dir - The standard length is 200 cm

DEKORATİF TAVAN KAPLAMALARI (EKONOMİK)

Decorative Ceiling Plates (Economic)



Dekoratif tavan kaplama plakaları 8 mm kalınlığında EPS polistren olup, pres baskı ile şekillendirilmektedir. Montajı kolay olup, istenirse üzeri su bazlı boya ile boyanabilmektedir. Dekoratif yönüne ek olarak izolasyon da sağlamaktadır.

The decorative ceiling plates are EPS polystyrene with 8mm thickness and shaped moulded by press compression. It may be painted any colour by using water based paint. Addition to its decorative aspect, it also provides insulation.

EFES 5001
50 cm x 50 cm



BERGAMA 5002
50 cm x 50 cm



SELÇUK 5003
50 cm x 50 cm



ULUDAĞ 5004
50 cm x 50 cm

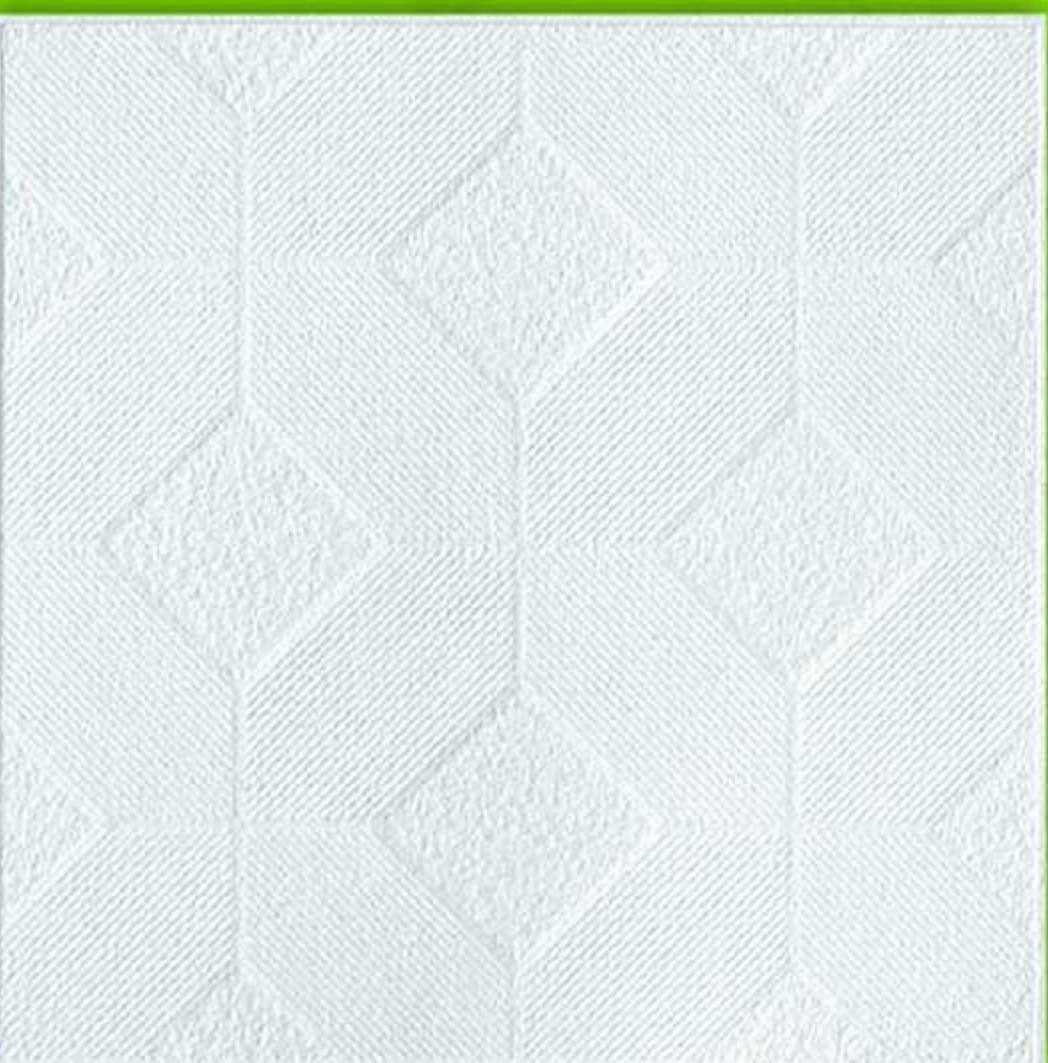

KAPADOKYA 5005
50 cm x 50 cm



GÖREME 5006
50 cm x 50 cm



“hayatı güzelleştiren detaylar”

‘details beautify the life’



PAMUKKALE 5007

50 cm x 50 cm

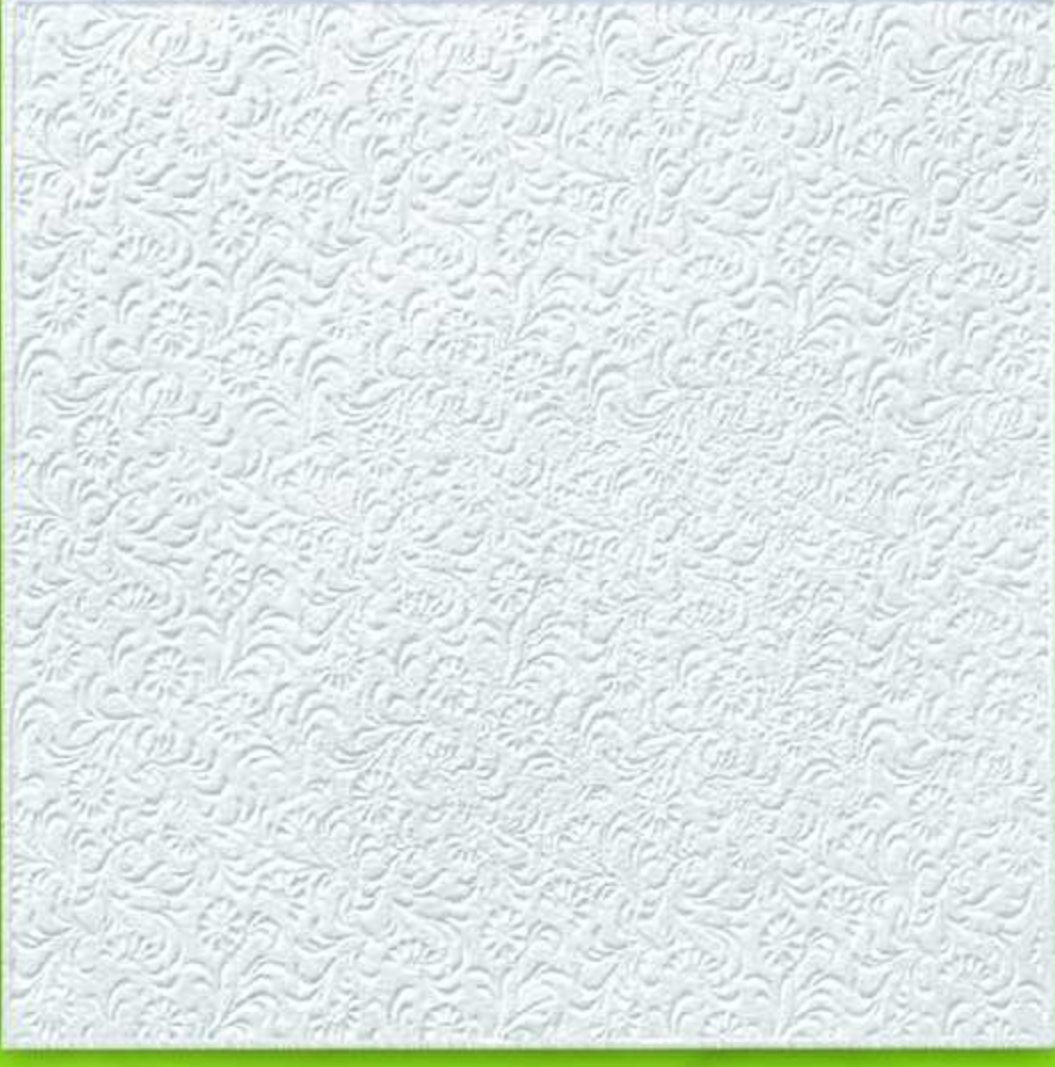

DALAMAN 5008

50 cm x 50 cm



HEREKE 5009

50 cm x 50 cm



MERİNOS 5010

50 cm x 50 cm



MAÇKA 5011

50 cm x 50 cm



ÜRGÜP 5012

50 cm x 50 cm

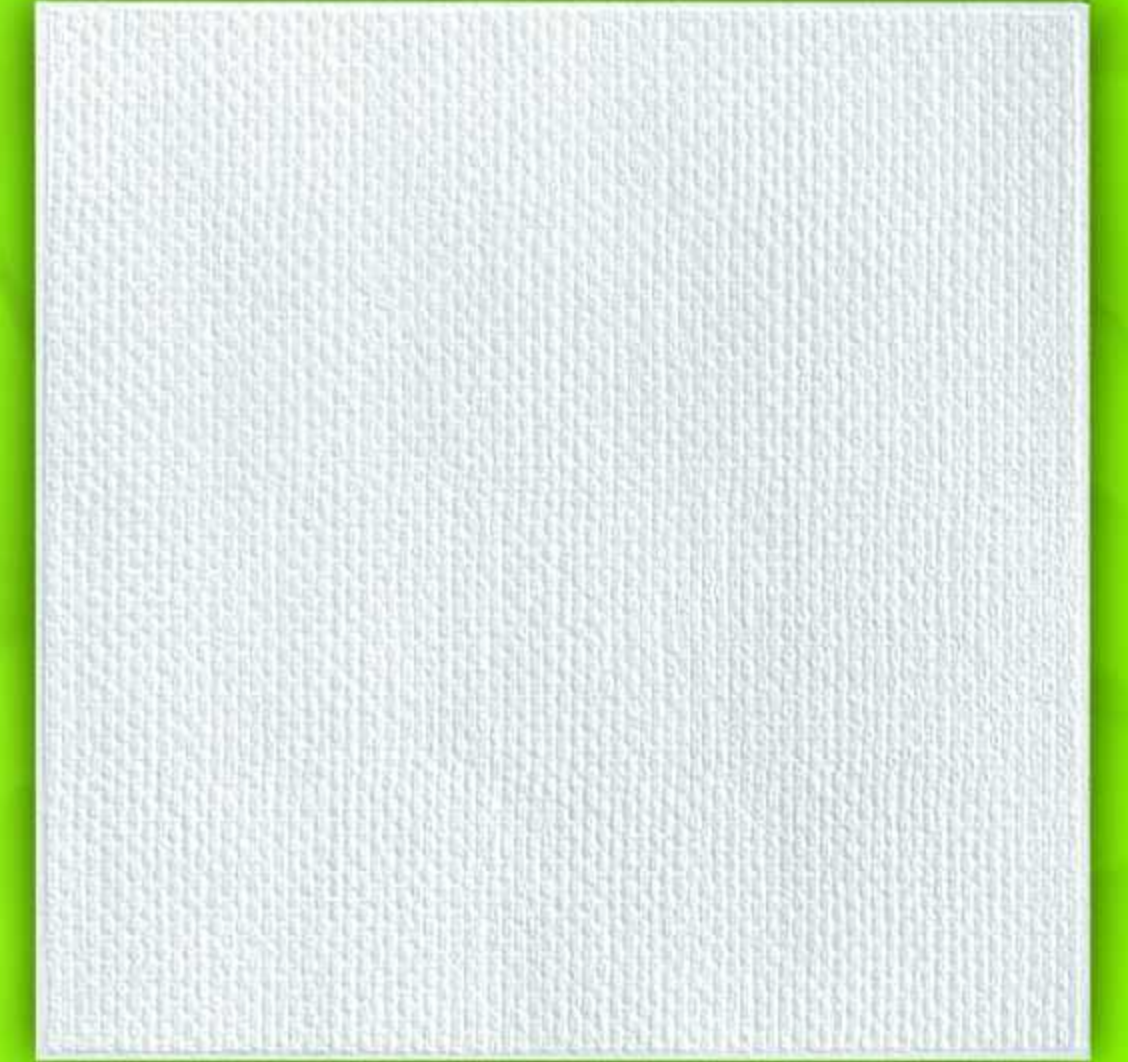

ABANT 5013

50 cm x 50 cm



TERKOS 5014

50 cm x 50 cm



KAÇKAR 5015

50 cm x 50 cm

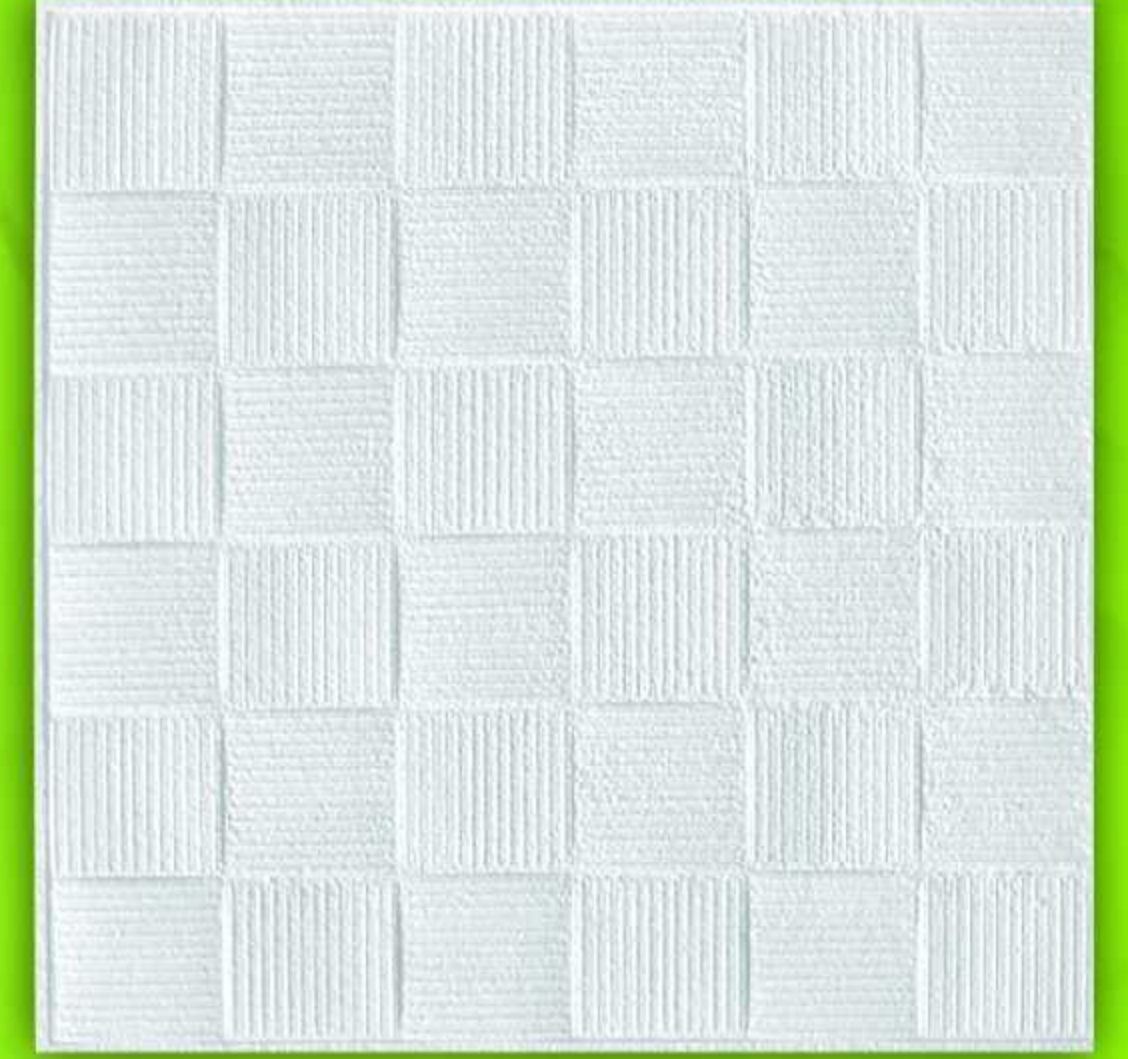

• Ürünlerimizin uygulaması HKS yapıştırıcılarımızla yapılmalıdır. / • Application of our products must be done with HKS adhesive

DEKORATİF TAVAN KAPLAMALARI (STANDART)

Decorative Ceiling Plates (Standard)

Dekoratif tavan kaplama plakaları standart kalınlığında EPS polistren olup, enjeksiyon makinalarında kalıplı üretim yapılmaktadır. Montajı kolay olup, istenirse üzeri su bazlı boya ile boyanabilmektedir. Dekoratif yönüne ek olarak izolasyon da sağlamaktadır.

Decorative ceiling plates are EPS polystyrene with standard thickness and produced in the injection machines with molds. It is easy to montage and could be painted with water based paint. In addition to its decorative aspect, it also provides insulation.

SAKLIKENT 1111
50,2 cm x 50,2 cm



KARAIN 1112
50,2 cm x 50,2 cm

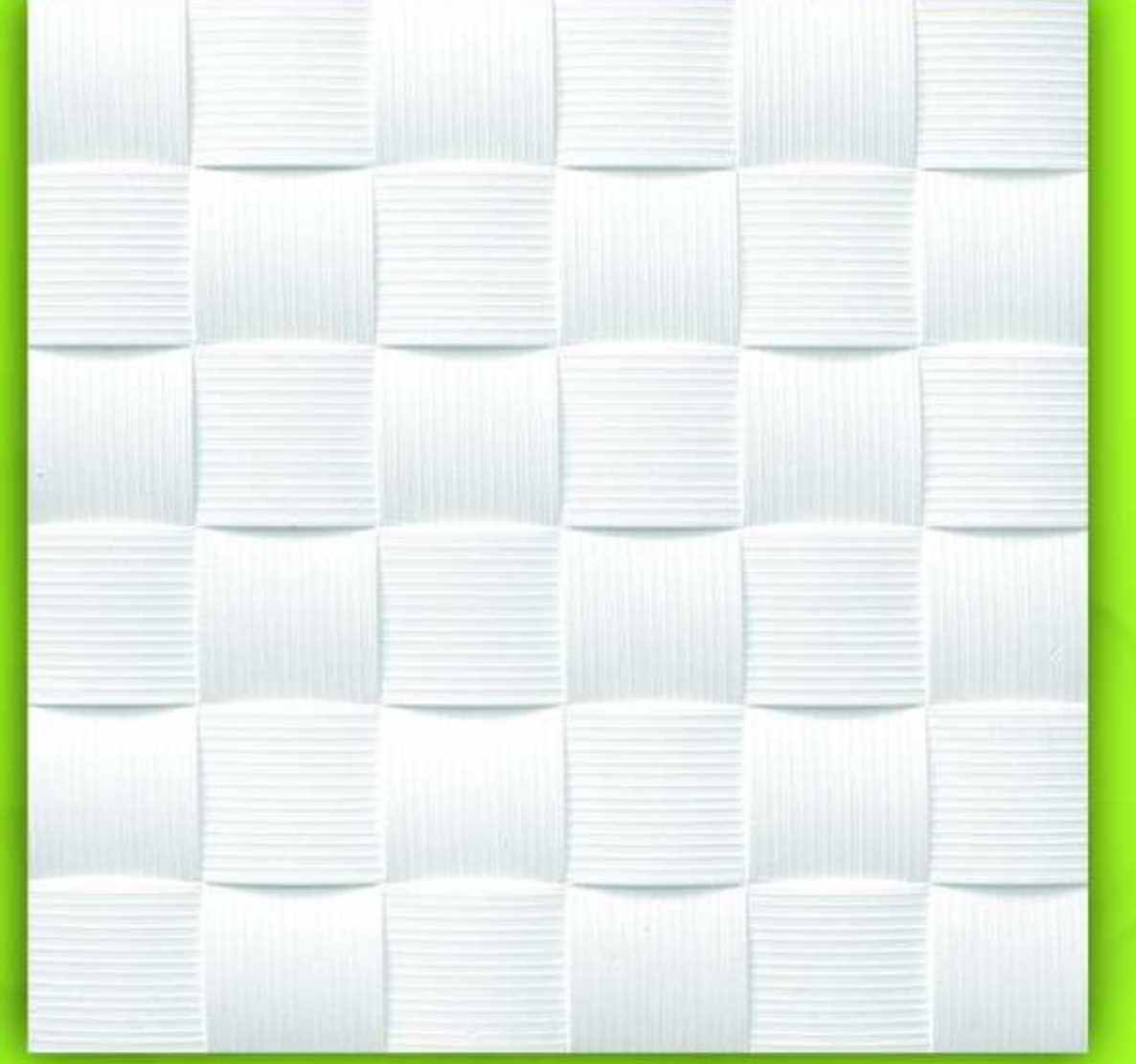

ASPENDOS 1113
50,2 cm x 50,2 cm



ÇIRALI 1114
50,2 cm x 50,2 cm

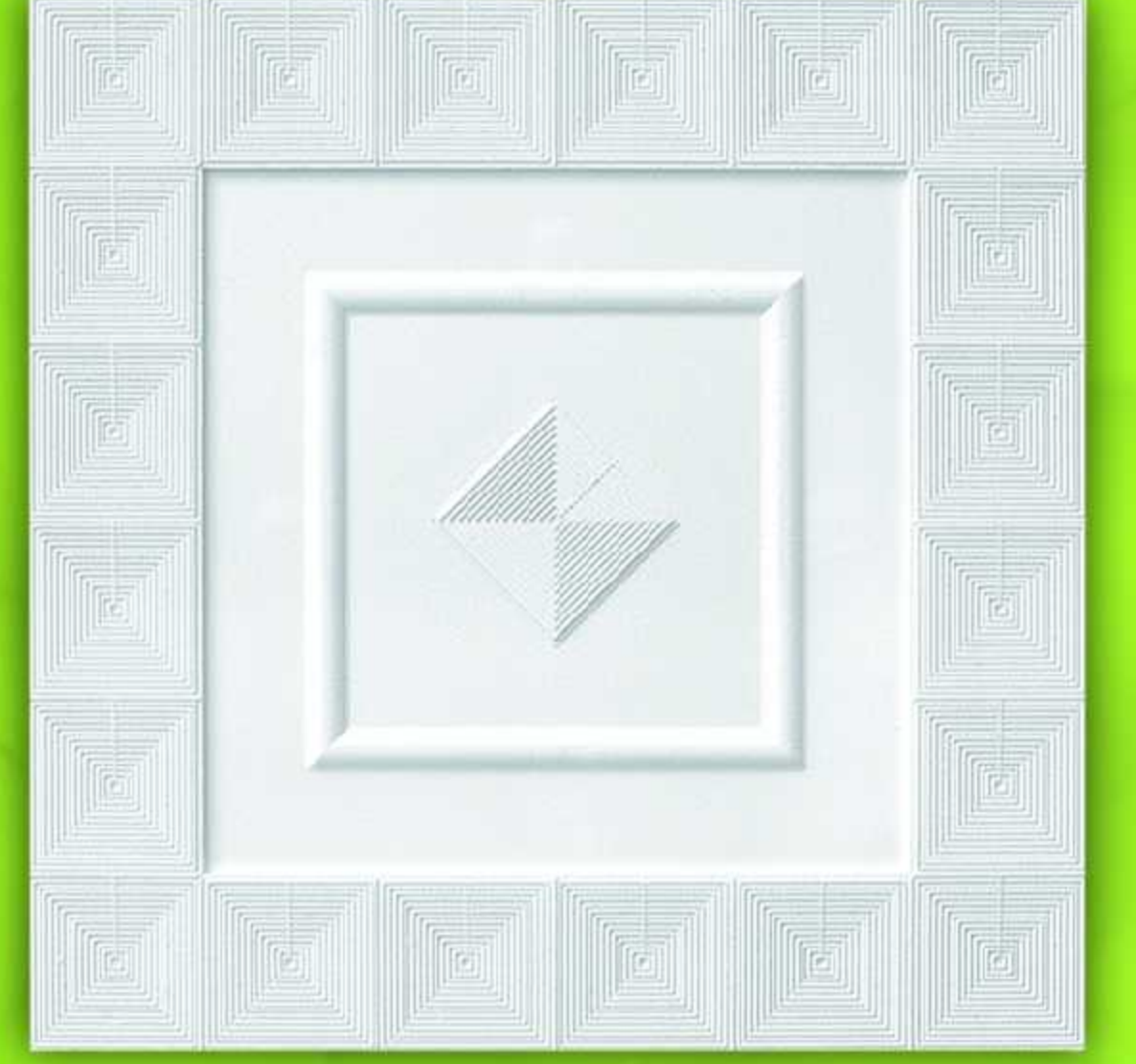

PERGE 1115
50,2 cm x 50,2 cm



DAMLATAŞ 1116
50,2 cm x 50,2 cm

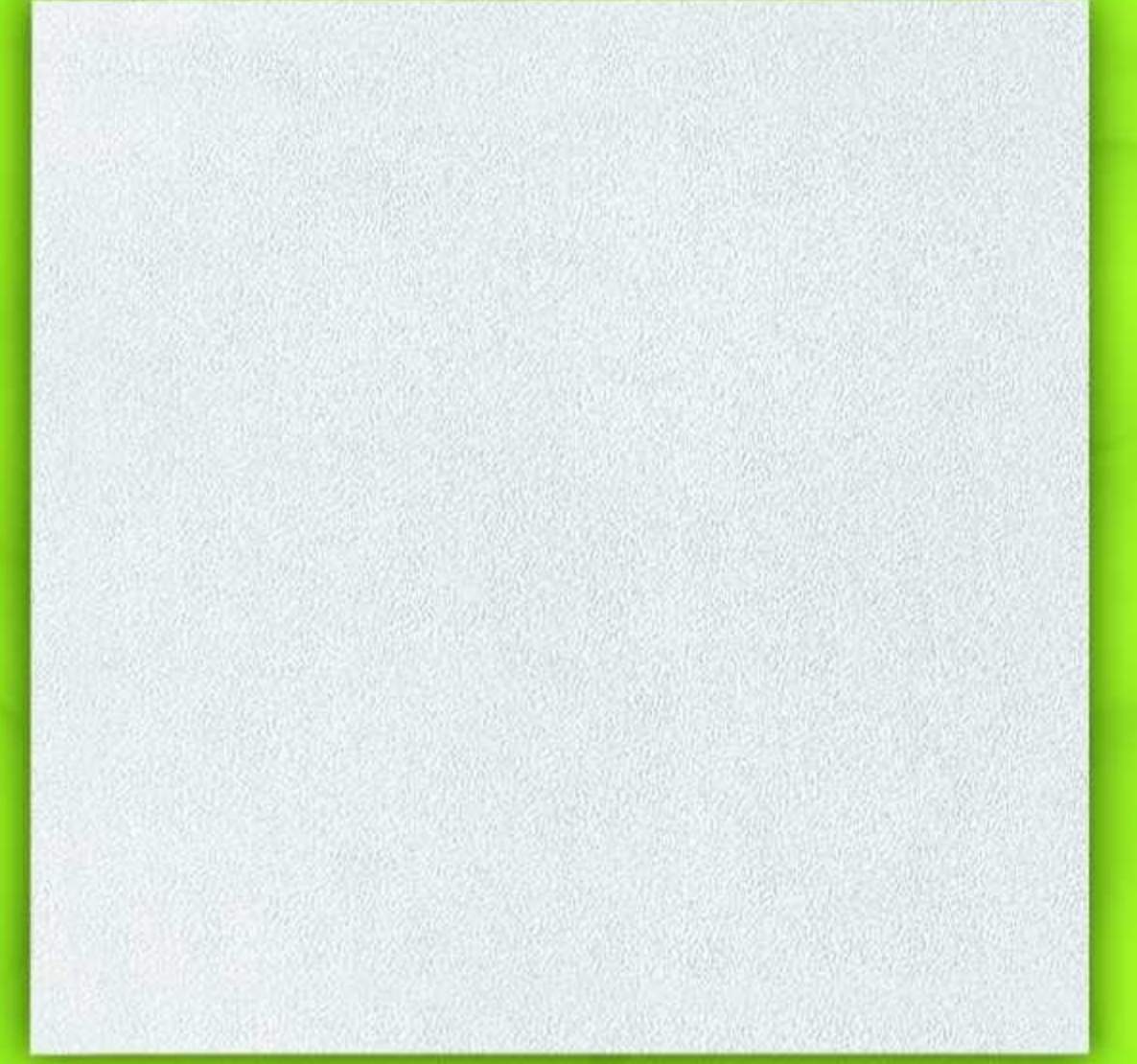

OLİMPOS 1117
50,2 cm x 50,2 cm

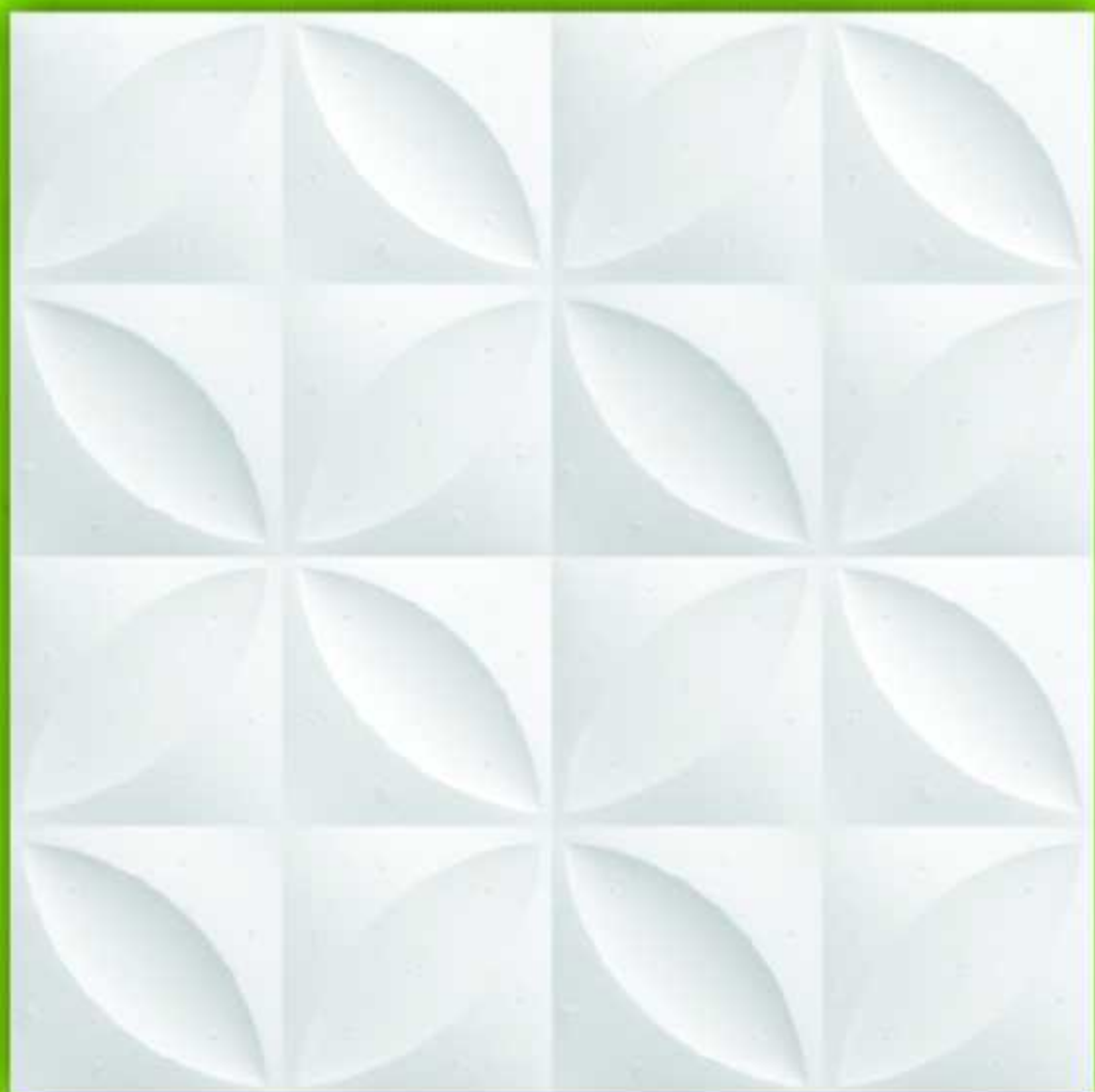

FALEZ 1118
50,2 cm x 50,2 cm



DÜDEN 1119
50,2 cm x 50,2 cm

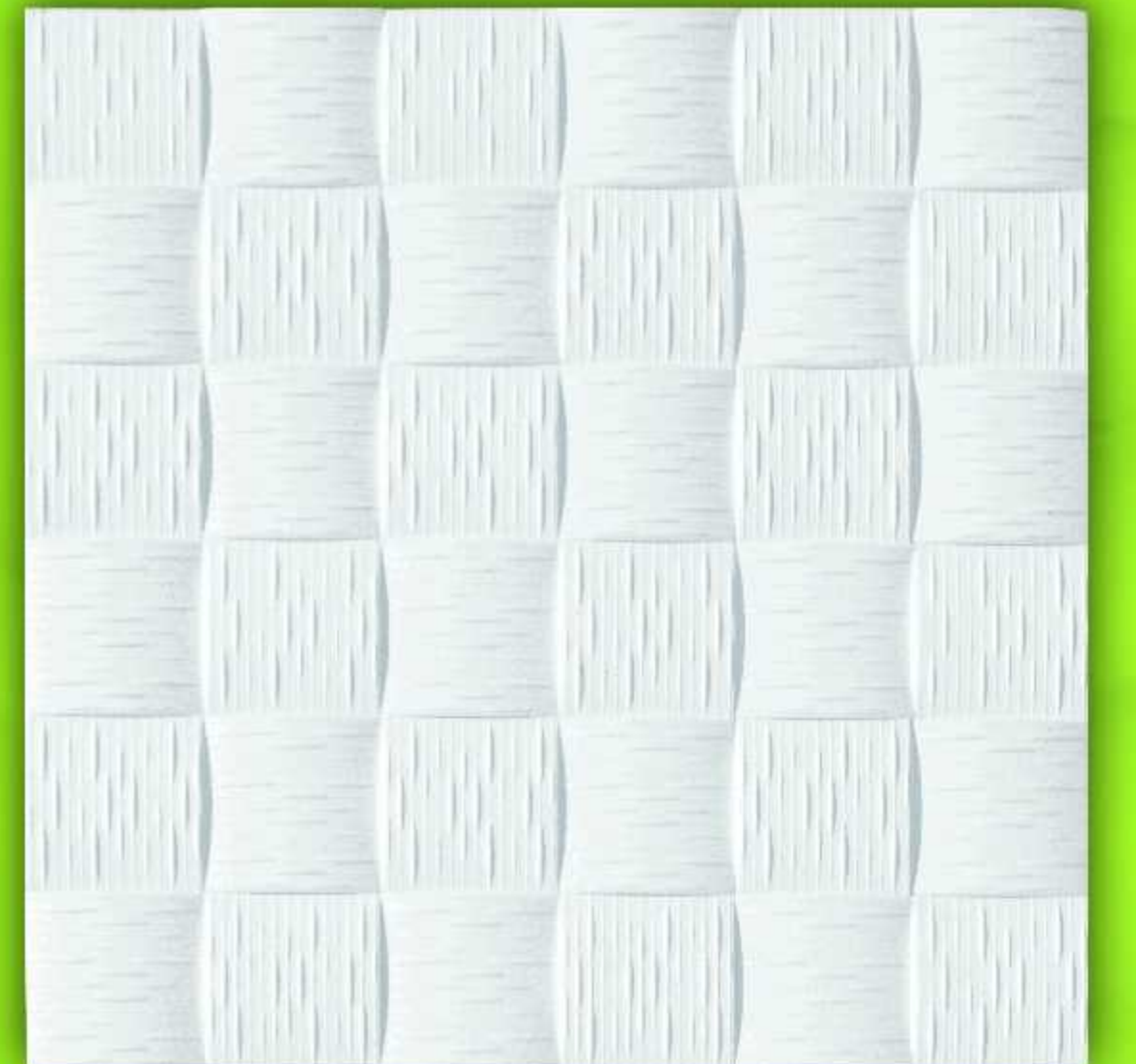

• Ürünlerimizin uygulaması HKS yapıştırıcılarımızla yapılmalıdır. / • Application of our products must be done with HKS adhesive

ASMA TAVAN PLAKALARI

Suspended Ceiling Plates

60 cm x 60 cm dekoratif asma tavan plakaları standart kalınlığında EPS polistren olup, enjeksiyon makinelerinde kalıplı üretim yapılmaktadır. Konstrüksiyonu yapılmış “T” profillere istenilen model yerleştirilir. Montajı kolay olup, istenirse üzeri su bazlı boya ile boyanabilmektedir.

60cmx60cm decorative suspended ceiling plates EPS polystyrene with standard thickness and produced in the injection machines with molds. Any model could be installed on constructed T profiles. It is easy to montage and could be painted with water based paint.

ASMA TAVAN PLAKASI
Suspended ceiling plate

T-24 PROFİLİ

KEMER 2001
59,5 cm x 59,5 cm

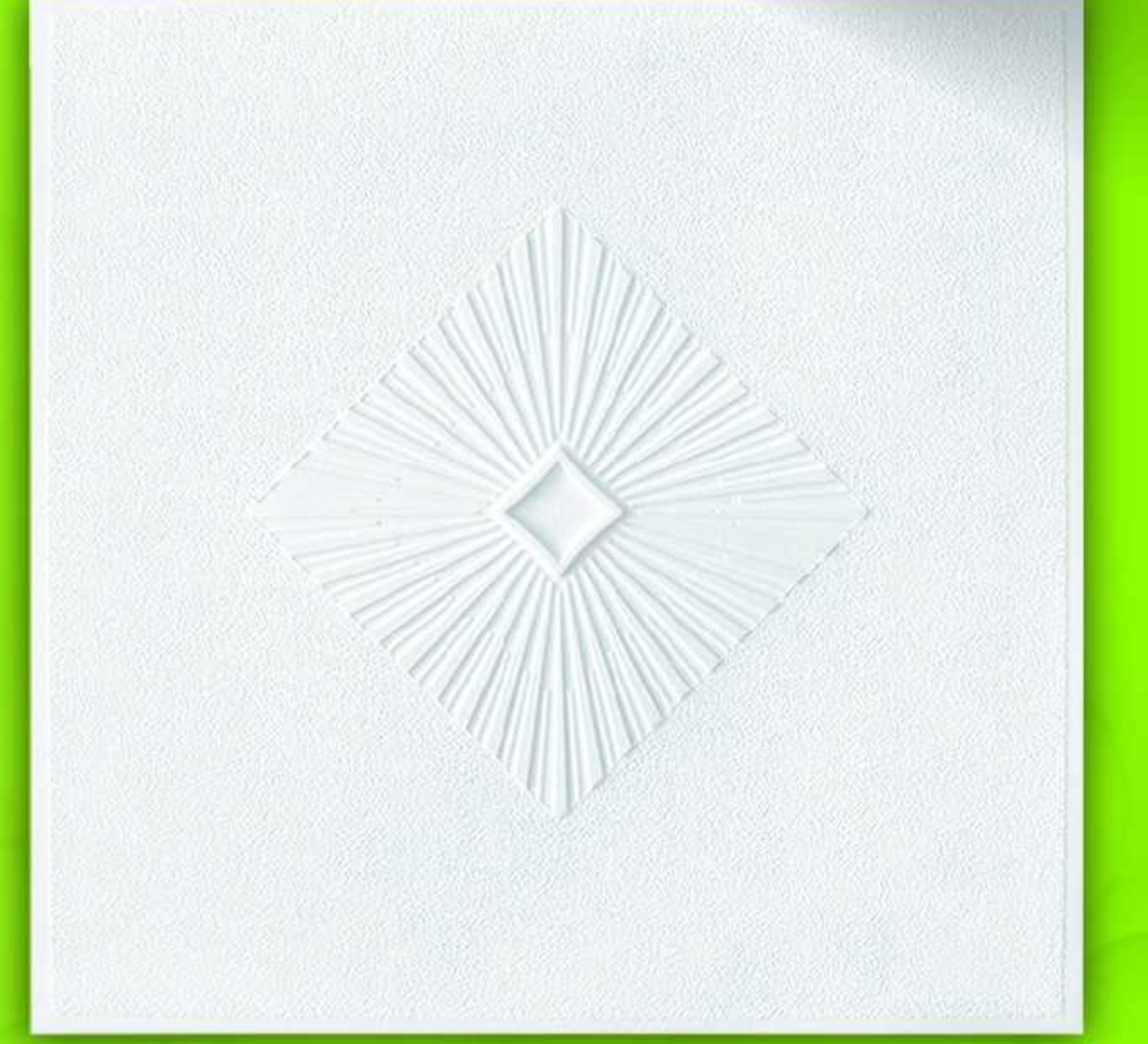

KAŞ 2002
59,5 cm x 59,5 cm



SİDE 2003
59,5 cm x 59,5 cm

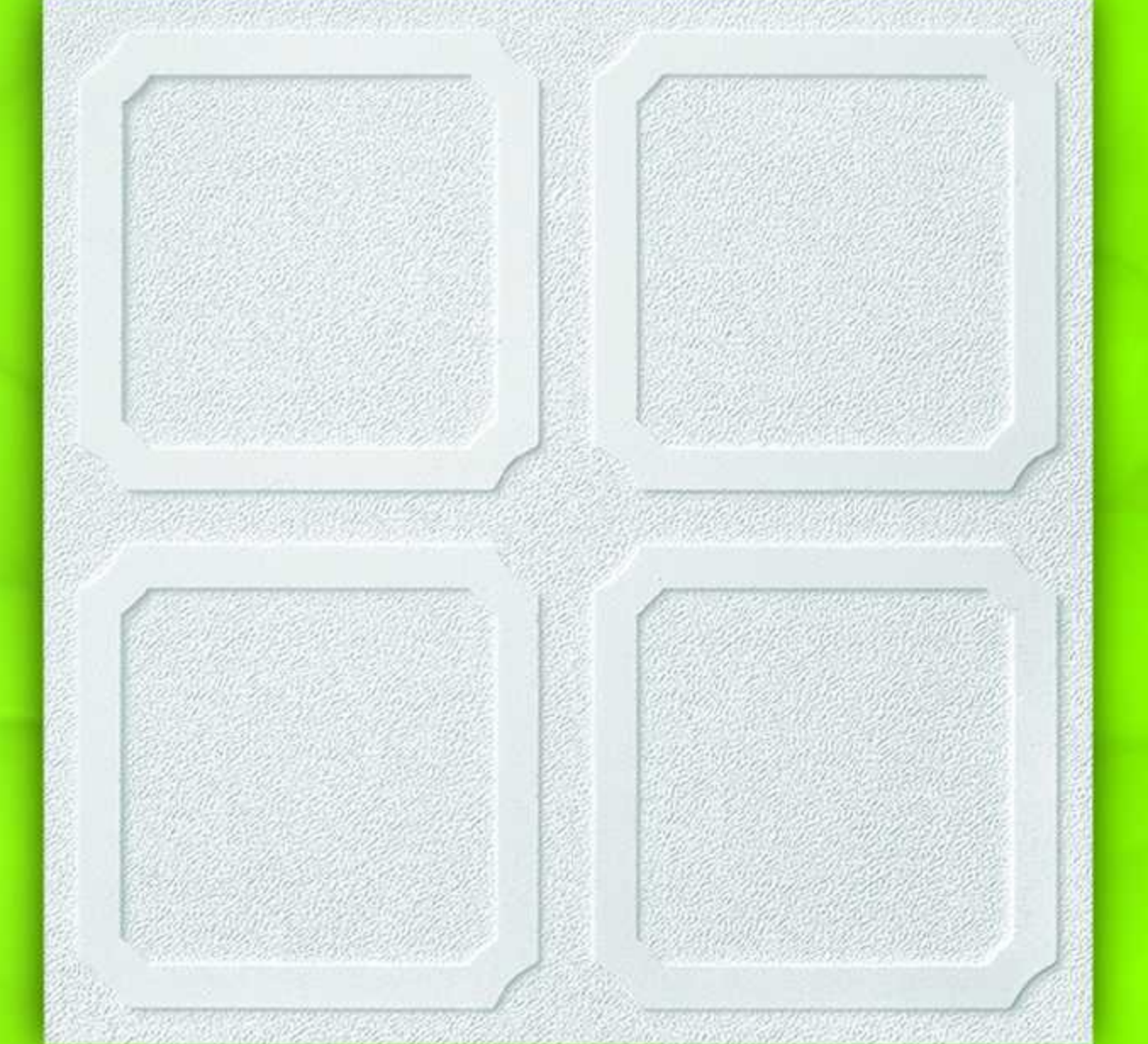

ALANYA 2004
59,5 cm x 59,5 cm

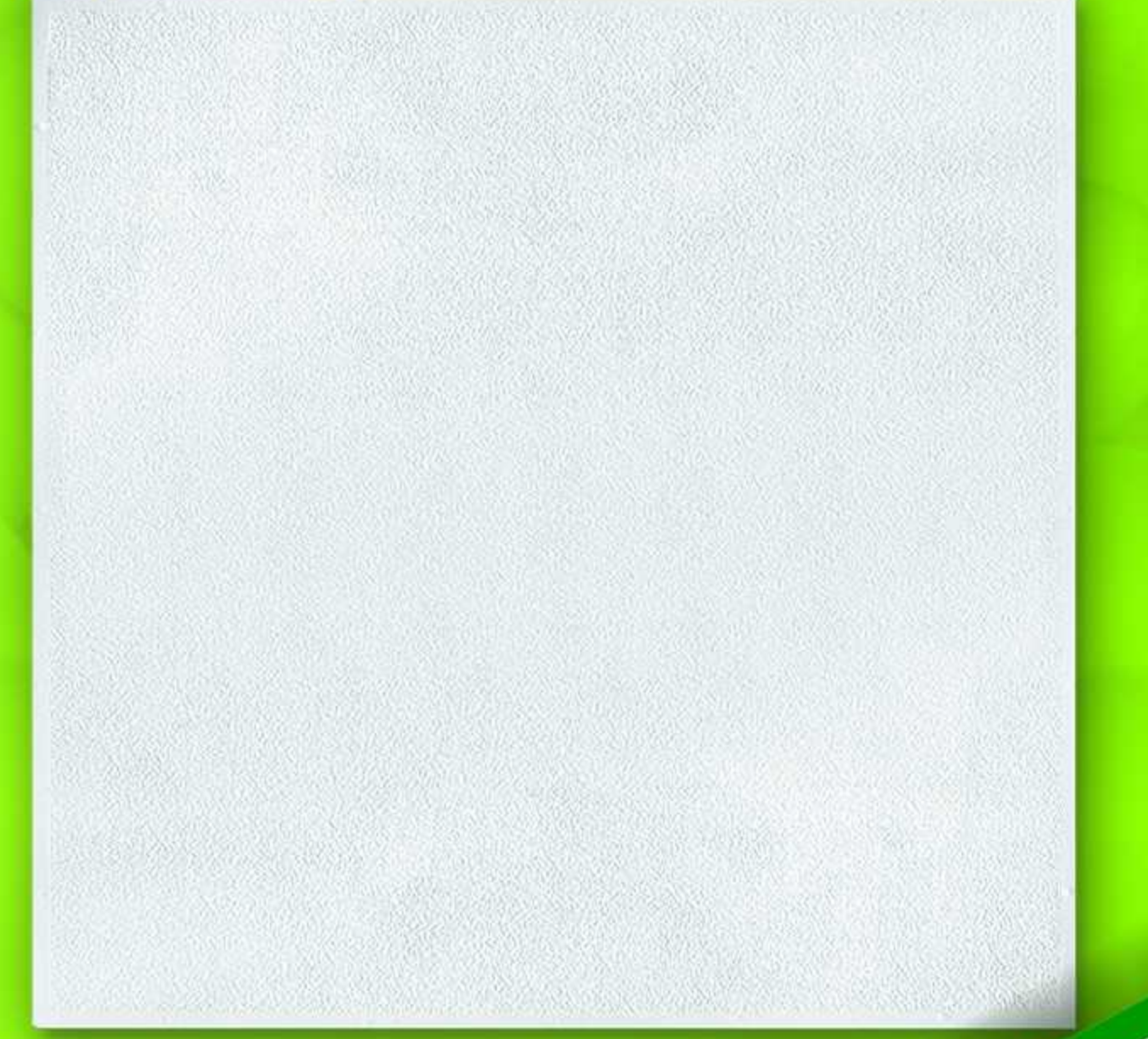

DESENLİ LAMBA GÖBEKLERİ

Figured Lamp Centers



KD 103
56,5 cm



KD 104
41 cm



KD 105
42 cm



KD 106
48 cm



KD 107
50 cm



KD 108
38 cm



KD 109
48 cm



KD 110
38 cm



KD 111
48 cm



KD 112
38 cm



KD 113
60 cm



KD 114
48 cm



KD 115
38 cm



LAMBA GÖBEKLERİ

Lamp Centers

C - 01
B. Çerçeve
52x52cm



C - 02
K. Çerçeve
52x52cm



KG 70
51 x 48 cm



KG 71
54 cm



KG 72
53 x 46 cm



KG 73
40 x 37 cm



KG 74
42 cm



KG 75
35 x 40 cm



KG 76
52 cm



KG 77
39 cm



KG 78
70 cm



KD 55
44,5 x 55cm



- Ürünlerimizin uygulaması HKS yapıştırıcılarımızla yapılmalıdır.
- Application of our products must be done with HKS adhesive.



AHŞAP TONOZ MODELLERİ

Wooden Vaults Models



AĞAÇ 24



AĞAÇ 27



AĞAÇ 29



AĞAÇ 28



AĞAÇ 23



AĞAÇ 16

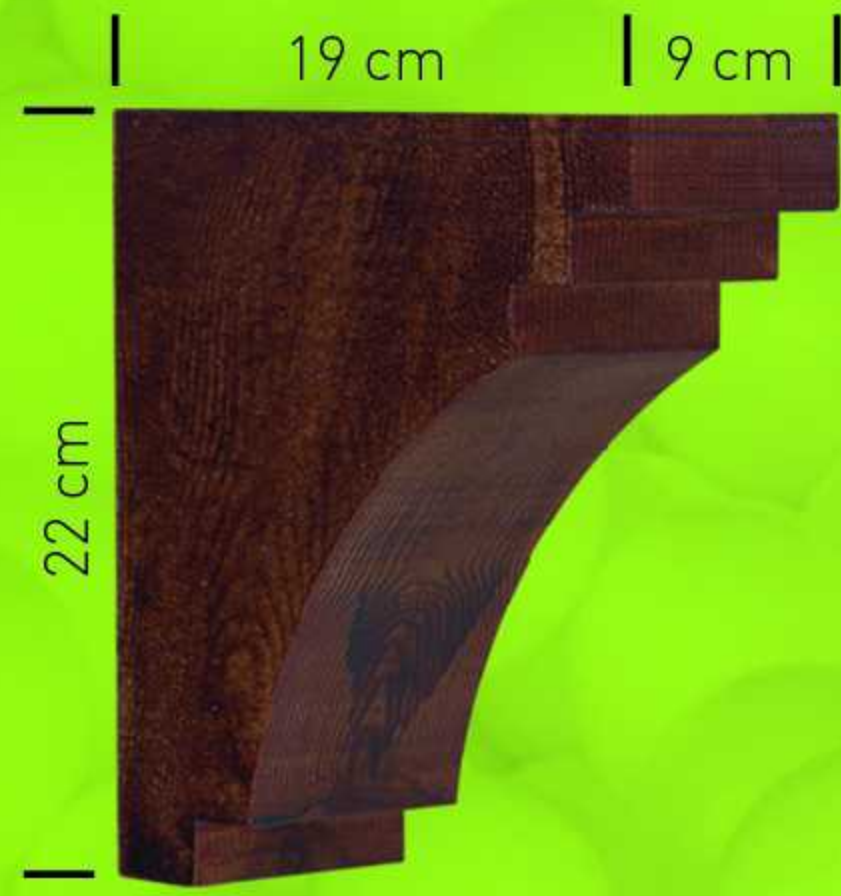

AĞAÇ 18



AĞAÇ 19

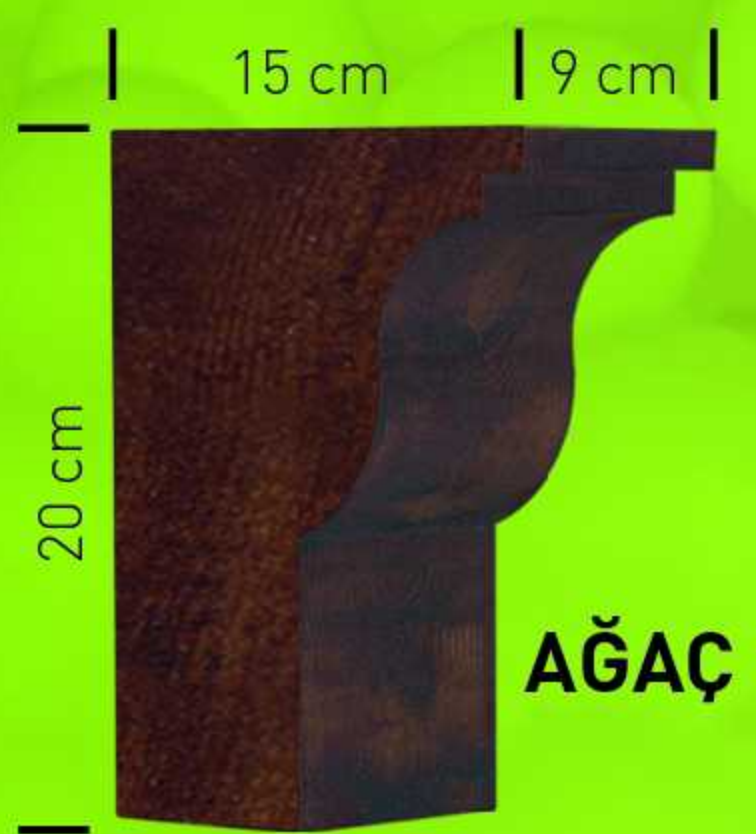

AĞAÇ 17



AĞAÇ 22



AĞAÇ 21



- Ürünlerimizin uygulaması HKS yapıştırıcılarımızla yapılmalıdır.
- Application of our products must be done with HKS adhesive.

AHŞAP PROFİL MODELLERİ

Wooden Profile Models



AĞAÇ 10

17 cm



AĞAÇ 11

12 cm



AĞAÇ 13

7 cm



AĞAÇ 12

2 cm



AĞAÇ 30

1,5 cm



AĞAÇ 15

4,5 cm



AĞAÇ 26

3 cm



AĞAÇ 25

4,5 cm



AĞAÇ 14

6 cm

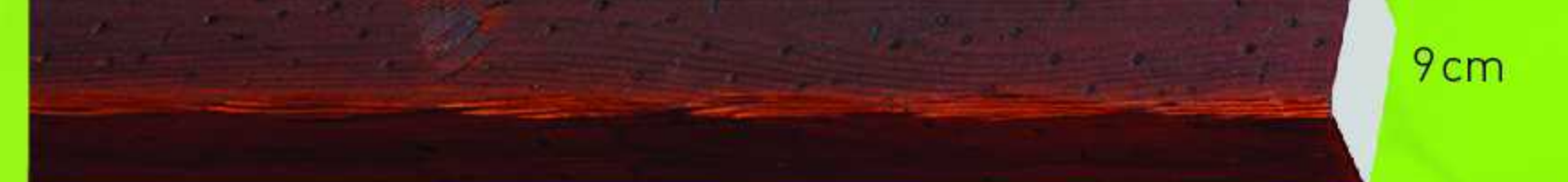

Standart boylar 200 cm 'dir - The standard length is 200 cm

- Ürünlerimizin uygulaması HKS yapıştırıcılarımızla yapılmalıdır.
- Application of our products must be done with HKS adhesive.

İÇ DEKOR UYGULAMA TEKNİKLERİ

Interior Decoration Application Techniques

TAVAN KAPLAMALARI

Ceiling Plates



1

- Öncelikle yüzey uygulamaya hazır hale getirilir.
- HKS akrilik mastik malzeme, yüzey üzerine fazla kenarlara taşmadan küçük toplar halinde uygulanır.

The surface is prepared for application. HKS acrylic mastic is applied on the material as small balls avoiding applying on the edges.



2

- Kapı girişinin karşısındaki köşeden yapıştırıcı dışarı taşırılmadan (ek parçaların göze batmaması için) uygulamaya başlanır.

The adhesive is not effused and application begins from the corner at the entrance (for preventing the parts do not offend the eyes).

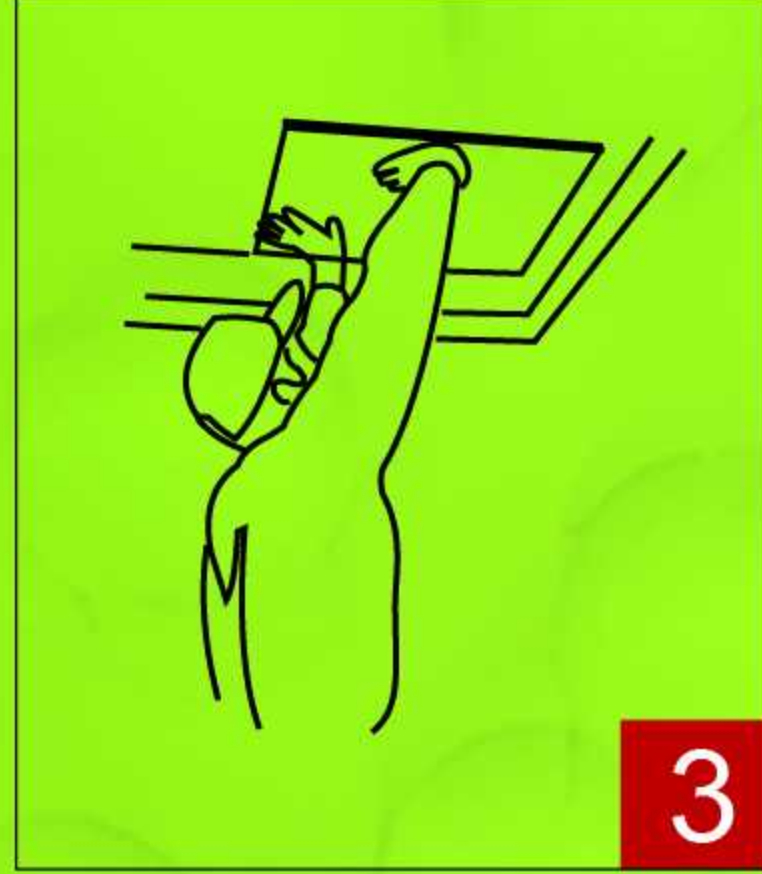

3

- Yapıştırma sırasında malzeme fazla baskı yapılmadan plaka sağa-sola oynatılarak yapıştırıcının zemine yayılması sağlanır.

The material should not be applied overpressure during bonding and it should be ensured that the adhesive is scattered on the surface by moving the plate right and left.



4

- İki malzeme arasında dolgu yapılmamalı ve tavan yapıştırıcısı derz olarak kullanılmamalıdır.
- Tavan eğriliği dikkate alınmalı, yapıştırıcı ile dolgu yapılarak, baskıyla kendi içinde çözümü sağlanır.

No filling should be applied between two materials and effused adhesive should not be used as suture. Unevenness of the ceiling should be considered and solved on its own by filling with adhesive.

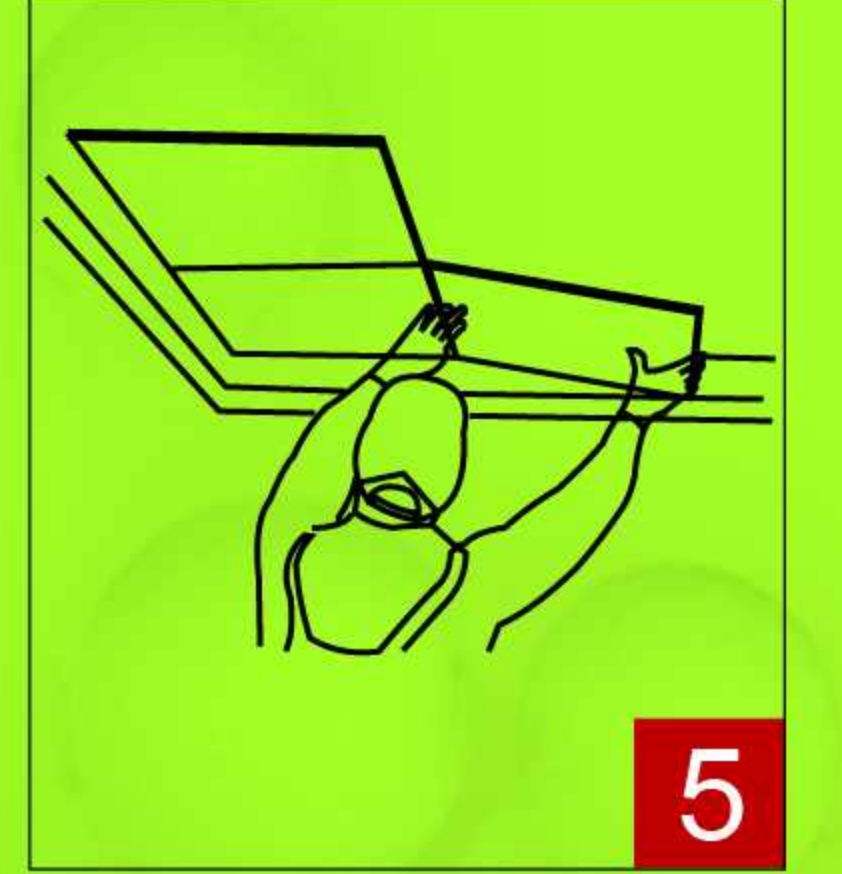

5

- Uygulama, tek bir köşeden başlayıp, sistematik bir şekilde devam ettirilir.

The application should begin from a corner and be continued systematically.

ASMA TAVAN PLAKALARI

Suspended Ceiling Plates



1

- Tavandan kot alınıp, teraziye alınır.
- "T-24 Profilleri" kullanılarak, taşıyıcı konstrüksiyonu yapılır.

The ceiling is graded and balanced. The construction is performed by using bearer "T-24 Profiles"



2

- 60x60 plakalar, düzgün bir şekilde profilin üzerine yerleştirilir.

60x60 plates are smoothly placed on the profile.



3

- Metrekareye 5 adet gelecek şekilde profil üzerine klips takılarak, malzemenin yerinden oynaması engellenir.

It is prevented that the materials get loose by attaching 5 clips per square-meter of profile.

LAMBA GÖBEKLERİ

Ceiling Lamp Centers



1

- HKS-Fix toz yapıştırıcı suya, 1'e 1,5 oranında serpilerek, yoğurt kıvamına gelene kadar karıştırılır.
- Donma süresi; normal hava şartlarında ortalama 45 dakikadır.
- Yapıştırma ve rötuş işleminde kullanılır.

HKS-Fix dust adhesive is added to water in 1 to 1,5 rate and mixed until has a yoghurt formation. Freezing time is average 45 minutes in normal weather conditions. Used in bonding and retouching processes.



2

- HKS-FIX toz yapıştırıcı, bir spatula yardımıyla kenarlara sürülür.

HKS-FIX dust adhesive is applied on the sides by a spatula.

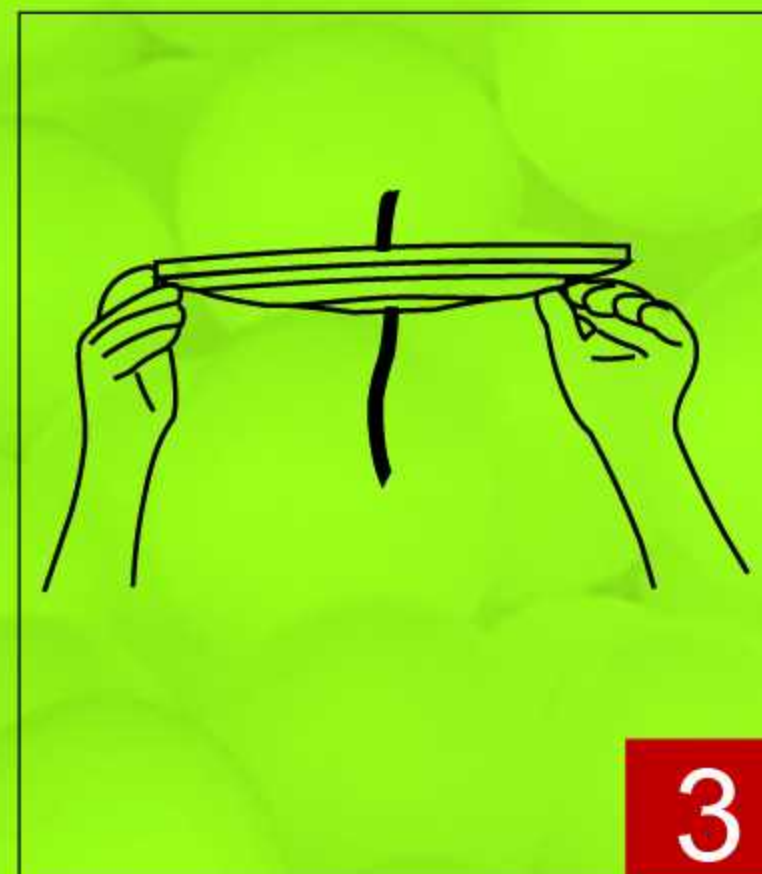

3

- Malzeme ortalanıp, hafifçe bastırılarak ve sağa sola oynatılarak, uygulama yapılır.
- Sürülen yapıştırıcının, kenarlarından taşması sağlanır.

The material is applied by centering, gently pushing and moving rightwards and leftwards. It is ensured that the applied adhesive is effused from the sides.



4

- Dışarı tavan yapıştırıcıların, tavanla göbek arasındaki kısmına, eşit şekilde dolgu yapılması sağlanır.

It is ensured that the effused adhesive is filled in the section between the ceiling and the center equally.



5

- Sulu bir fırça kullanılarak, malzemenin etrafına taşan yapıştırıcılar temizlenir.

The adhesive effused around the material is cleaned by using a wet brush.

KARTONPİYER Moulding



- Yapılacak yüzey uygulamaya hazır hale getirilir.
- Seçilen kartonpiyer modelinin basar ölçüsüne göre ölçü alınıp, işaretlenir.
- Boyalı ip kullanılarak, montaj çizgisi belirlenir.

The surface is prepared for application. The measurements are taken and marked according to the tread of the selected moulding model. Montage line is determined by using a painted fiber.



- Kesim aparatı kullanılarak, iç ve dış gönyeler hazırlanır.

Inner and outer miters are prepared by using a cutting apparatus.



- HKS-Fix toz yapıştırıcı suya, 1'e 1,5 oranında serpiştirilerek, yoğurt kıvamına gelene kadar karıştırılır.
- Donma süresi; normal hava şartlarında ortalama 45 dakikadır.

HKS-Fix dust adhesive is added to water in 1 to 1,5 rate and mixed until has a yoghurt formation. Freezing time is average 45 minutes in normal weather conditions. Used in bonding and retouching processes.



- İki malzemenin birleşim yerine gelen kısımlarına, mutlaka yapıştırıcı sürülmeli ve dışarı taşması sağlanmalıdır.(çatlama riskini önlemek amacıyla)

Adhesive must be applied at the joints of two materials and adhesive should be effused. (for avoiding risk of cracking)



- İşaretlenen hiza üzerine malzeme yapıştırılır.
- Malzeme birleşim yerlerinin aynı hizaya getirilmesine ve figürlerin ağız ağıza gelmesine dikkat edilir.

Material is bonded through the marked line. It is paid attention for aligning the joints of materials and interlock the figures.

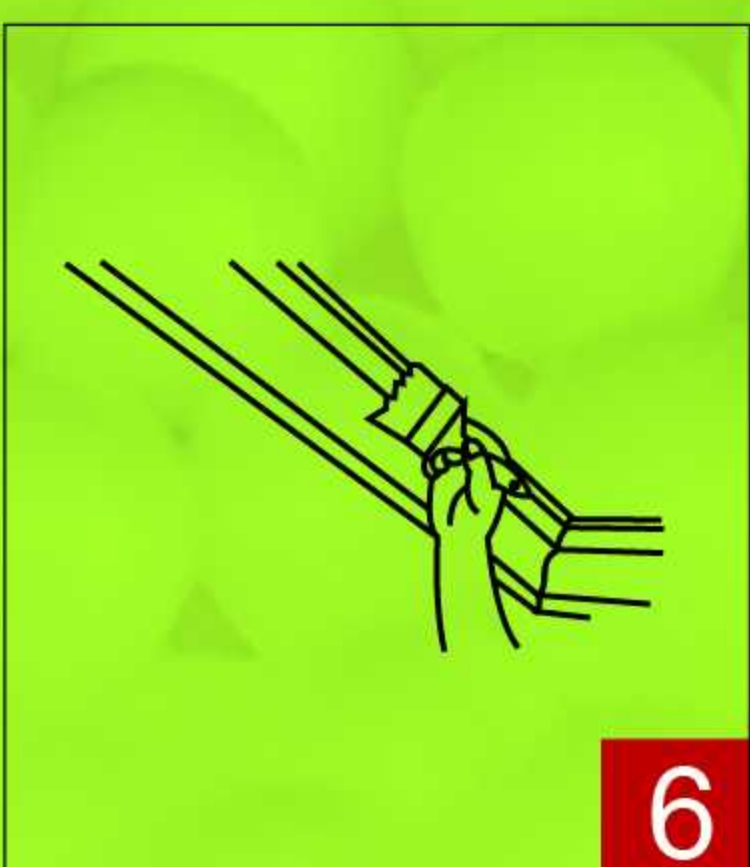

- Sulu fırça yardımıyla, ek yerleri ve temas bölgelerindeki pürüzler giderilir.
- İlk temizlik aşamasından 2-4 saat sonra, ek yerleri ve köşe merkezleri tekrar rötuşlanmalıdır.

The burrs on the joints and contacts are corrected by a wet brush. The joints and corners should be retouched after 2 or 4 hours from the first cleaning.

AHŞAP MODELLER Wooden Models



- Montaj yapılacak yerin ölçü ve kotu alınarak işaretleme yapılır. Yapıştırılacak zemin yapıştırıcı speklerine göre hazırlanır.

The marking is done by performing the elevation and measurement of the place of mounting. The surface to be bonded is prepared in accordance with the specifications of the adhesive.



- Ürünün yapıştırılacak yüzeylerine kenarlarından taşma yapmadan ihtiyaç duyulduğu kadar yapıştırıcı sürülür.

Required amount of adhesive is applied on the surfaces of the product without effusing.



- Ürün işaretleme yapılmış olan zemine tatbik edilir. Ahşap görüntüsünün bozulmaması için birleşme yerlerine hiçbir işlem yapılmaması gerekir.

The product is applied on the marked surface. No-process should be performed on the joints in order not to distort wooden image.

İÇ DEKOR YARDIMCI ÜRÜNLER

Auxiliary Products of Interior Decoration



Kesim Aparatı
Cutting Apparatus



HKS Özel mastik 500gr
HKS Special Mastic 500gr



HKS Fix 2 kg
HKS Fix 2 kg

HKS Fix 5 kg
HKS Fix 5 kg

HKS Fix 10 kg
HKS Fix 10 kg



CEPHE KAPLAMALARI

Exterior Sidings



CK Ahşap 701
CK wood



CK Ahşap 702
CK wood

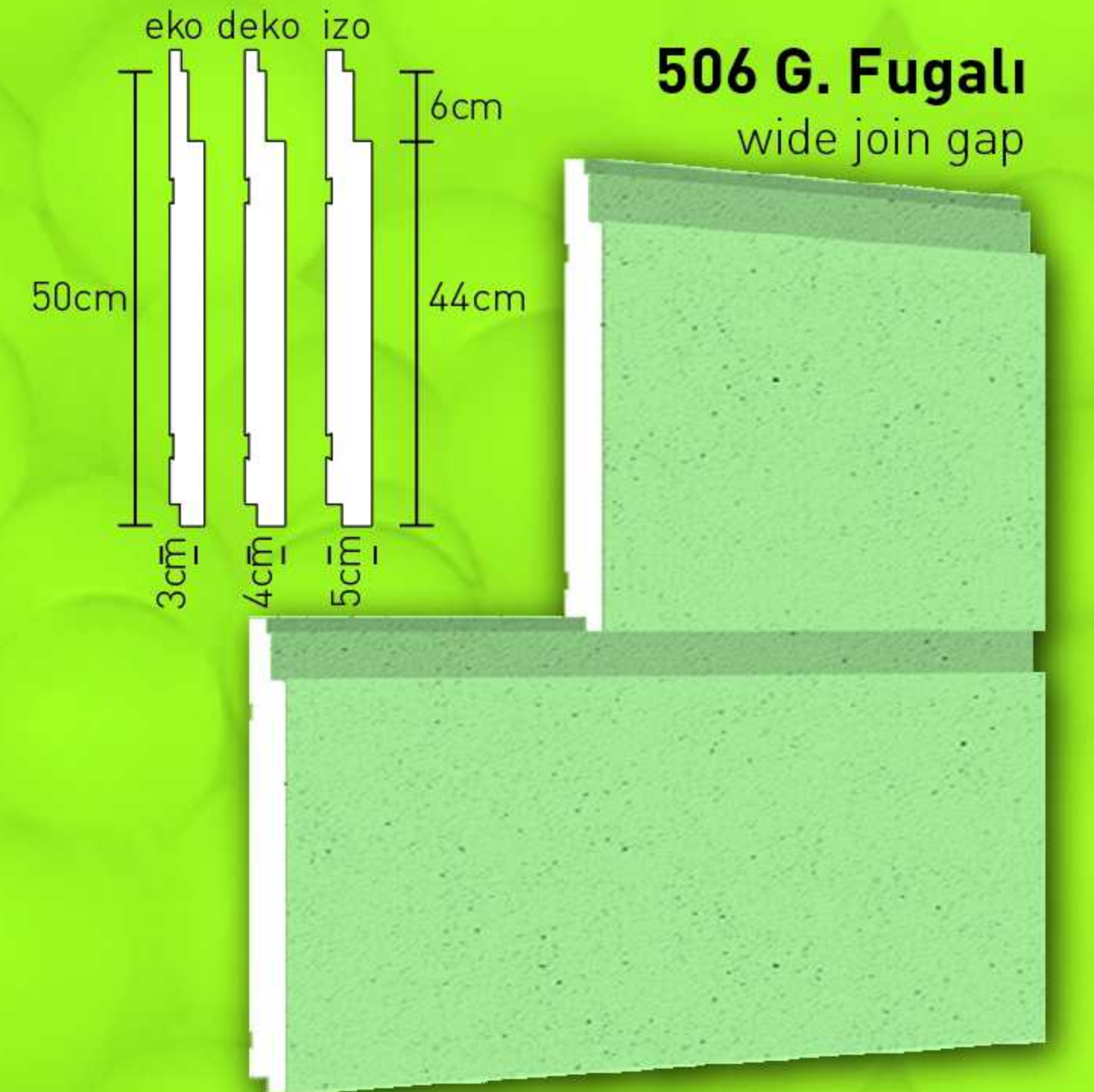
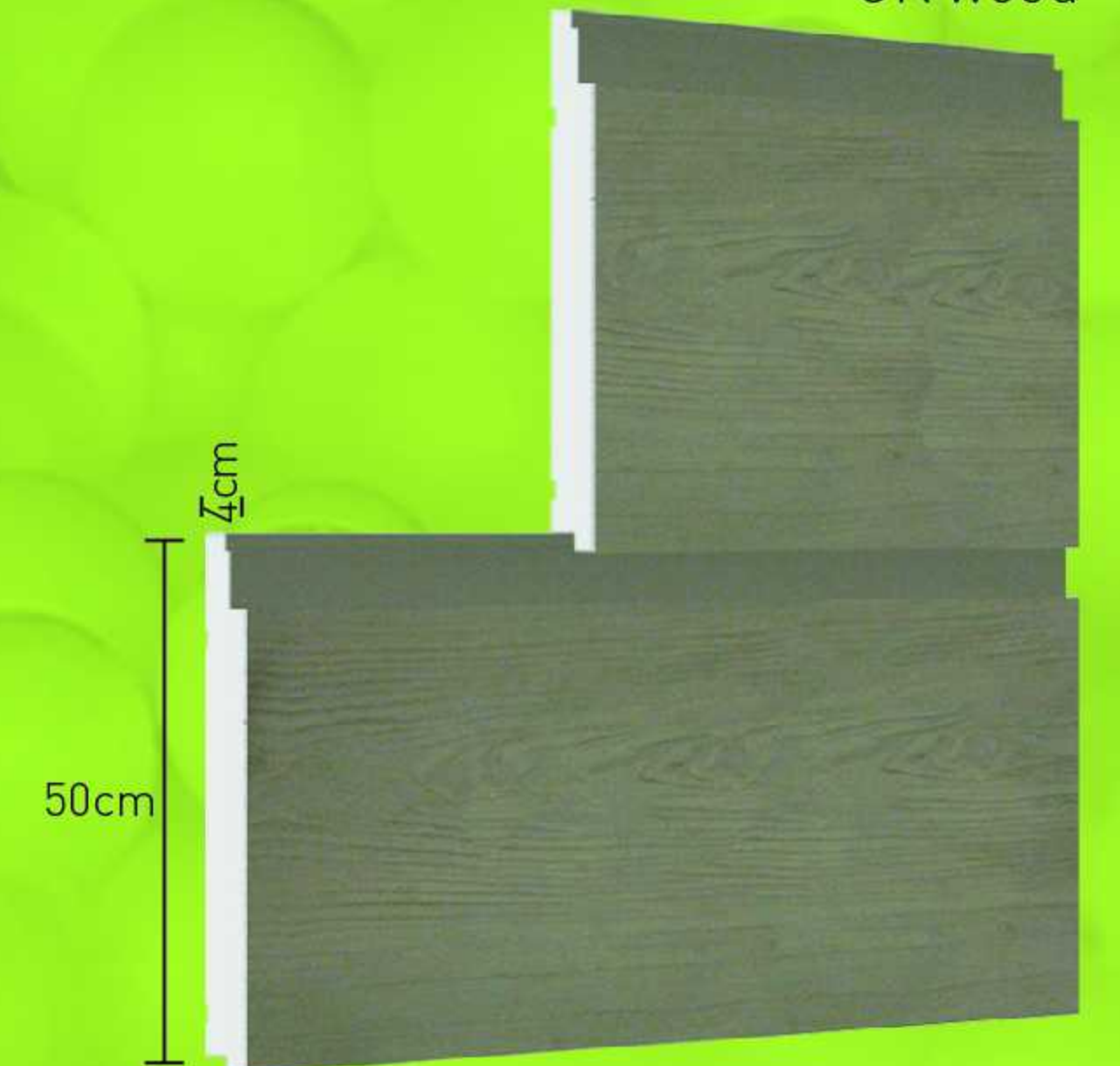

511 Desenli Taş Kaplama
figured stone paving



120 cm

510 Taş Kaplama
stone paving

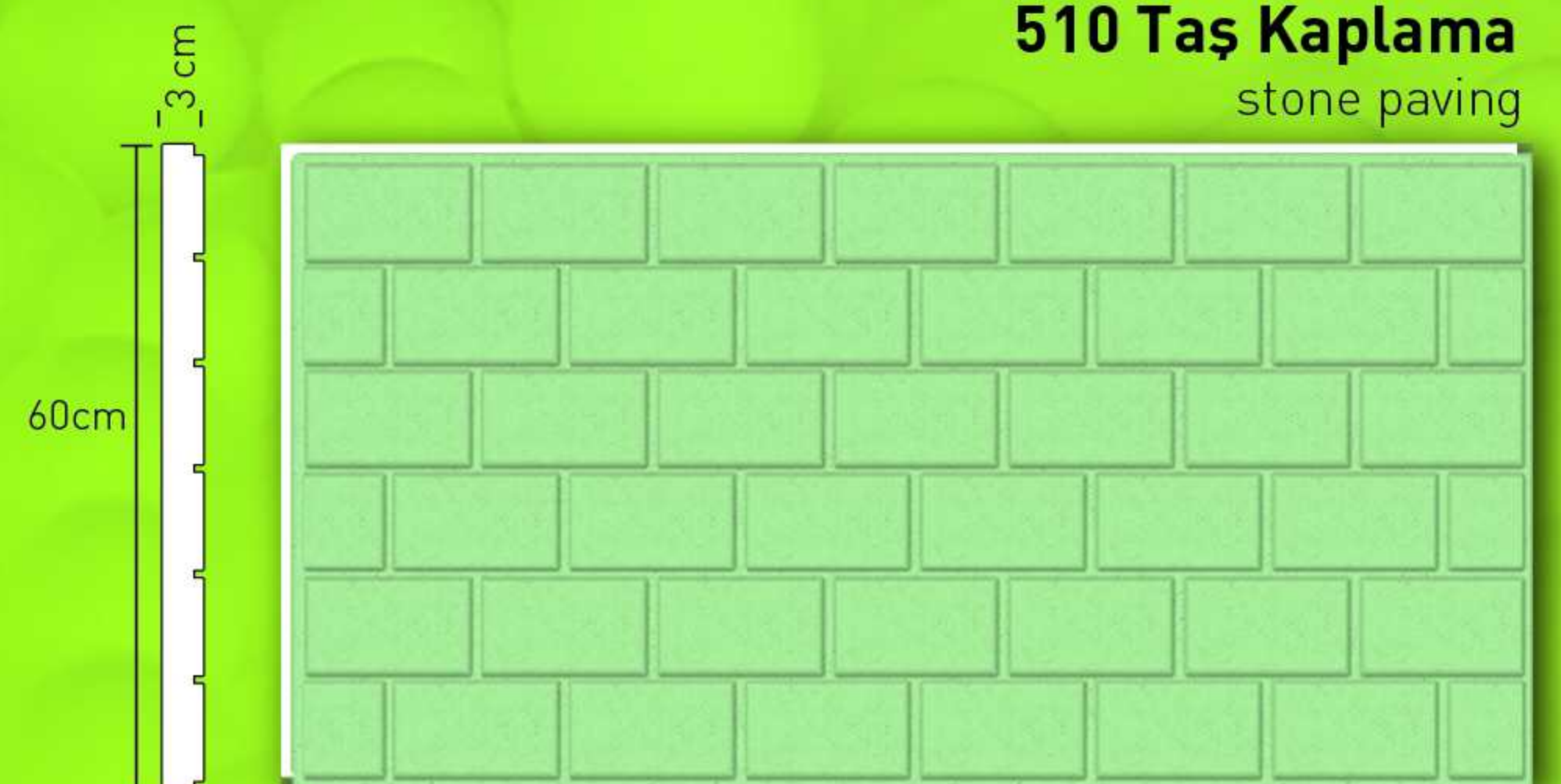

120 cm

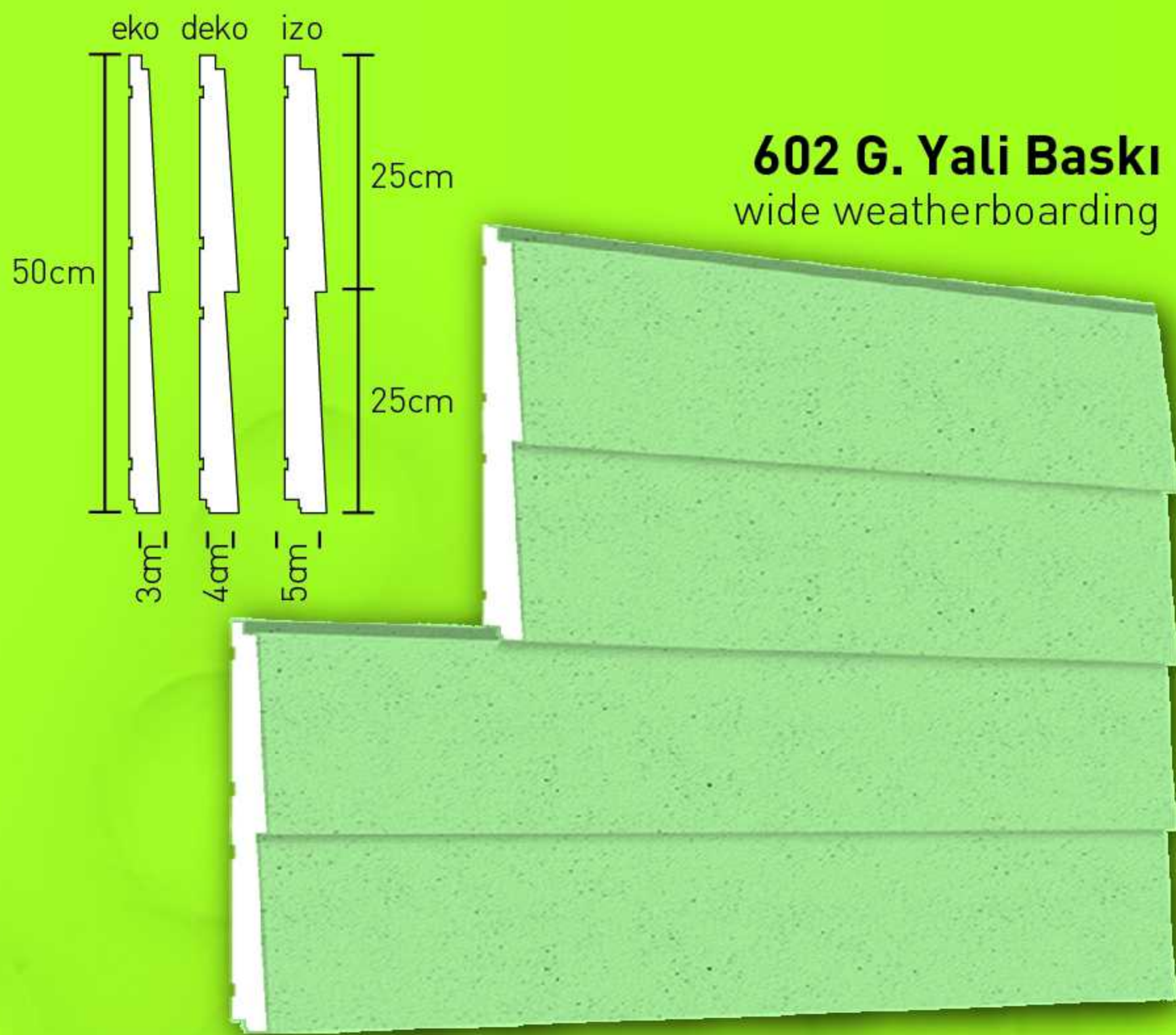

602 G. Yali Baskı
wide weatherboarding

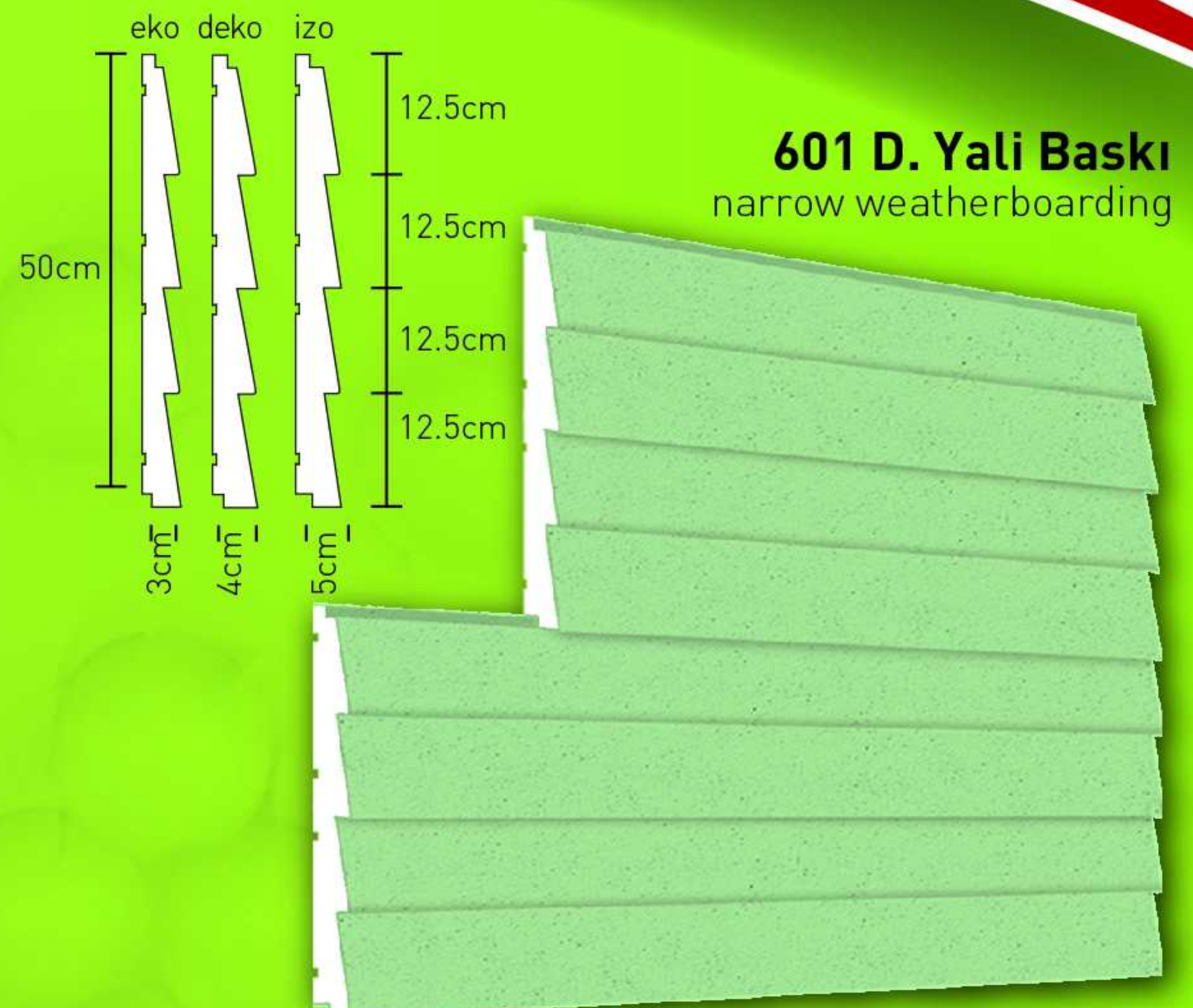

601 D. Yali Baskı
narrow weatherboarding

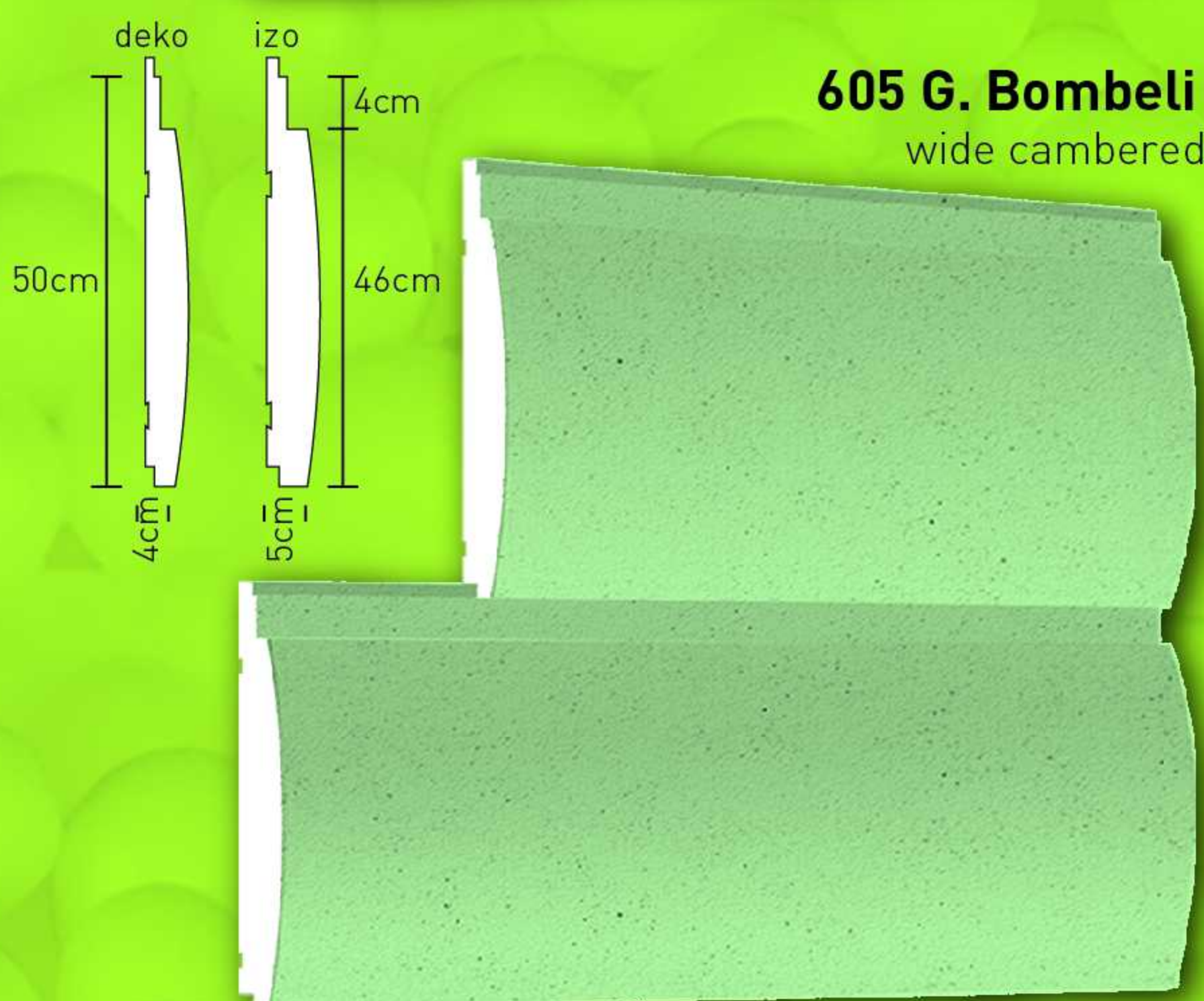

605 G. Bombeli
wide cambered

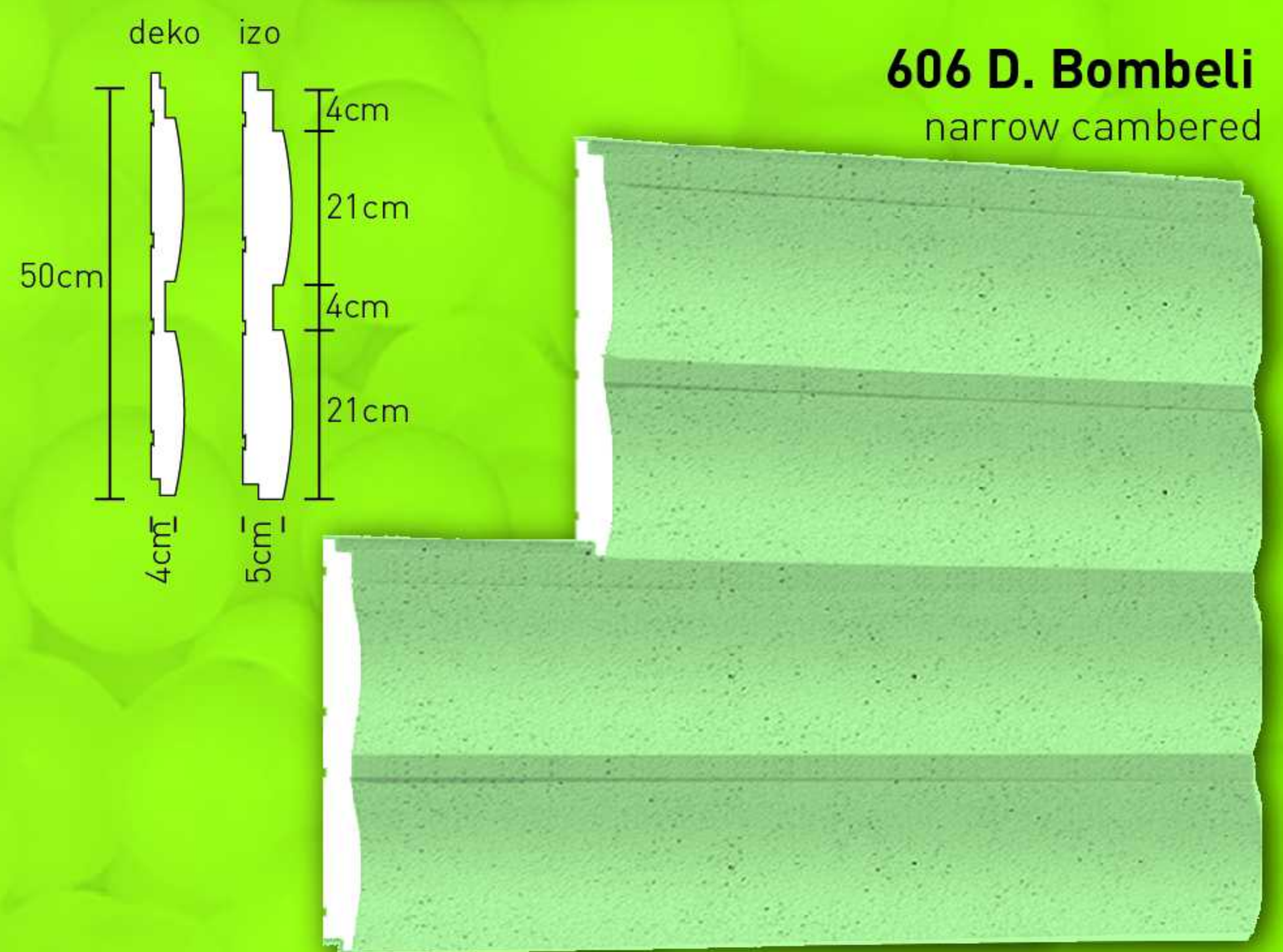

606 D. Bombeli
narrow cambered

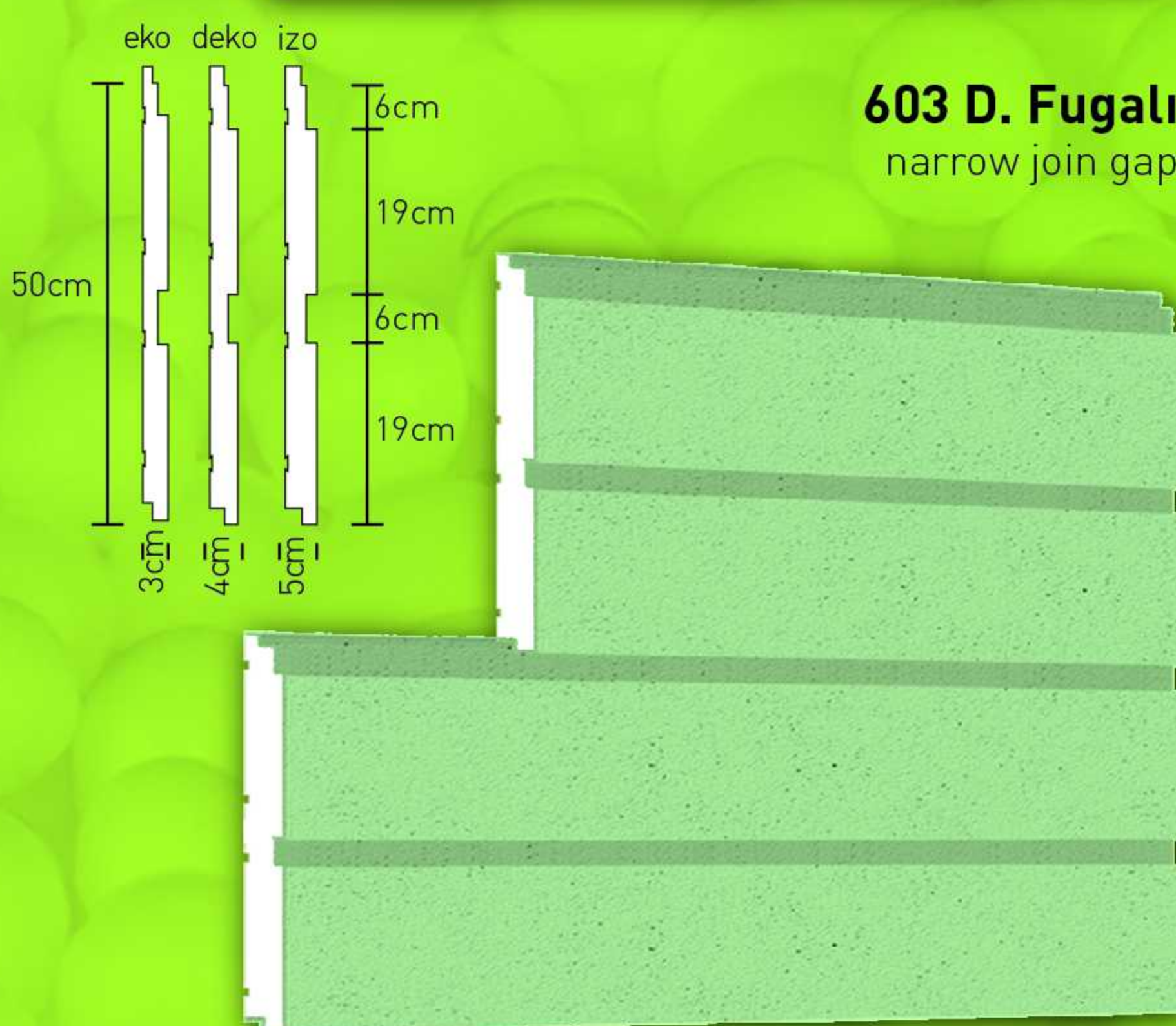

603 D. Fugali
narrow joint gap

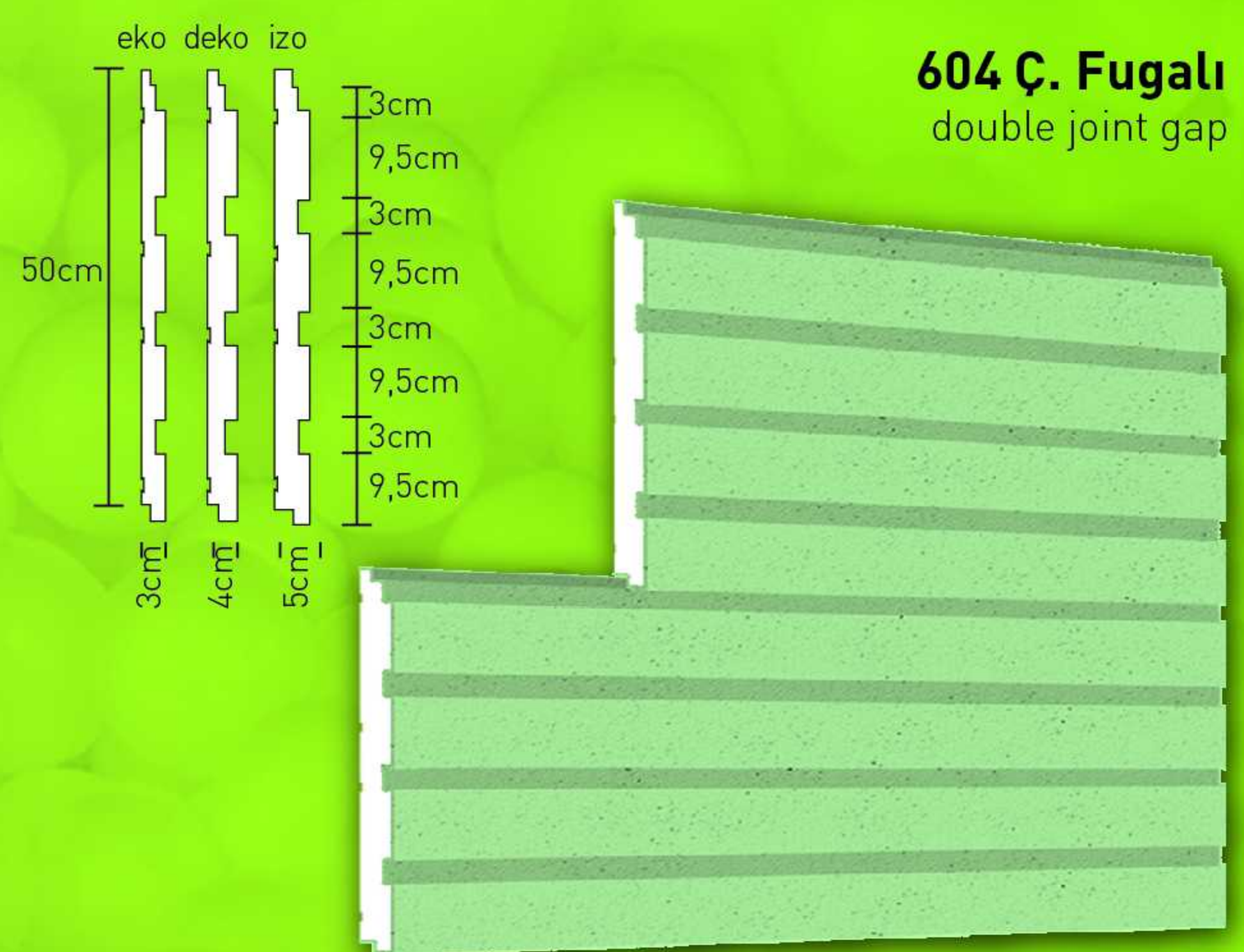

604 Ç. Fugali
double joint gap

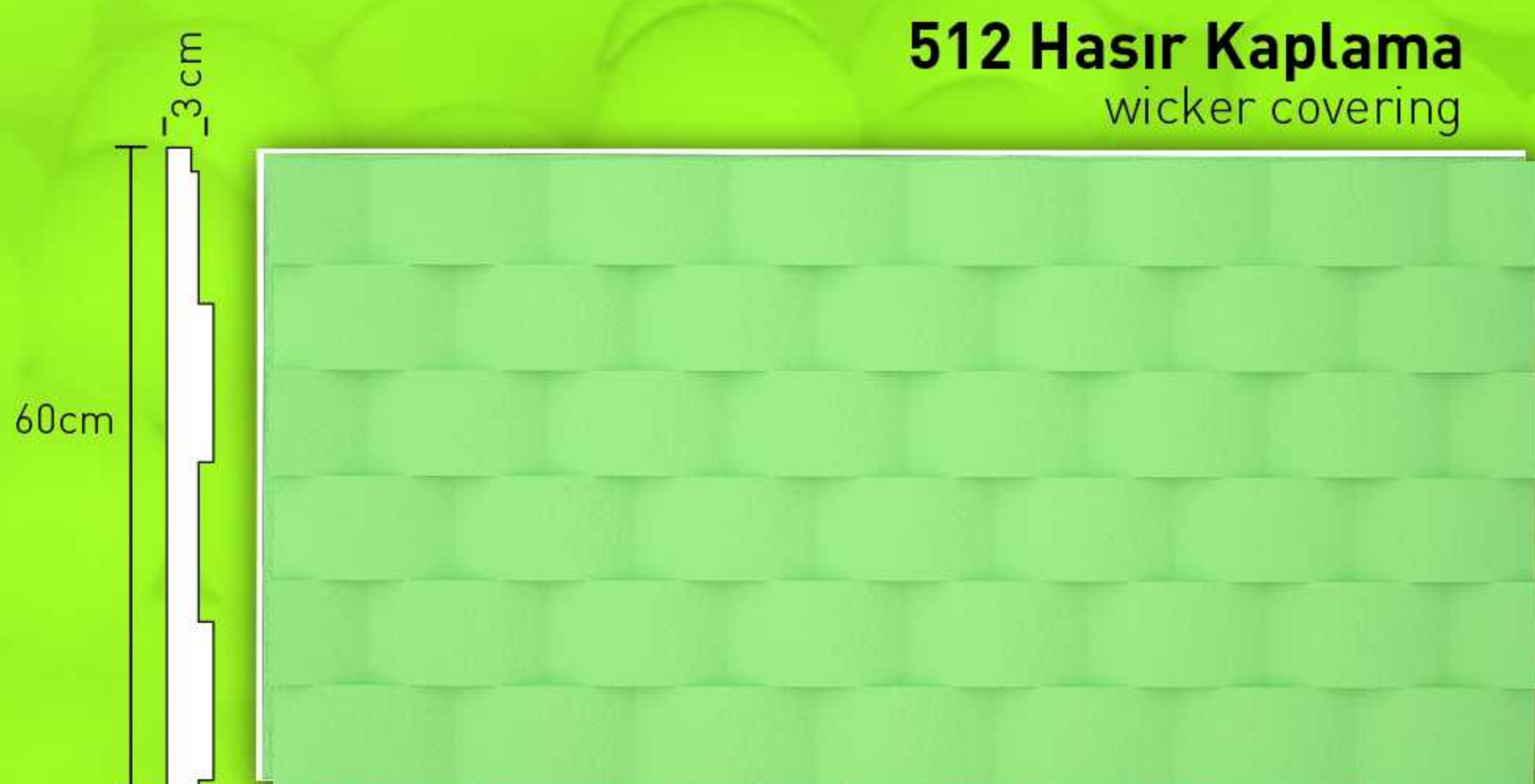

512 Hasır Kaplama
wicker covering

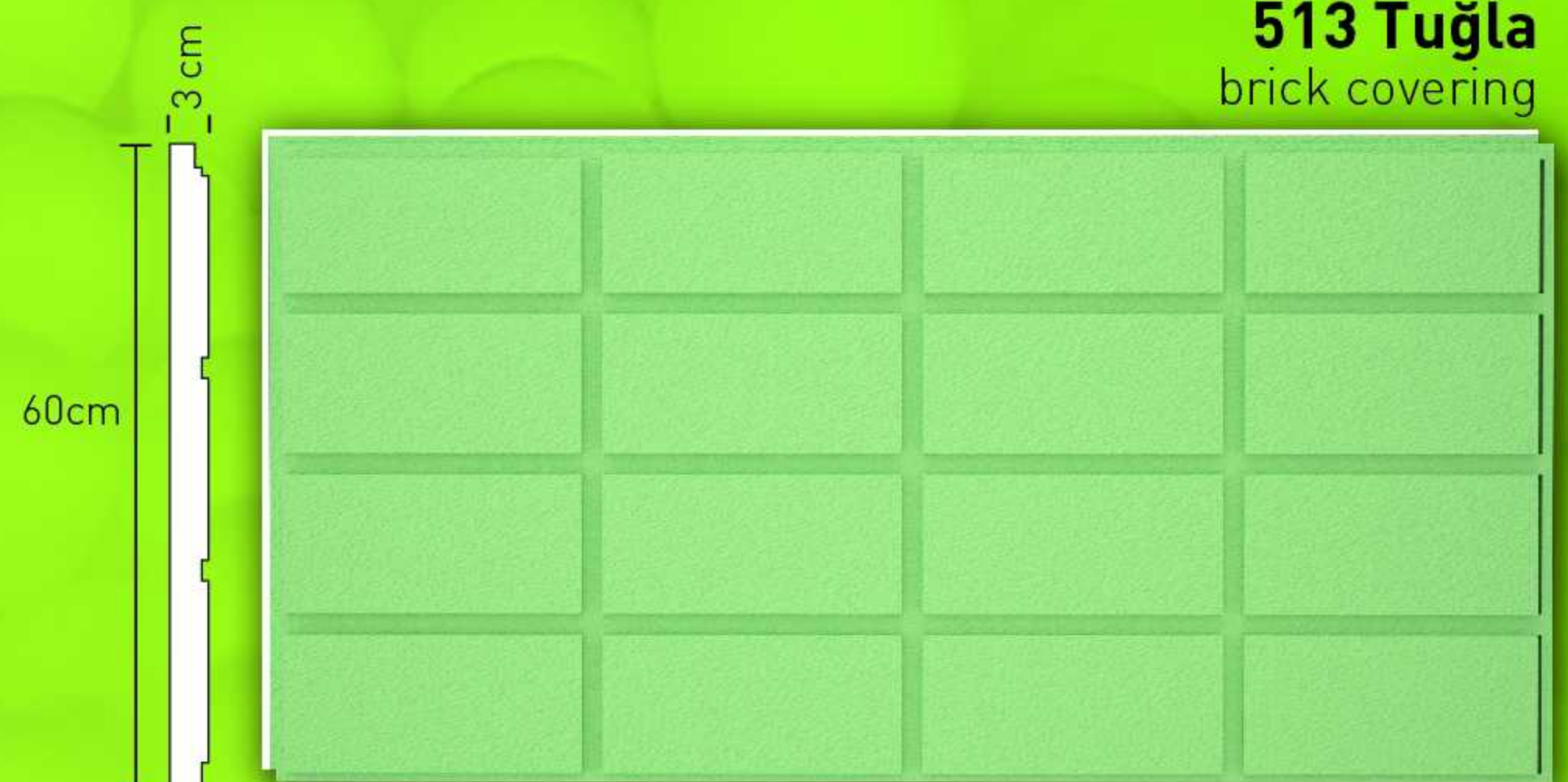

513 Tuğla
brick covering

120 cm

120 cm

BİTİŞ PROFİLLERİ

Finish Profiles

TEKLİ KÖŞE TAŞLARI

Single corner stone

506 Köşe Taşı / Corner Stone

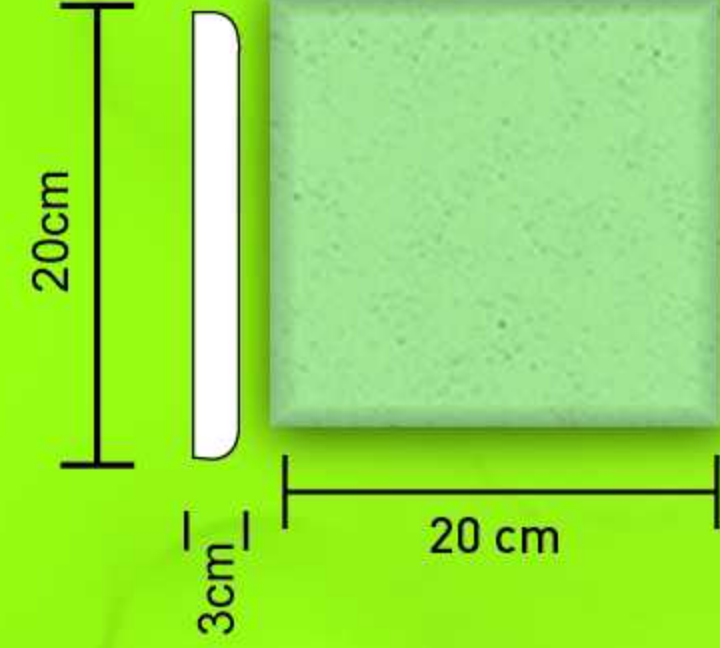
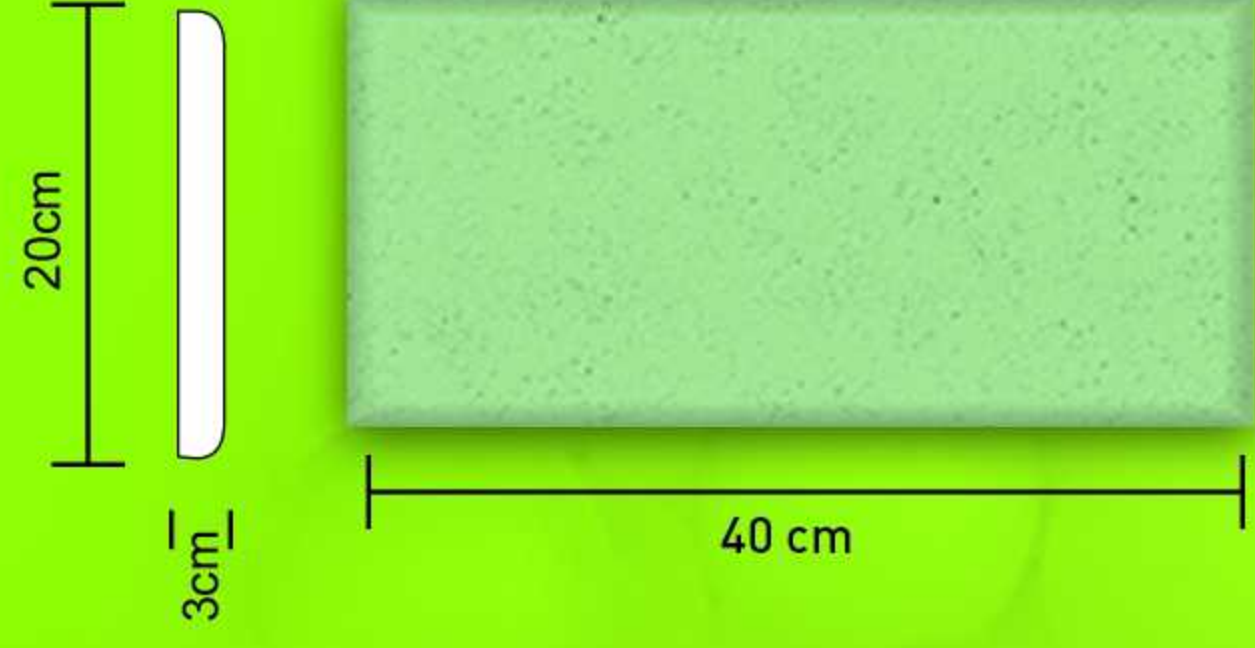

508 Köşe Taşı Desenli / Figured Corner Stone

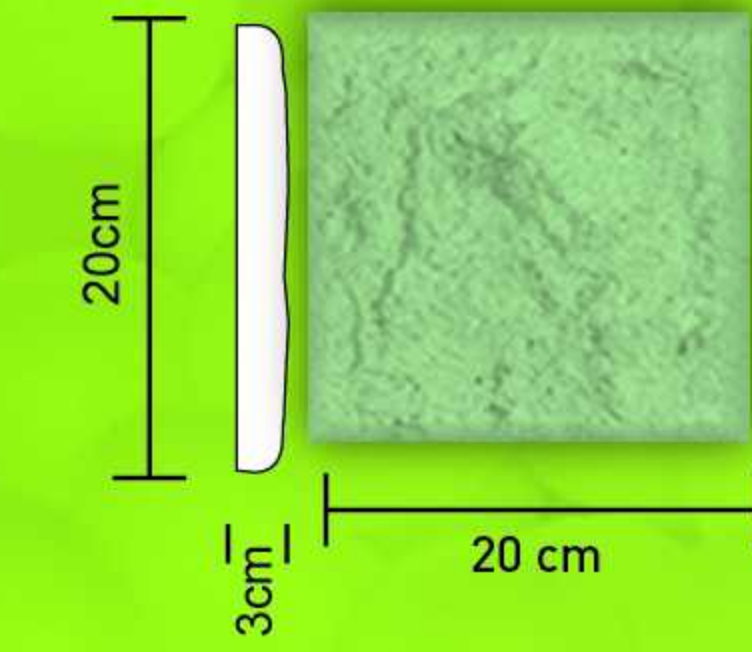
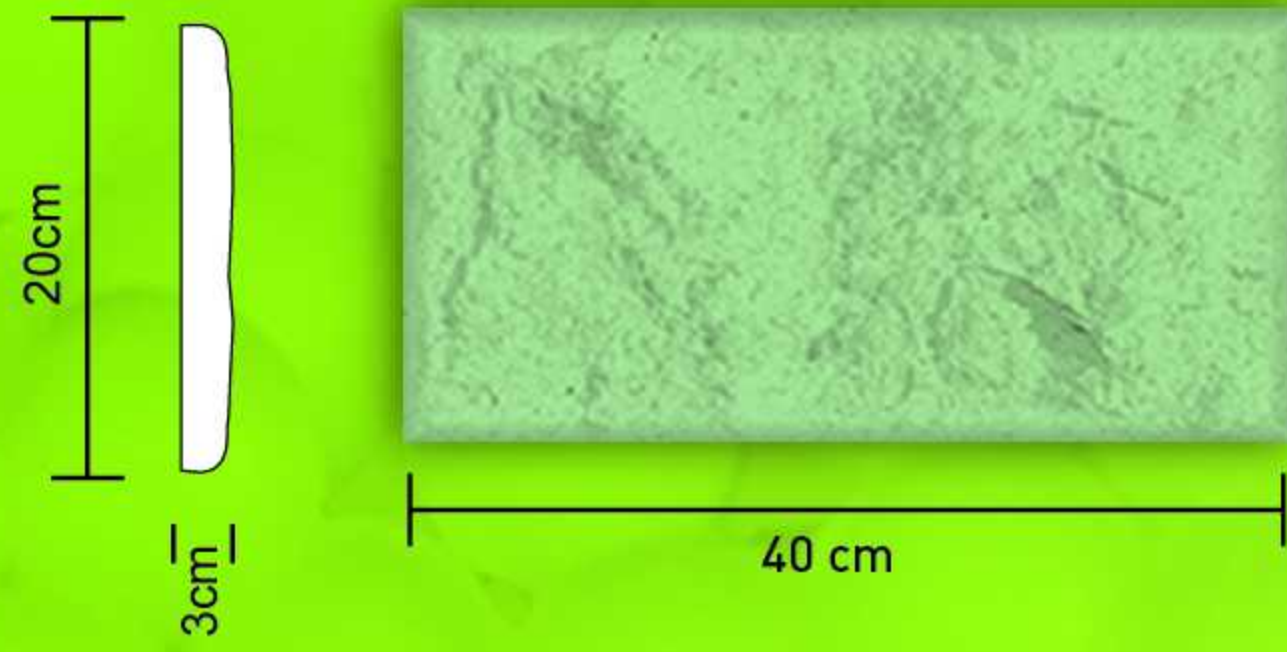

L TİPİ KÖŞE TAŞLARI

L-type corner stones

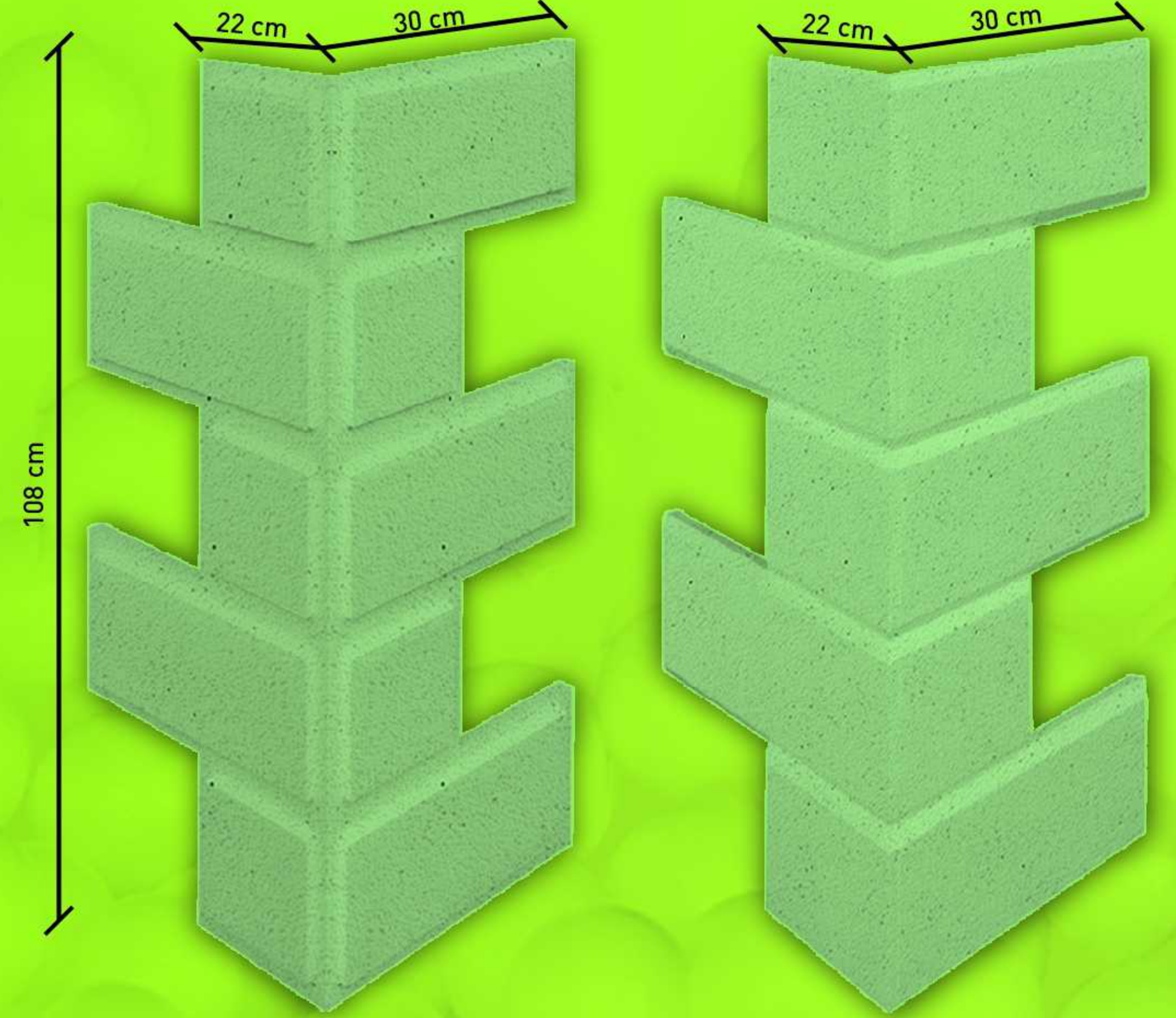

YB-06

YB-07



“hayatı güzelleştiren detaylar”

‘details beautify the life’

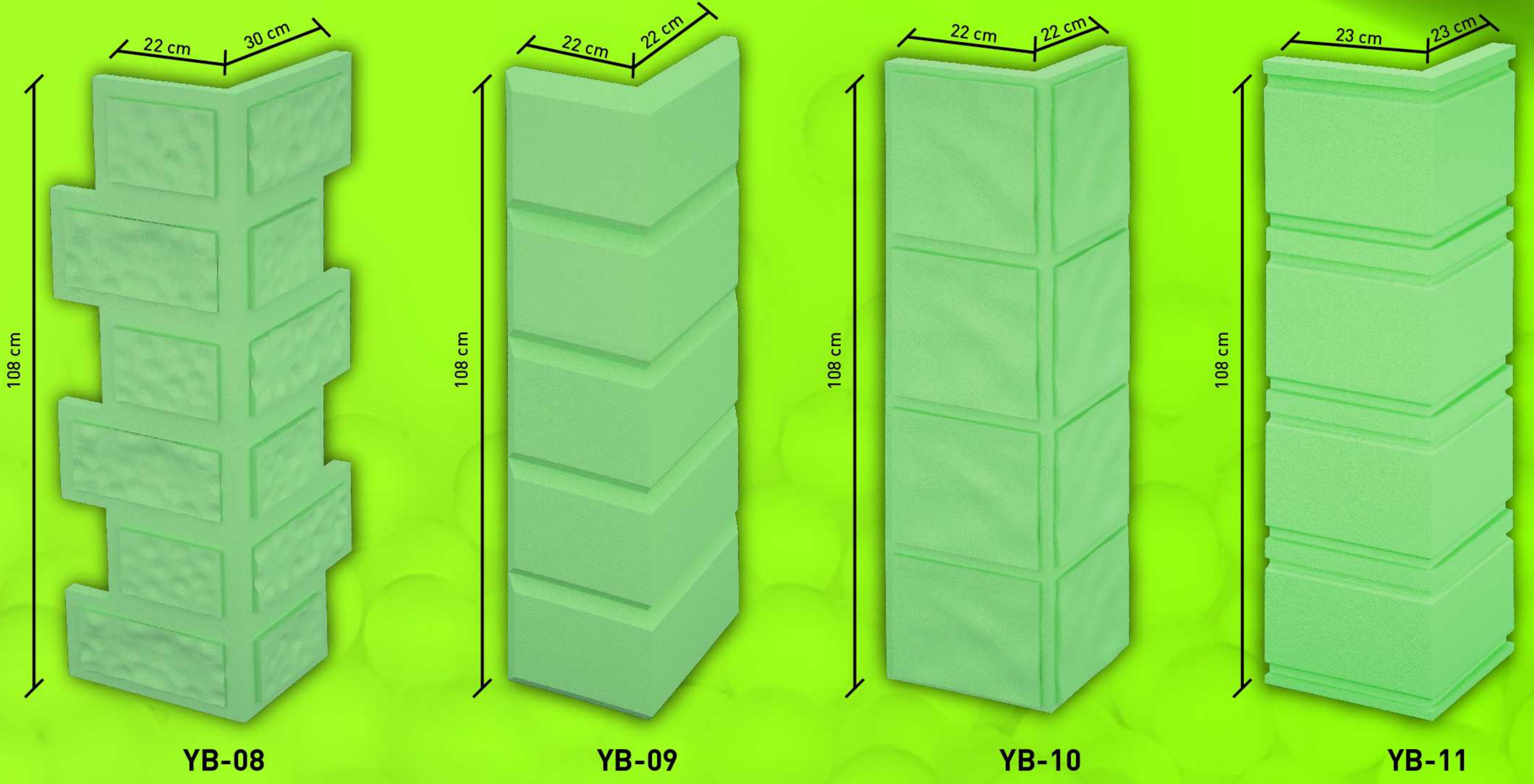

PALTOLAMA FUGA PROFİLLERİ Jacketing joint gap profiles

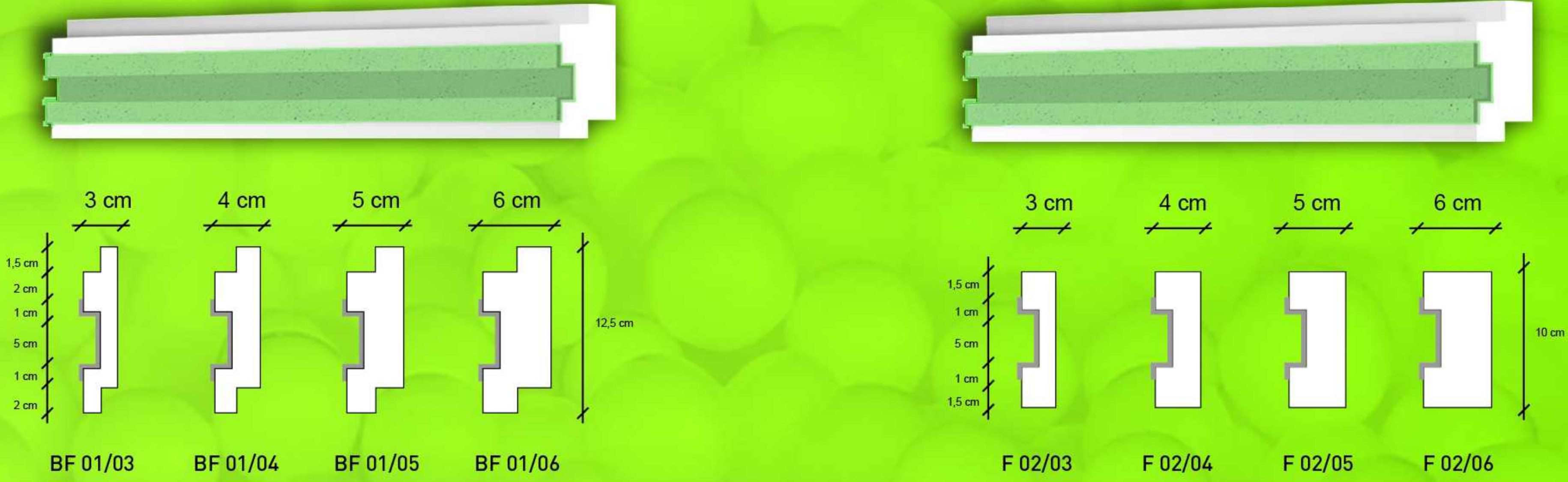

BORU KAPLAMA PROFİLLERİ

Pipe covering profiles

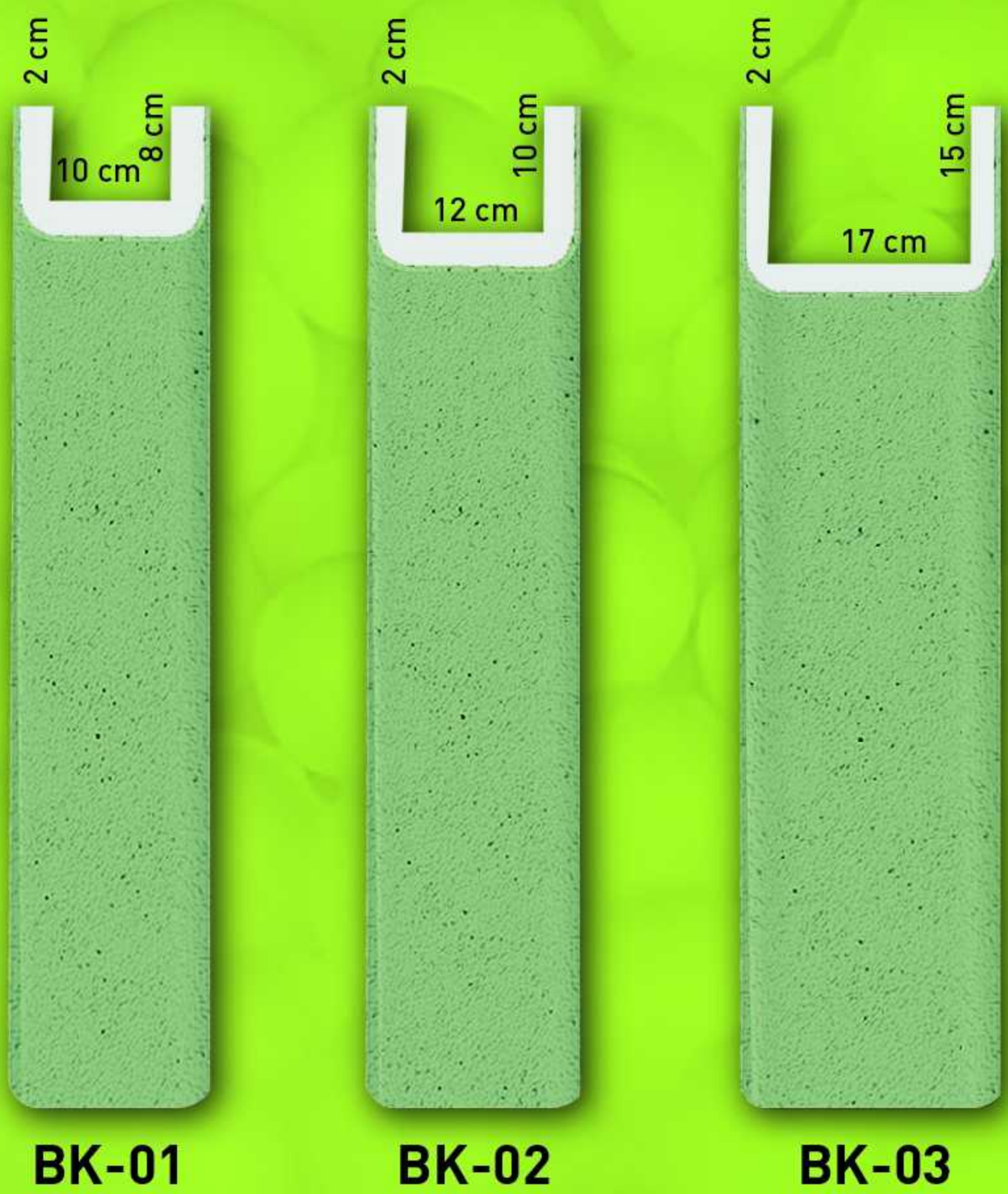

DİP VE DİK KÖŞE PROFİLLERİ

Edge and upright corner profiles

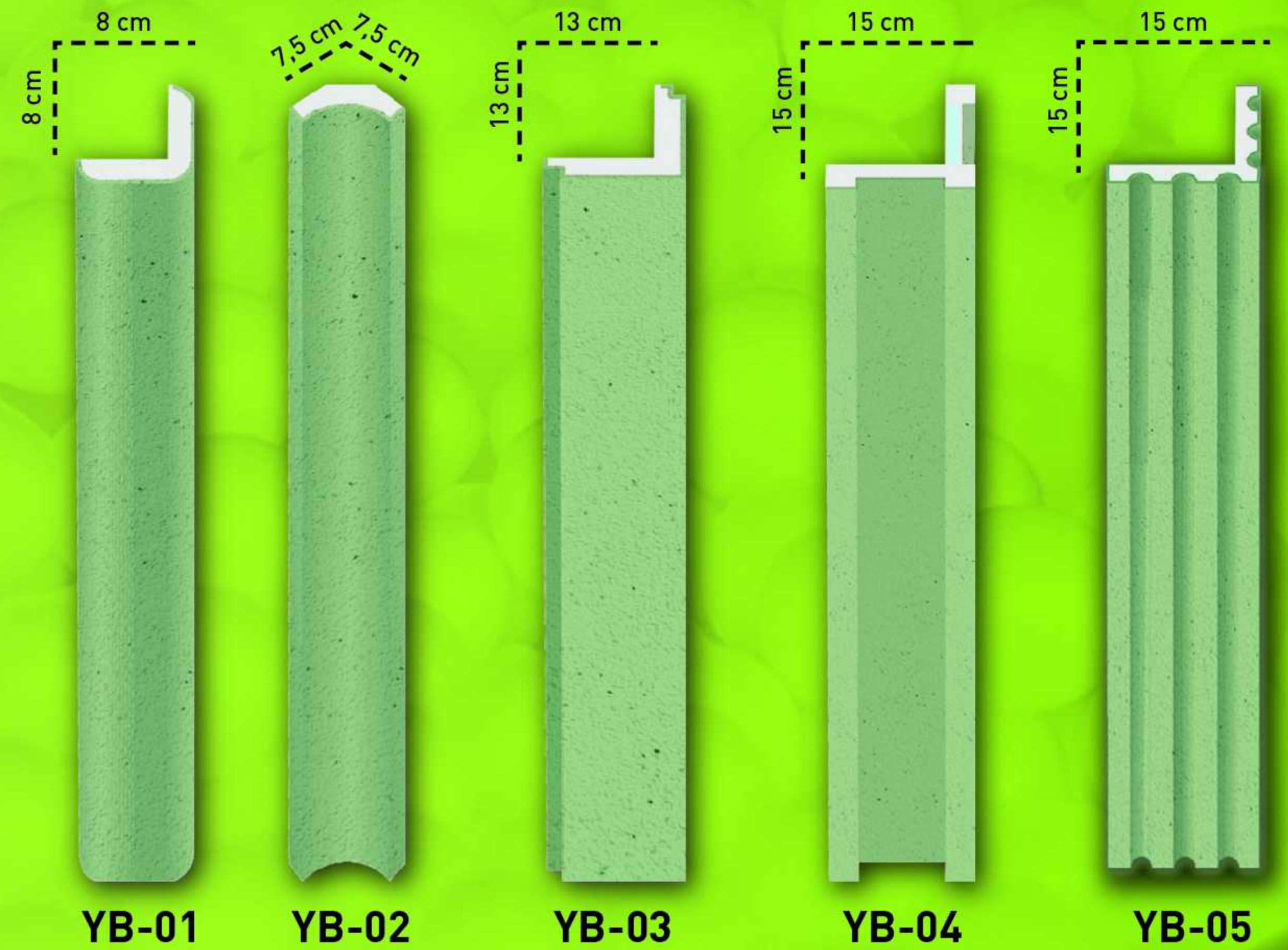

DIŞ CEPHE DEKOR PROFİLLERİ

Exterior Decoration Profiles

3cm	DIŞ 104
9cm	
1,5cm	DIŞ 105
3,5cm	
10cm	
2cm	DIŞ 106
4cm	
10cm	
2cm	DIŞ 107
2,5cm	
10cm	
1cm	DIŞ 108
4cm	
10cm	
3cm	DIŞ 109
5cm	
10cm	
3cm	DIŞ 110
4cm	
12cm	
1,5cm	DIŞ 113
5,5cm	
11,5cm	
1cm	DIŞ 114
2,5cm	
11,5cm	
1,5cm	DIŞ 115
4cm	
12cm	
1,5cm	DIŞ 116
4cm	
12,5cm	
2cm	DIŞ 117
6cm	
12cm	
3cm	DIŞ 079
7cm	
14cm	
2,5cm	DIŞ 121
4cm	
15cm	
3cm	

Standart boylar 200 cm 'dir - The standard length is 200 cm

“hayatı güzelleştiren detaylar”

'details beautify the life'

DIŞ 153

15cm

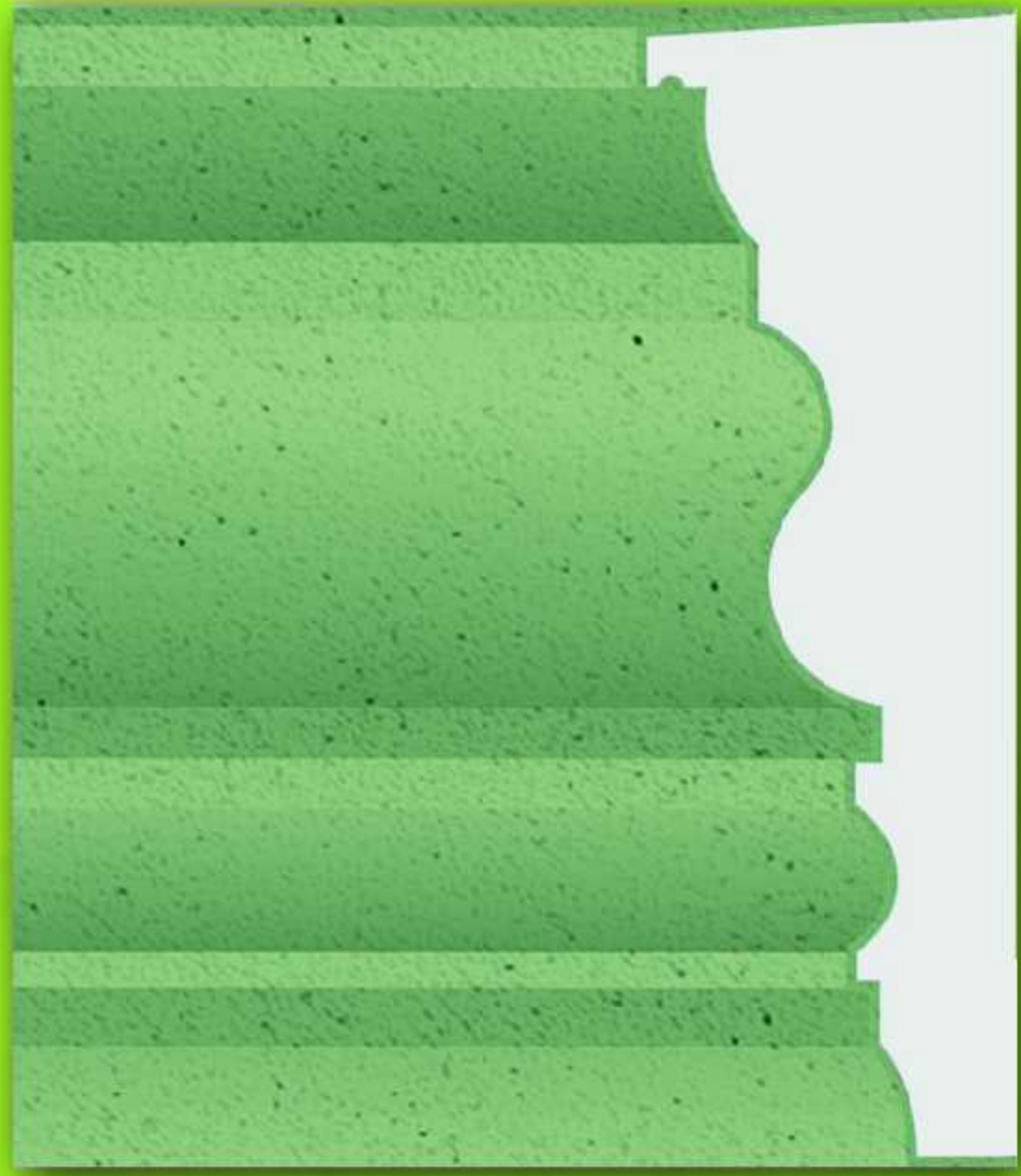

50cm

4cm

DIŞ 154

9,5cm



25cm

4cm

DIŞ 138

7,5cm



25cm

1cm

DIŞ 136

4,5cm



20cm

2cm

DIŞ 132

4cm



20cm

1,5cm

DIŞ 154

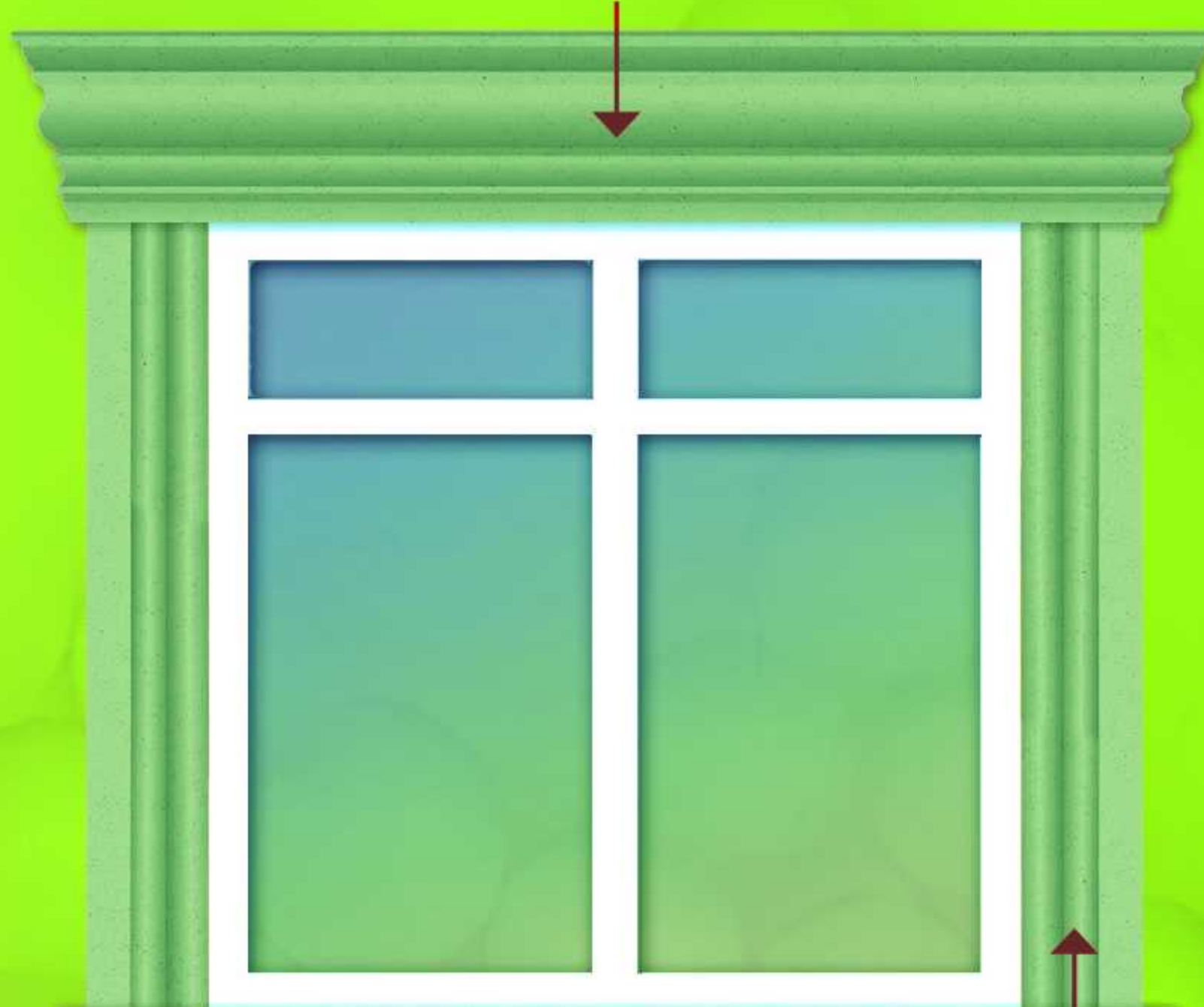

DIŞ 091

DIŞ 131

DIŞ 116

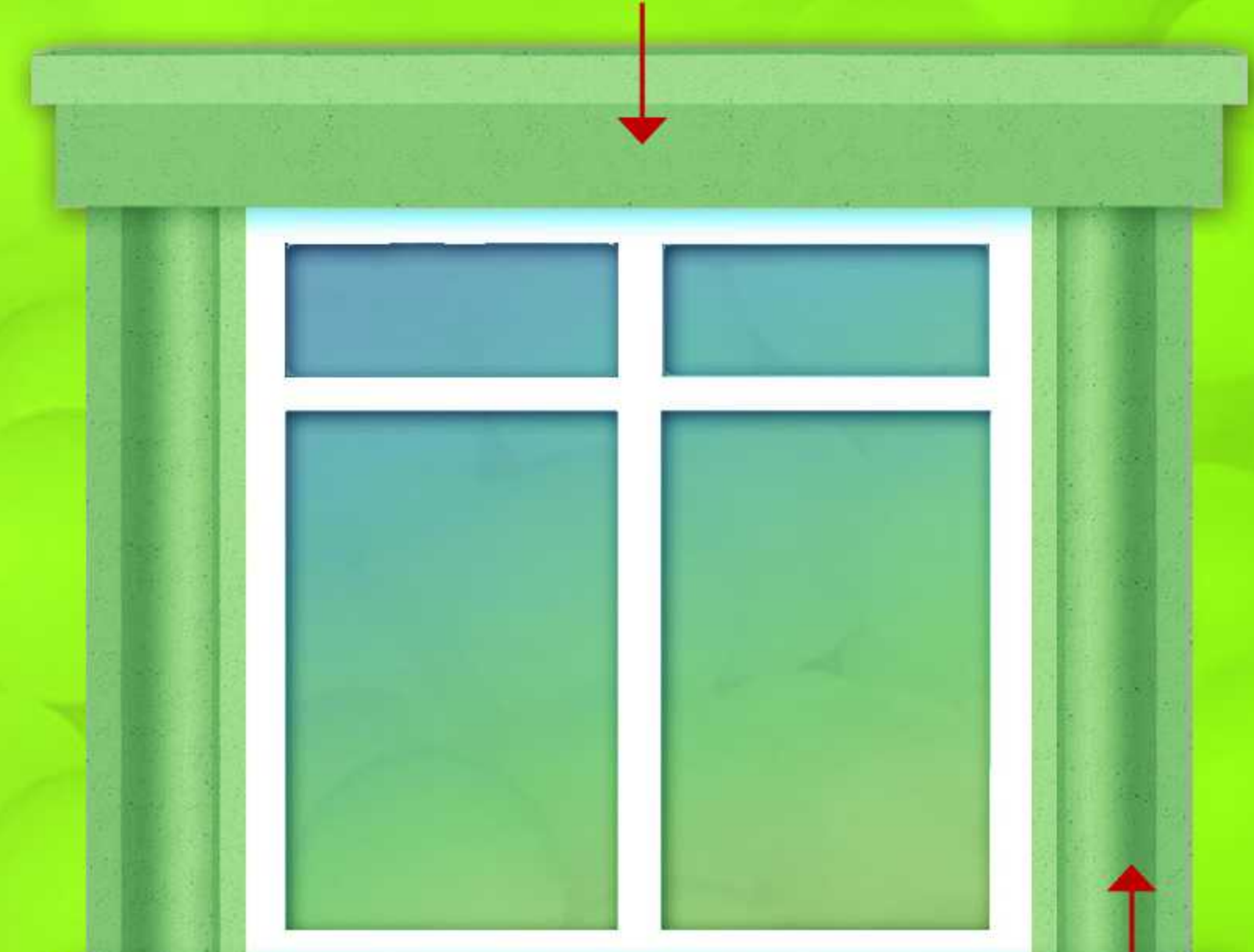

DIŞ 082

DIŞ 136



DIŞ 082

7 cm

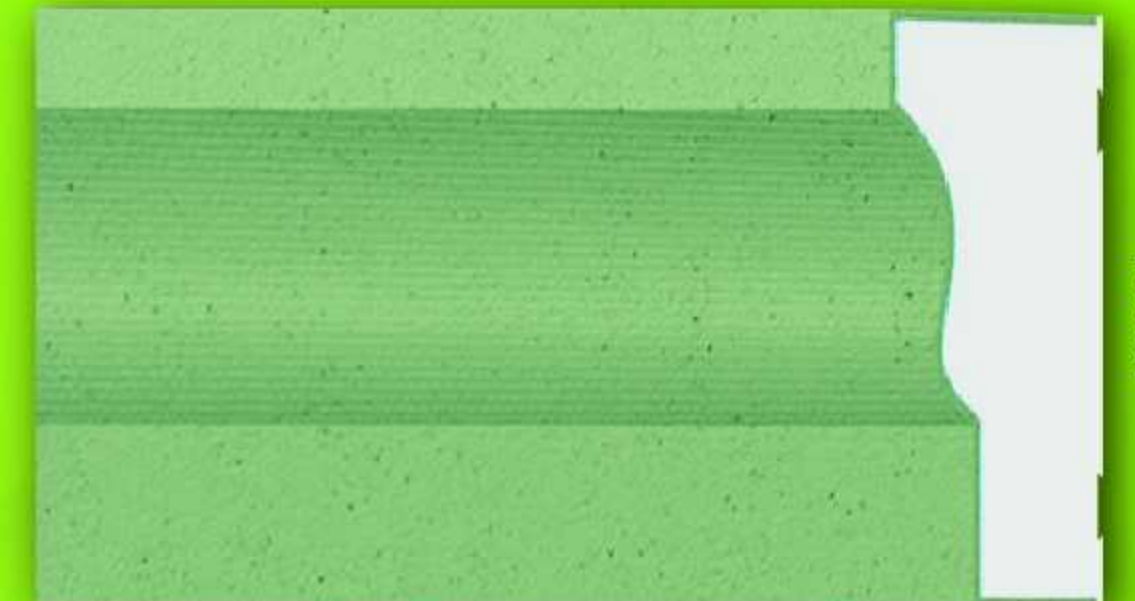

15cm

4,5cm

DIŞ 083

9 cm



16,5cm

4cm

DIŞ 088

8,5 cm



20cm

4,5cm

DIŞ 091

7,5cm



20,5cm

3cm

DIŞ 130

8cm



18,5cm

4,5cm

DIŞ 131

9cm

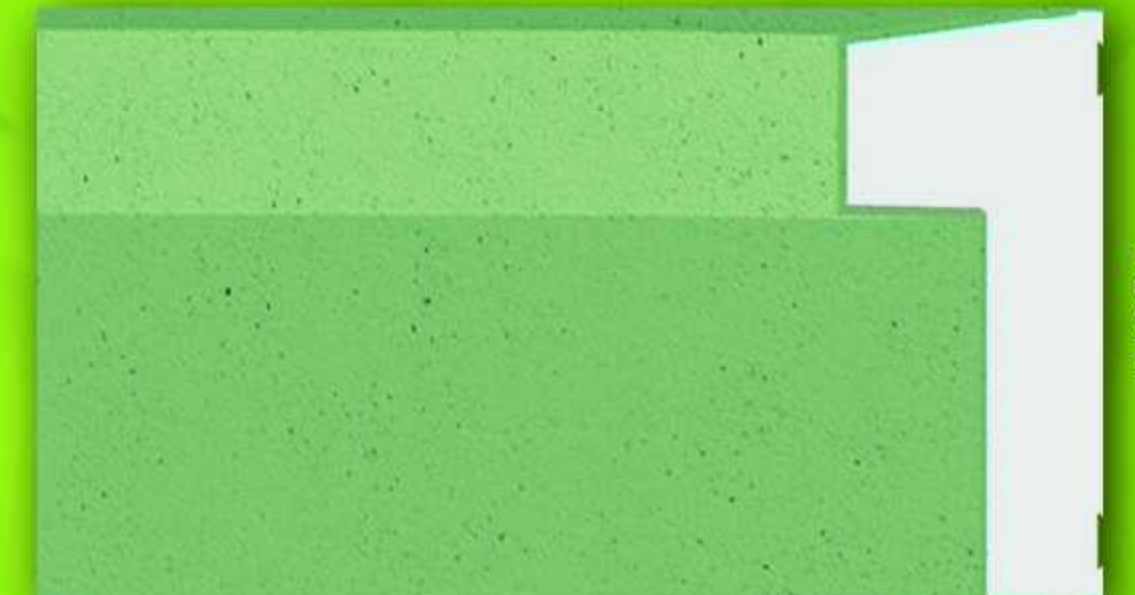

20cm

5cm

Standart boylar 200 cm 'dir - The standard length is 200 cm



DIŞ DEKOR PROFİLLERİ

Exterior Decoration Profiles

DIŞ 151

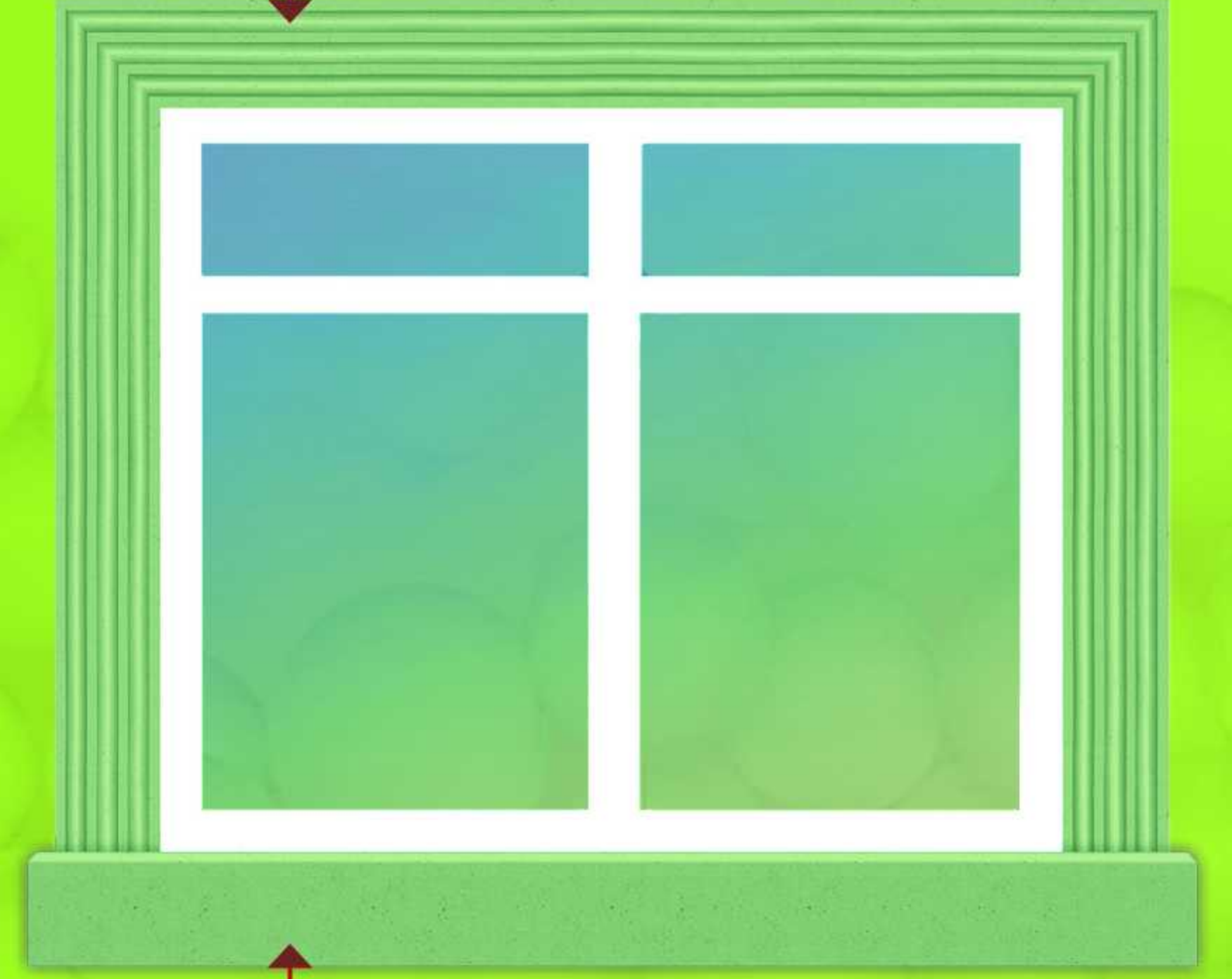

DIŞ 092



DIŞ 122



DIŞ 152



DIŞ 129

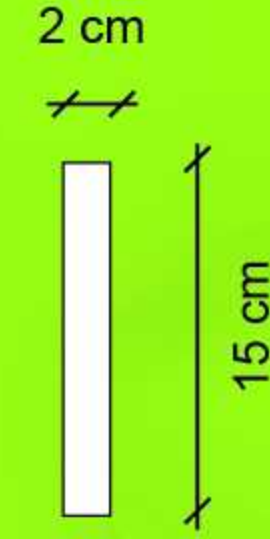

DIŞ 147

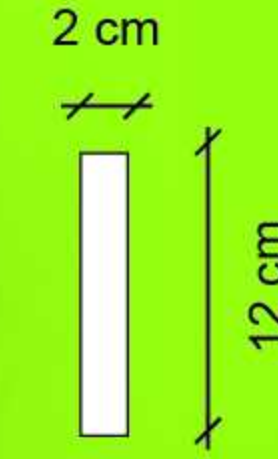

DIŞ 119

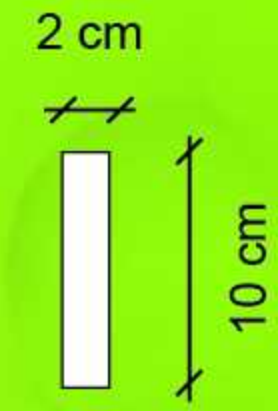

DIŞ 146

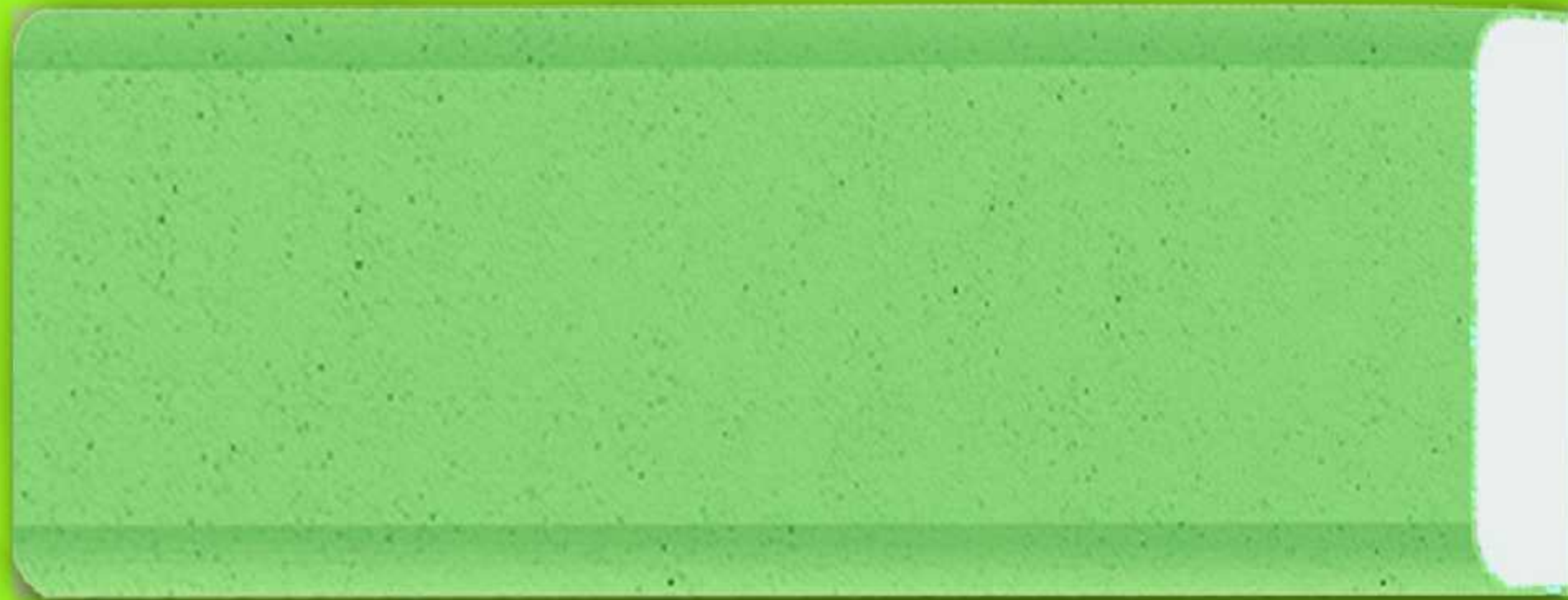

DIŞ 148

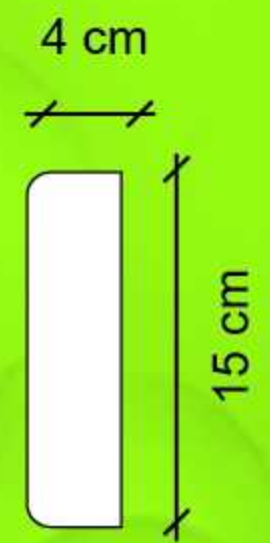

DIŞ 149

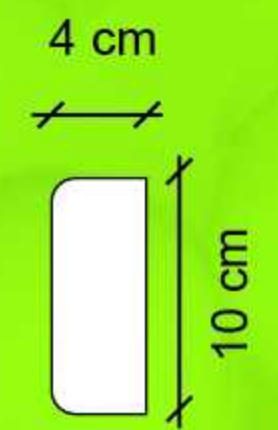

DIŞ 150

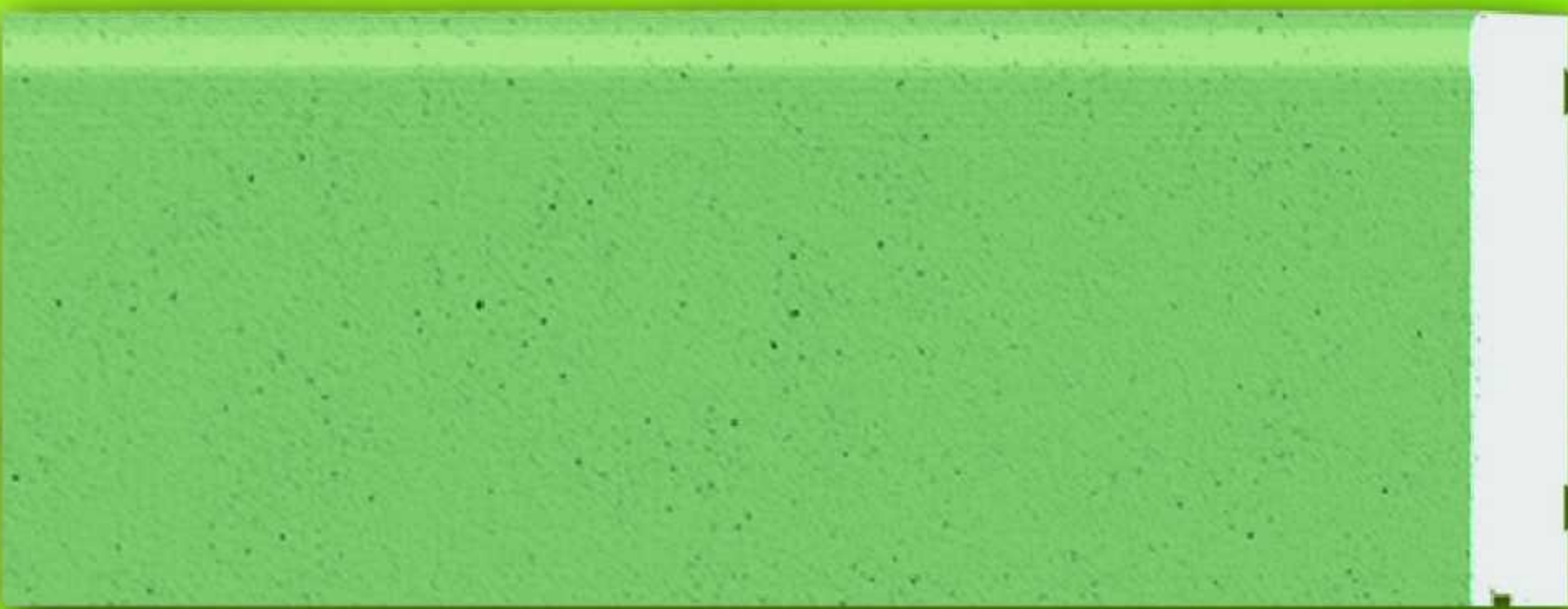

DIŞ 092

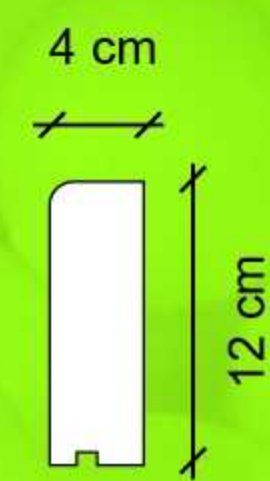

DIŞ 077



DIŞ 137



DIŞ 151

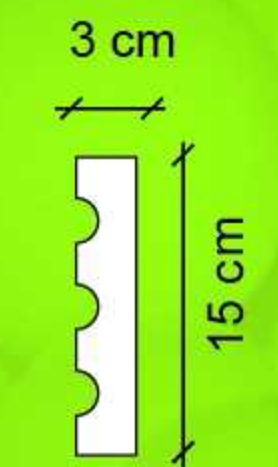

DIŞ 123

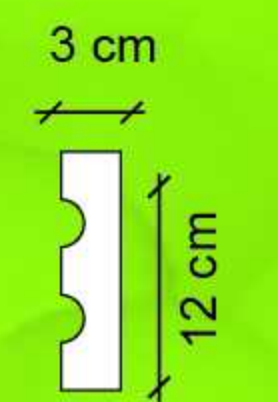

DIŞ 112

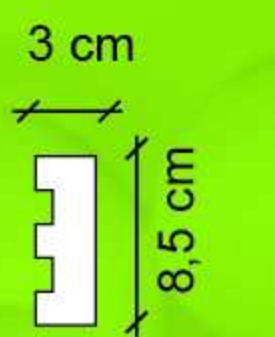

DIŞ 102



DIŞ 152



DIŞ 122

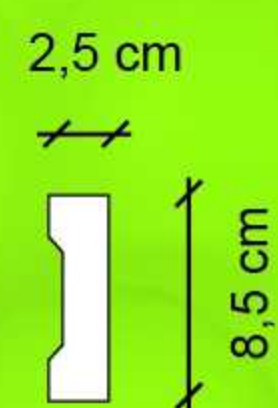

DIŞ 101



DIŞ 125

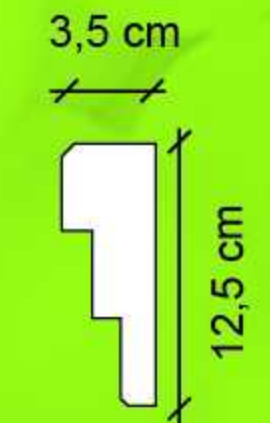

DIŞ 120

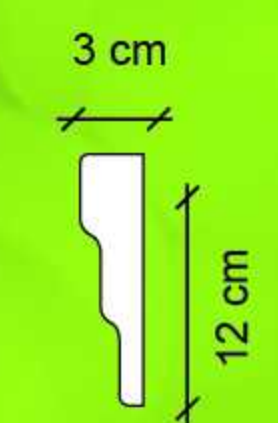

DIŞ 111

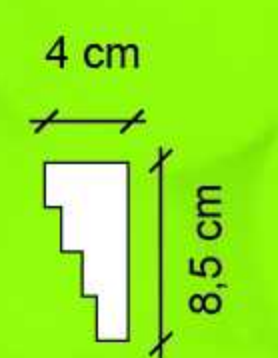

DIŞ 103



DAMLALIKLI DIŞ DEKOR PROFİLLERİ

Exterior Decoration Profiles With Dripstone

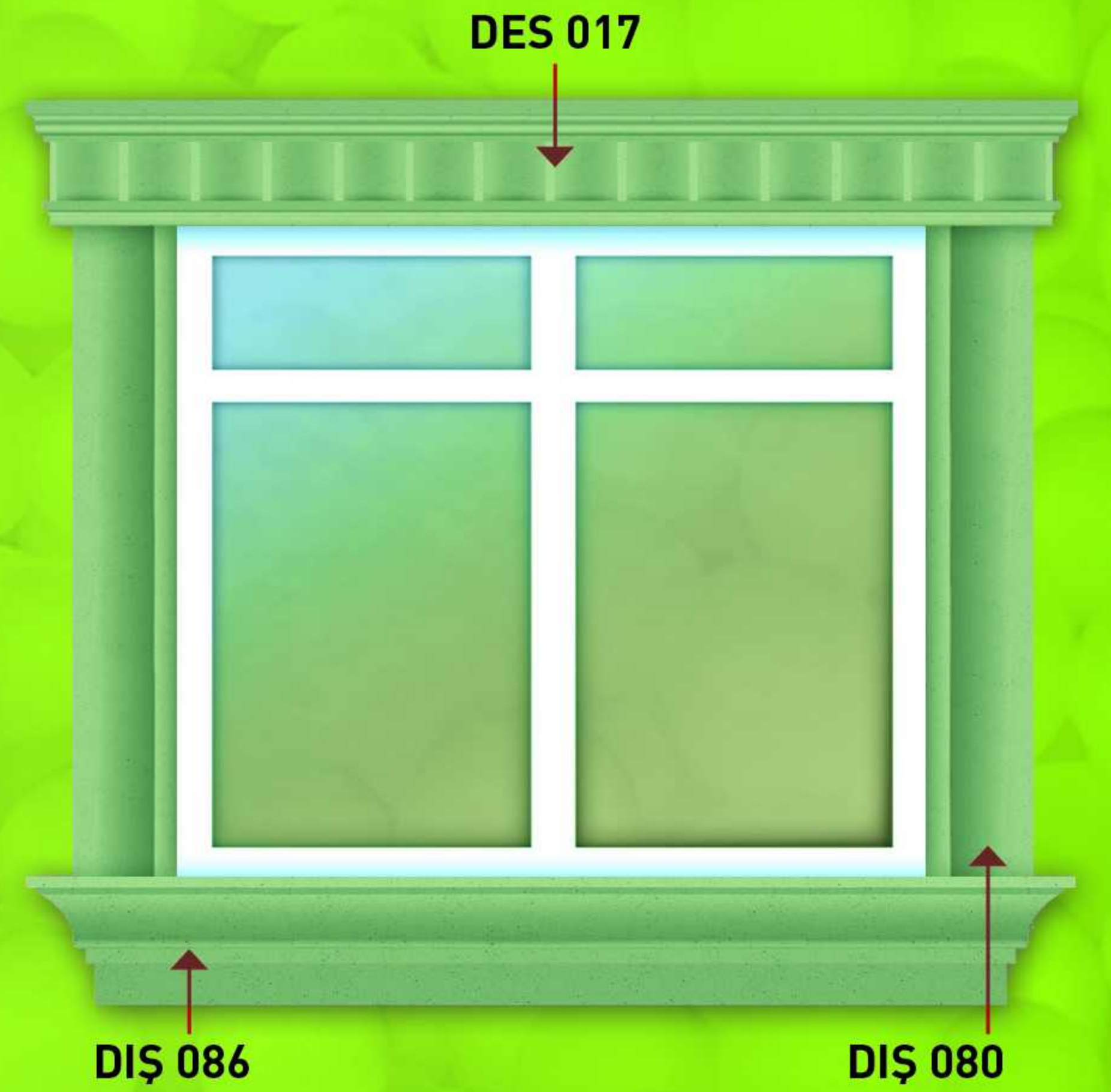
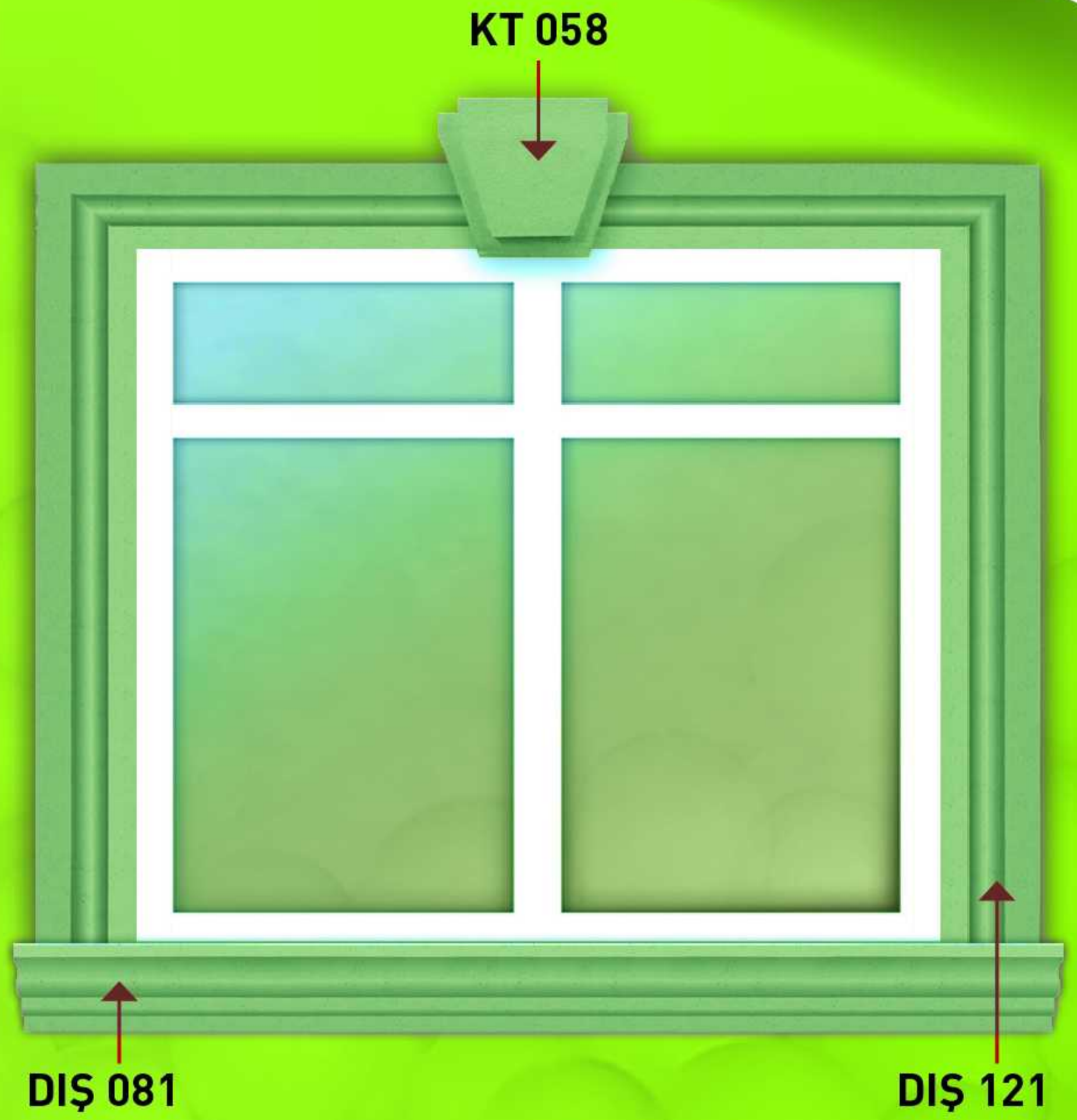
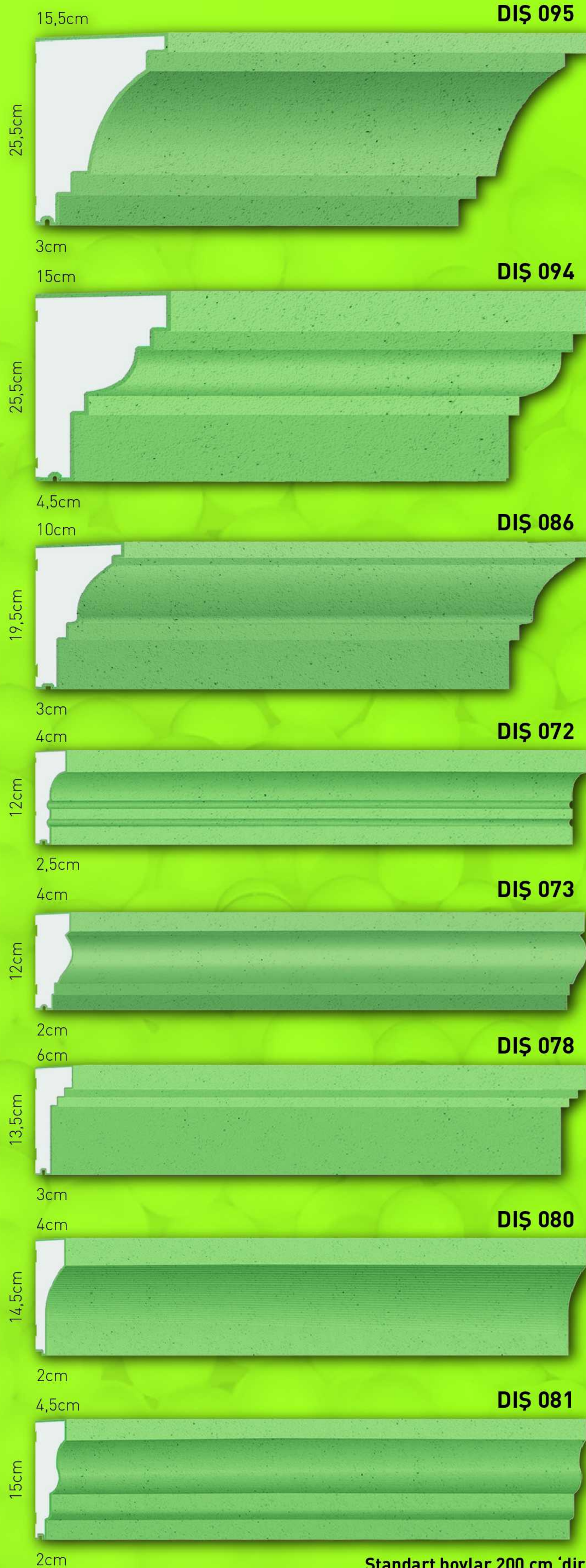

Standart boylar 200 cm 'dir - The standard length is 200 cm

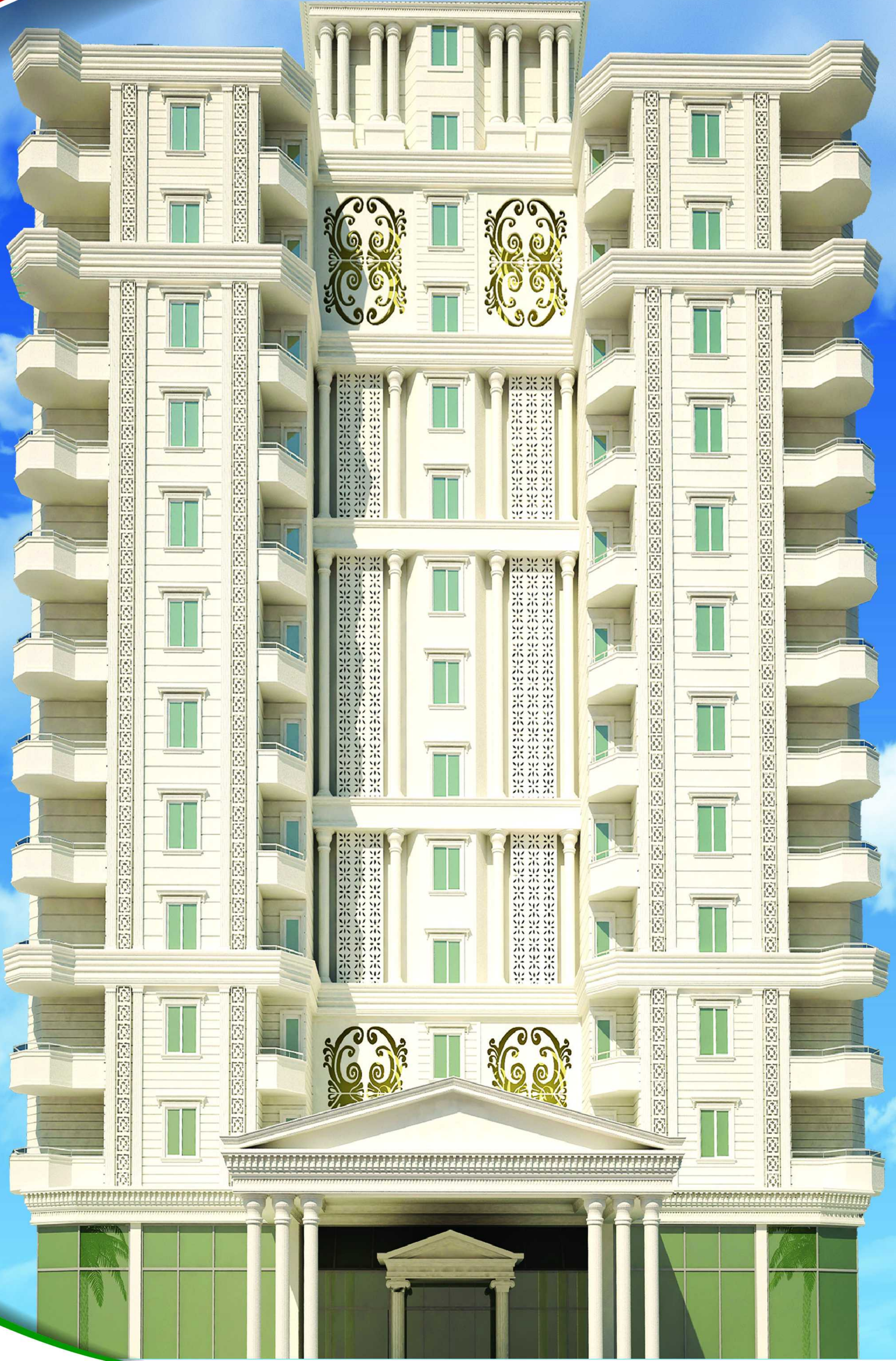

DESENLİ DIŞ CEPHE PROFİLLERİ

Figured Exterior Decoration Profiles

DES 01

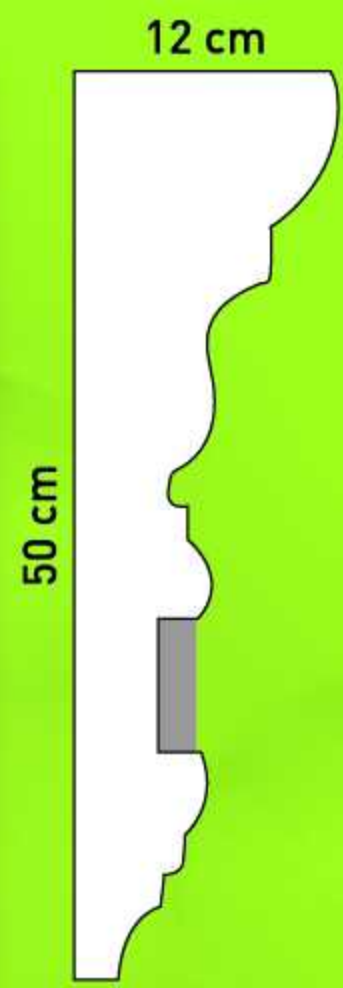
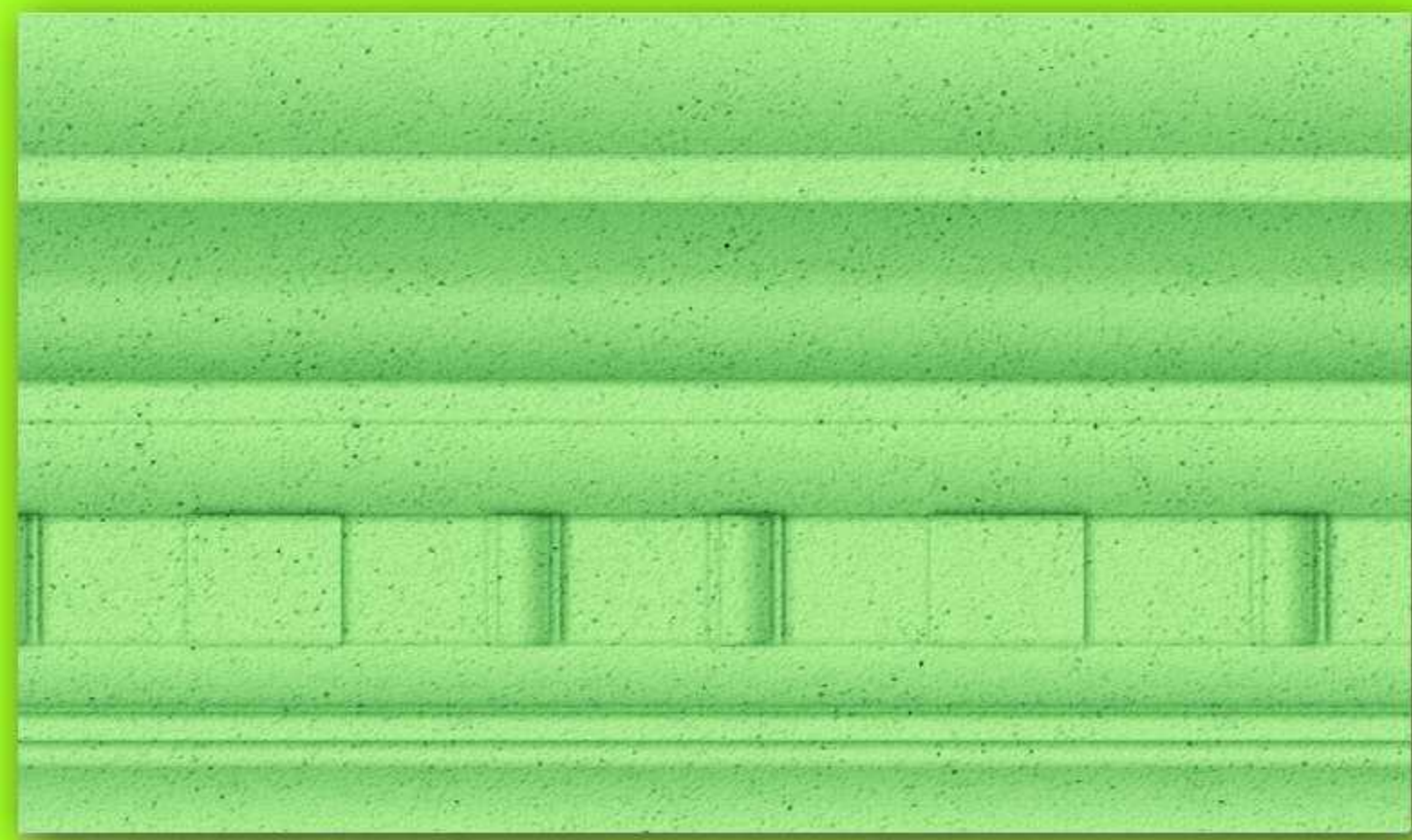

DES 06

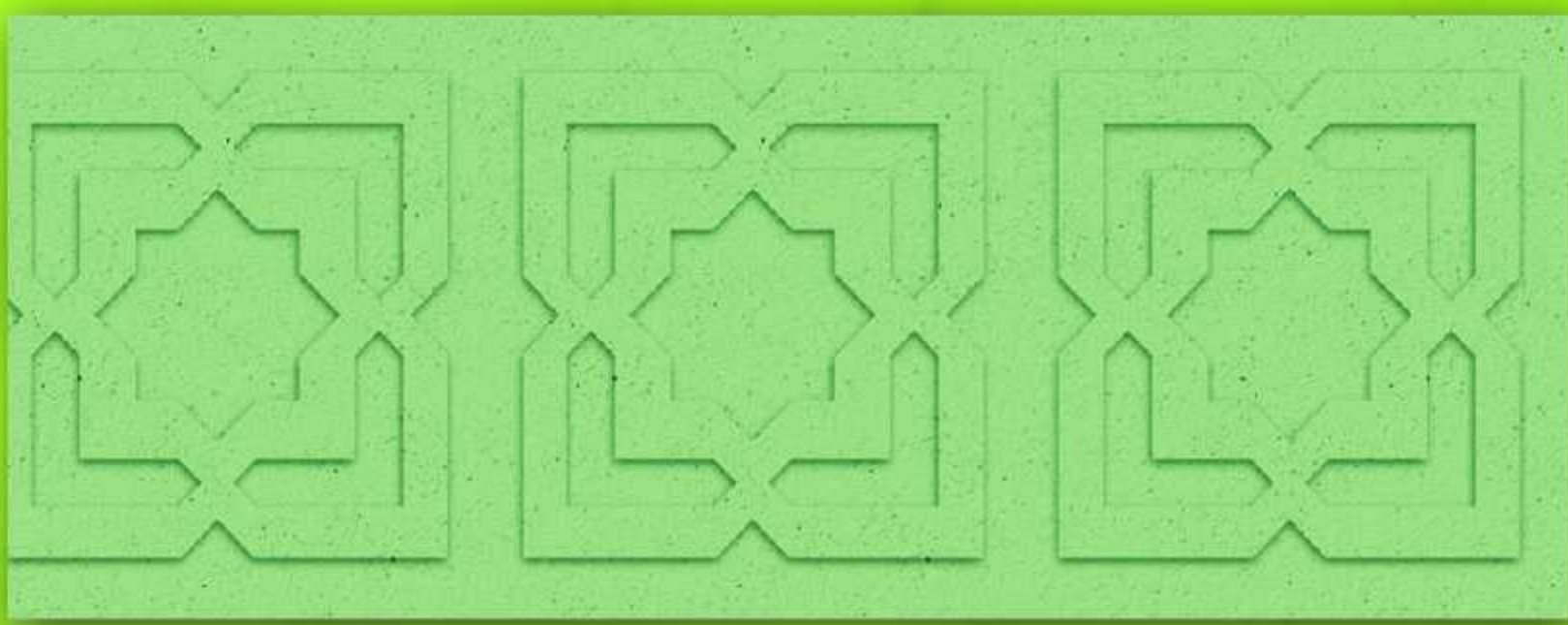

DES 18

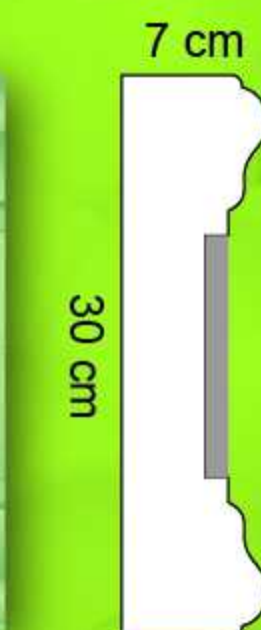

DES 04



DES 05



DES 13



DES 14

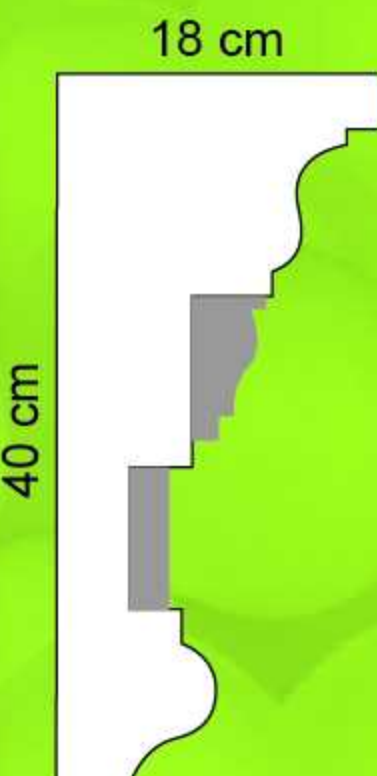
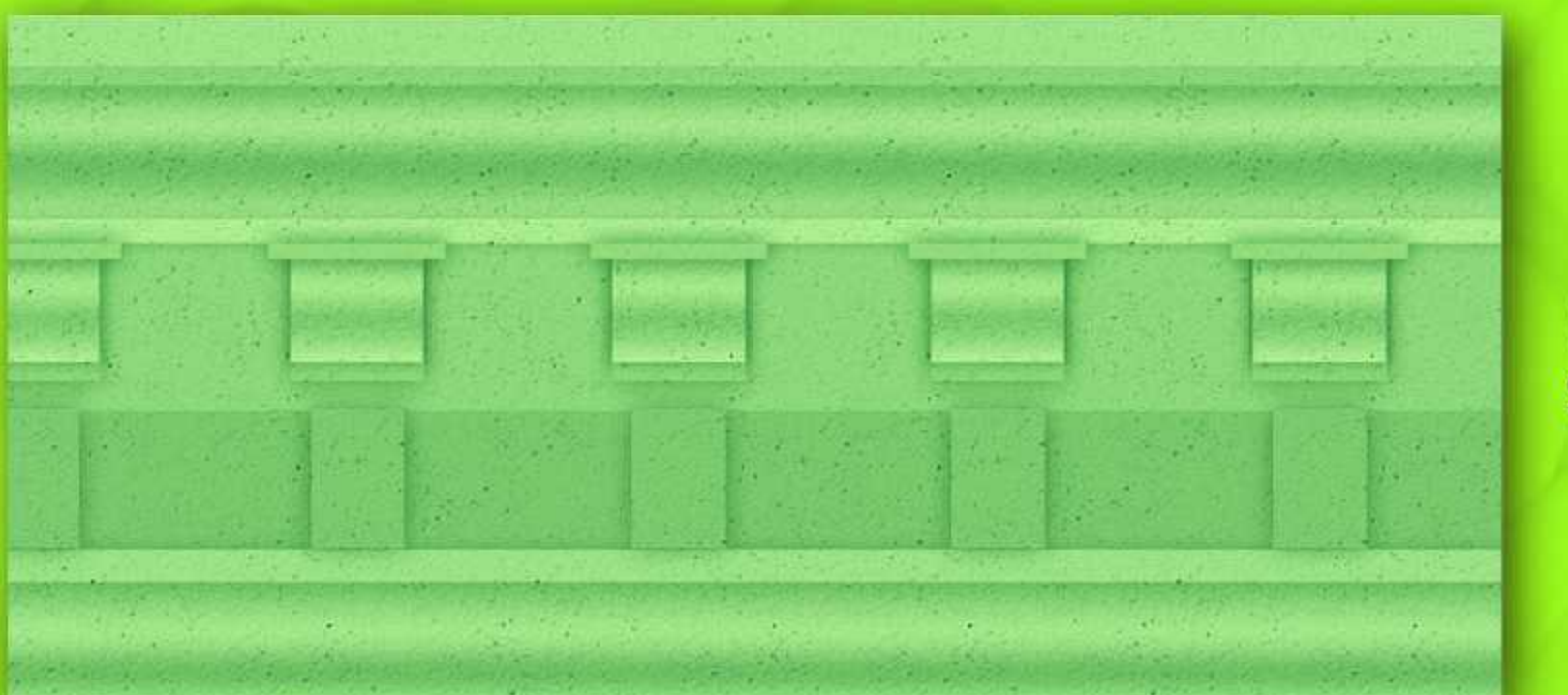

DES 02

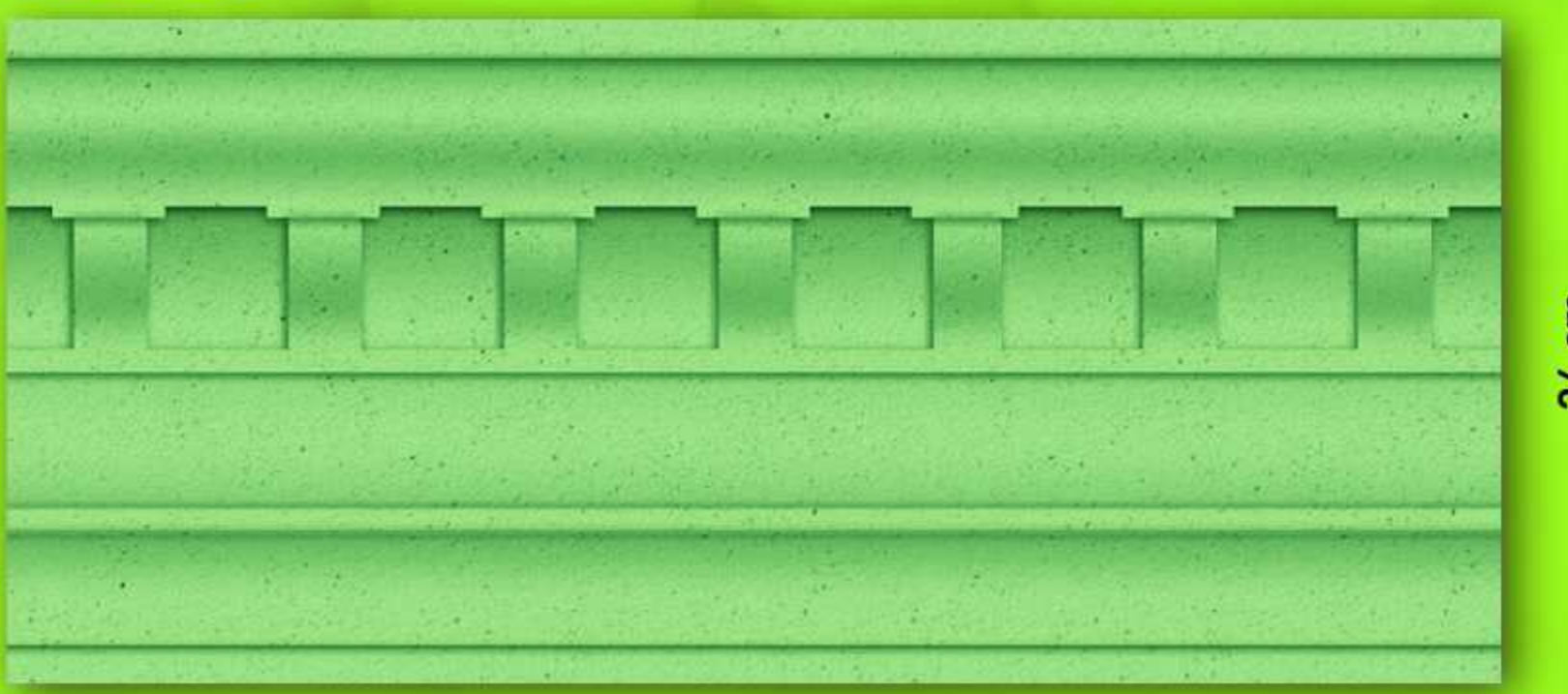

DES 03

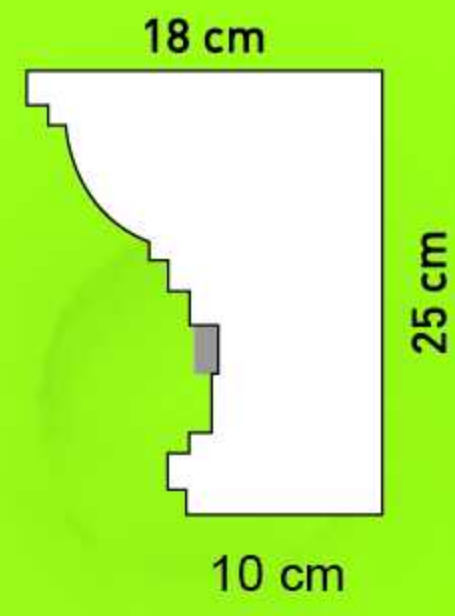

DES 15

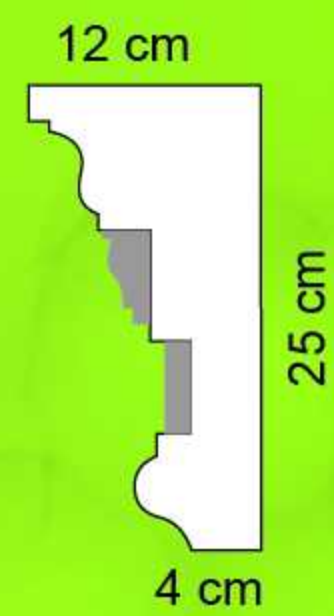

DES 16

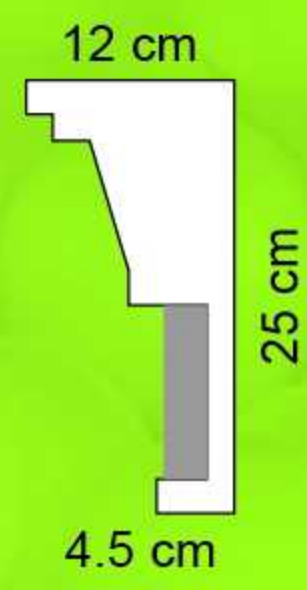

DES 08



DES 19

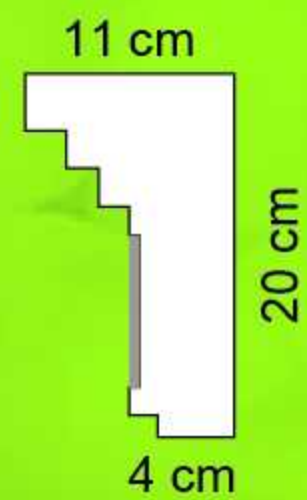

DES 09



DES 17

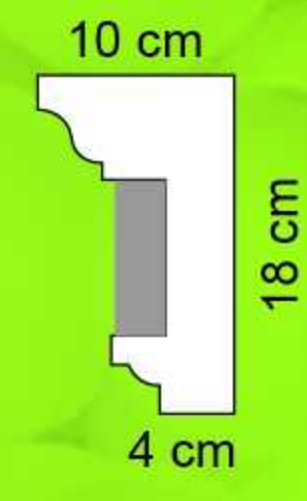
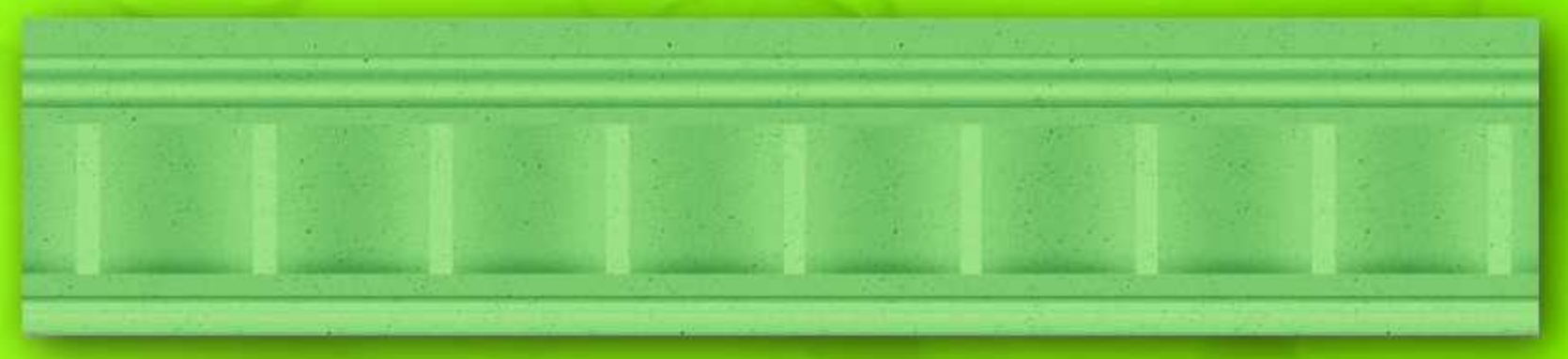

DES 10



DES 11

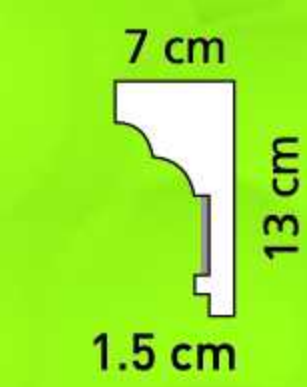
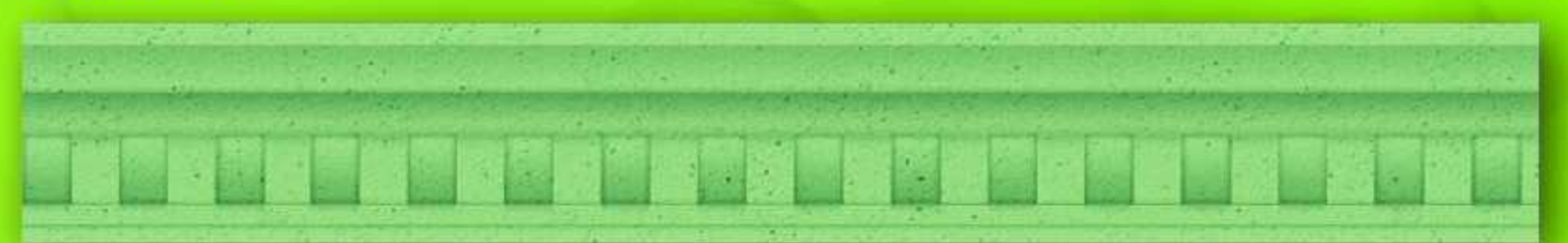

DES 12



Standart boylar 200 cm 'dir - The standard length is 200 cm

PENCERE DEKOR ÜRÜNLERİ

Window Decoration Products

KT 050



A: 20cm B: 20cm C: 13cm D: 5cm

KT 051



A: 25cm B: 20cm C: 14cm D: 5cm

KT 054/1



A: 20cm B: 20cm C: 20cm D: 4cm

KT 054/2



A: 15cm B: 15cm C: 15cm D: 4cm

KT 054/3



A: 12cm B: 12cm C: 12cm D: 4cm

KT 054/4



A: 8cm B: 8cm C: 8cm D: 2cm

KT 054/5



A: 4cm B: 4cm C: 4cm D: 1cm

KT 055



A: 20cm B: 20cm C: 13cm D: 5cm

KT 056



A: 21cm B: 20cm C: 12cm D: 5cm

KT 058

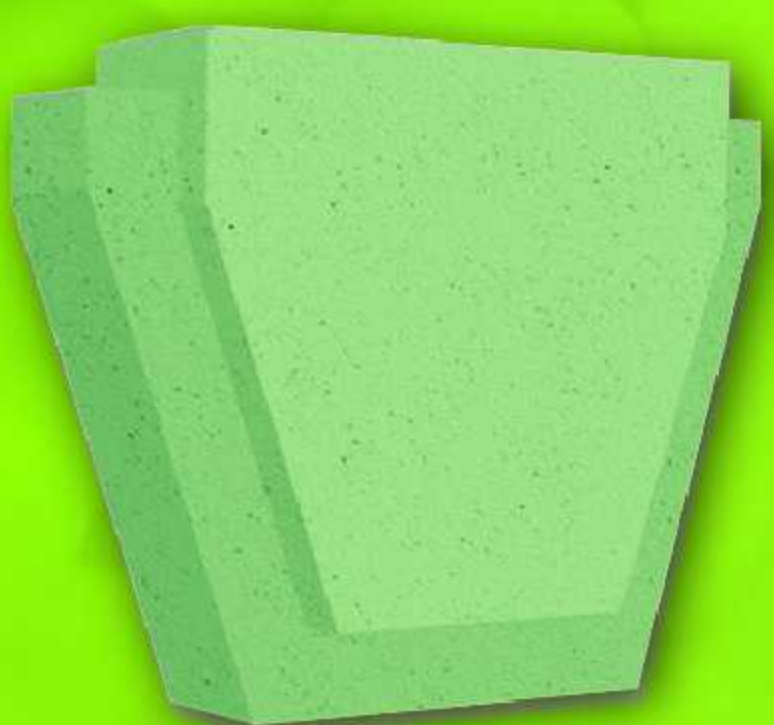

A: 26cm B: 21cm C: 15cm D: 6cm

KT 059



A: 25cm B: 25cm C: 18cm D: 5cm

KT 060

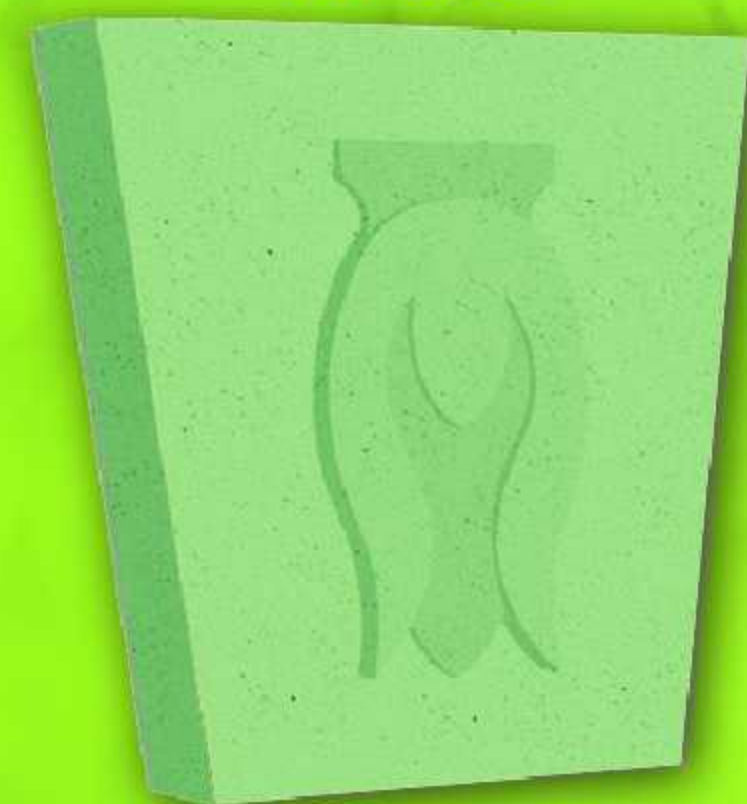

A: 25cm B: 25cm C: 18cm D: 5cm

KT 061



A: 16cm B: 22cm C: 10cm D: 5cm

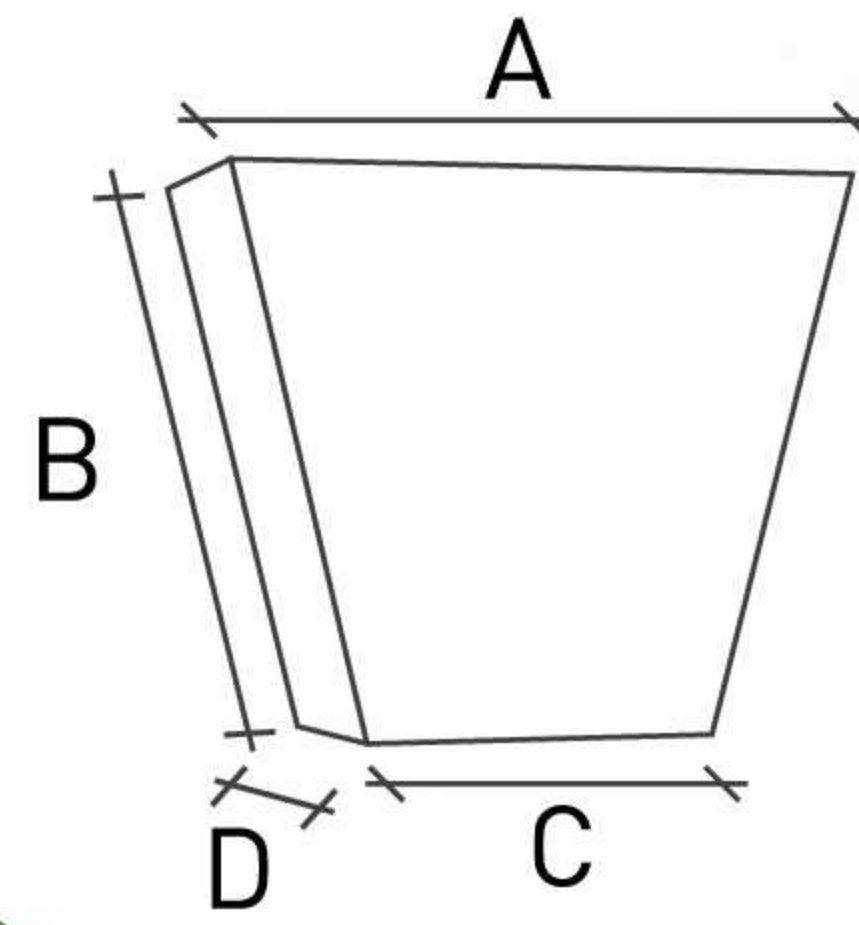
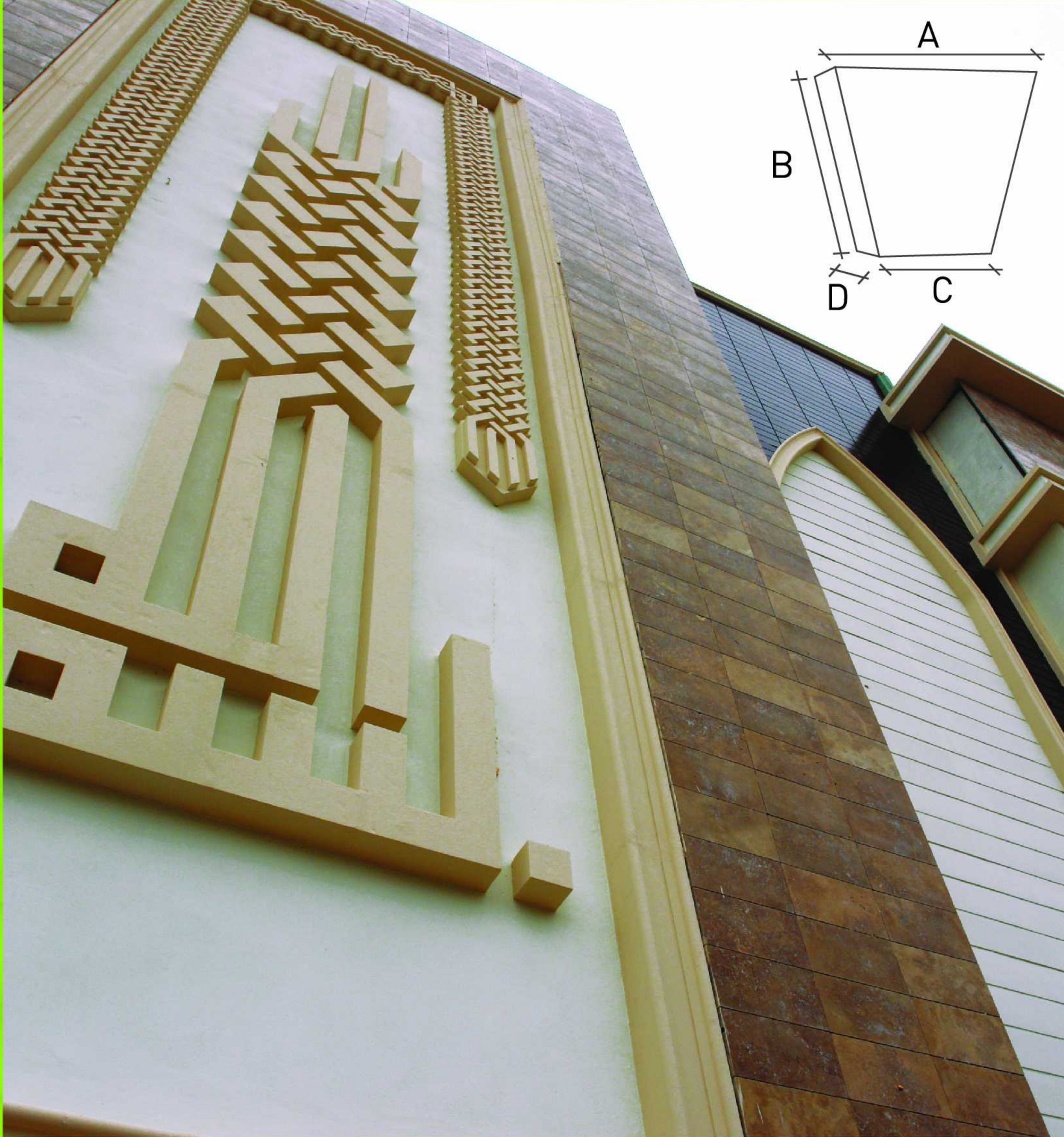

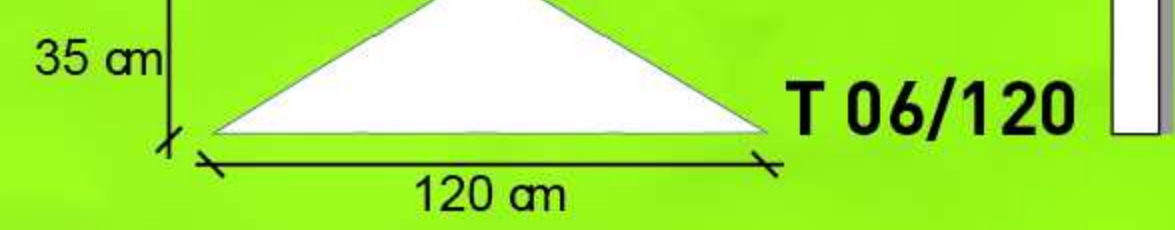
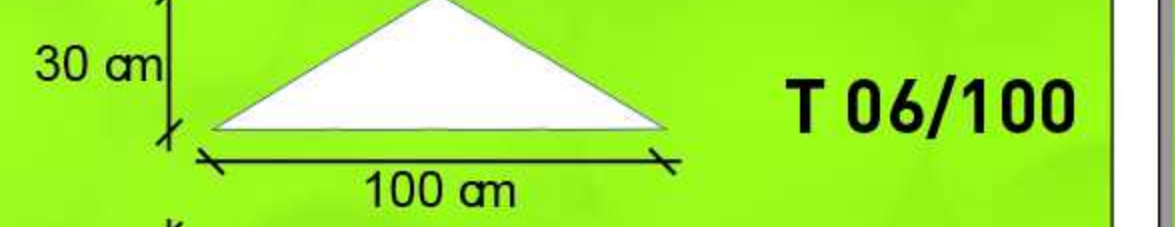
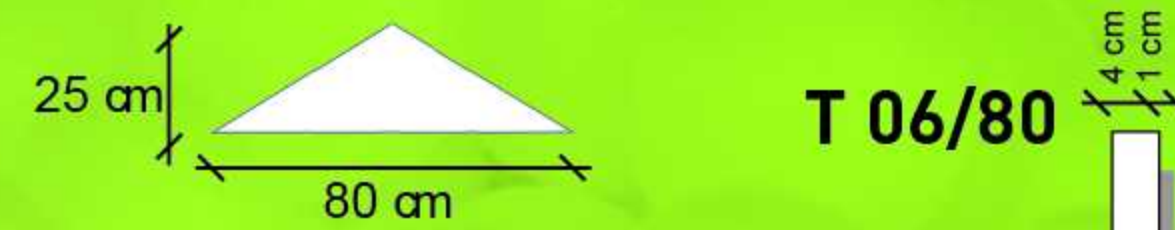
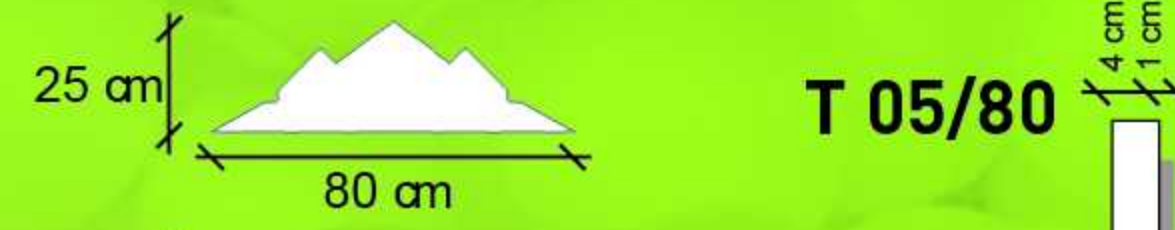
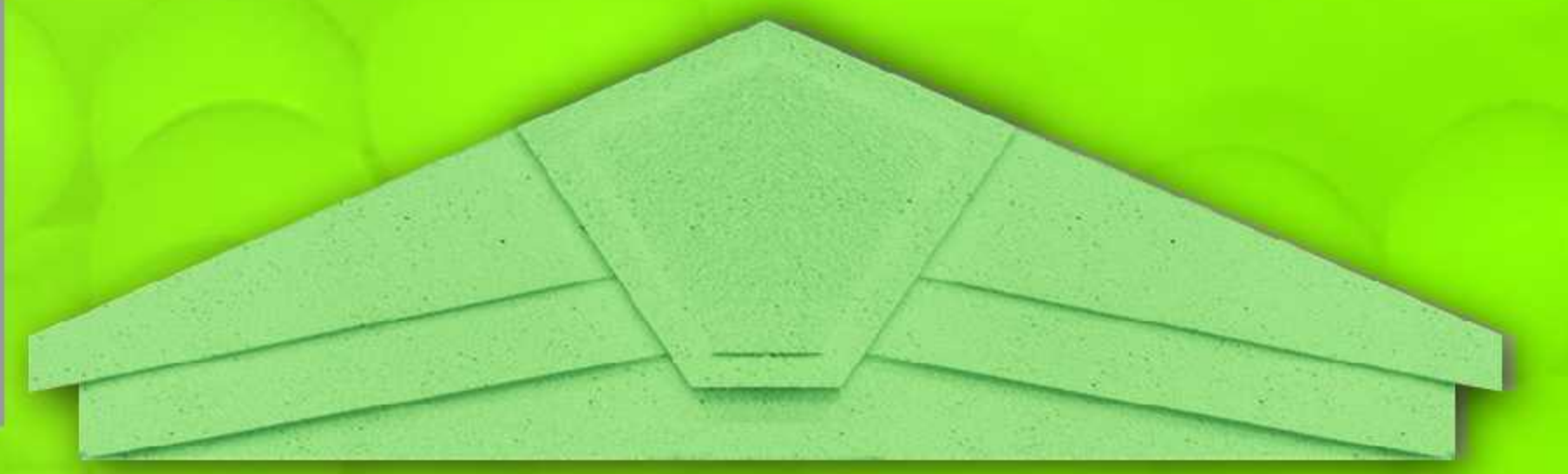
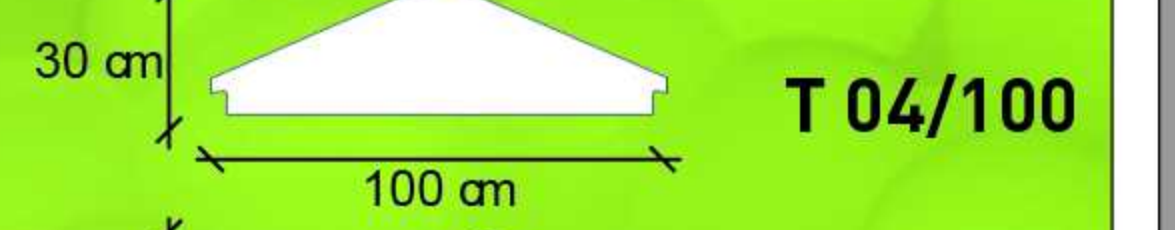
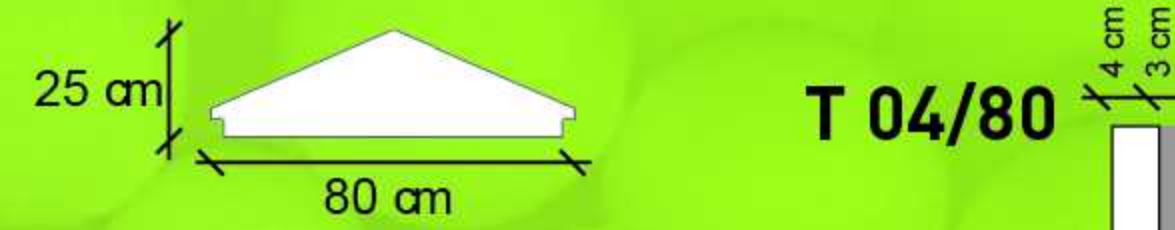
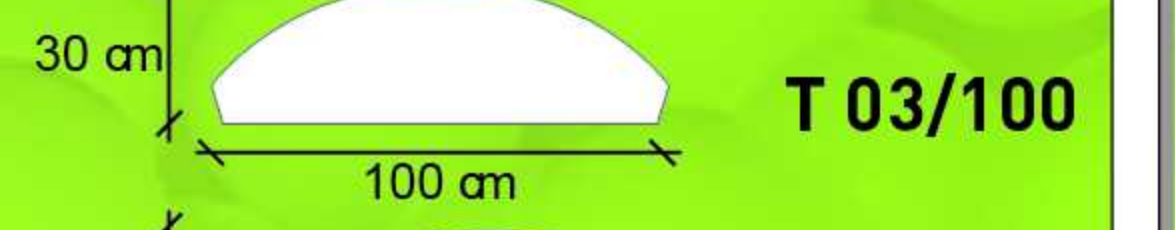
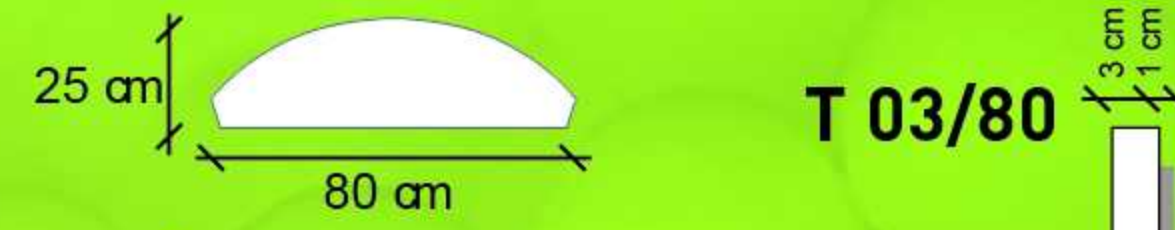
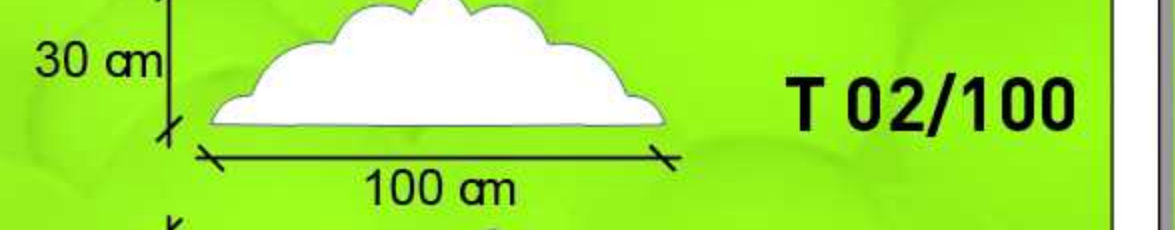
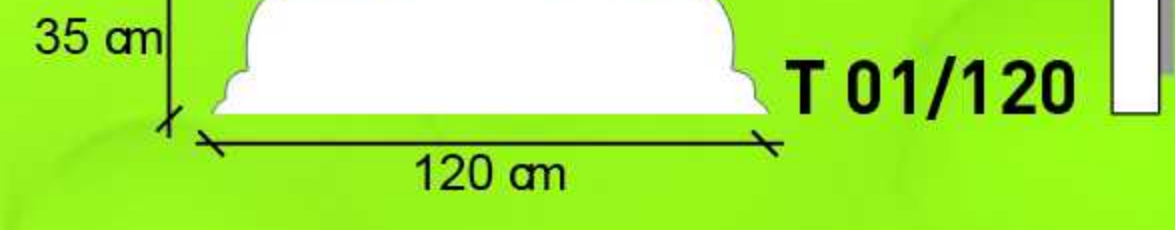
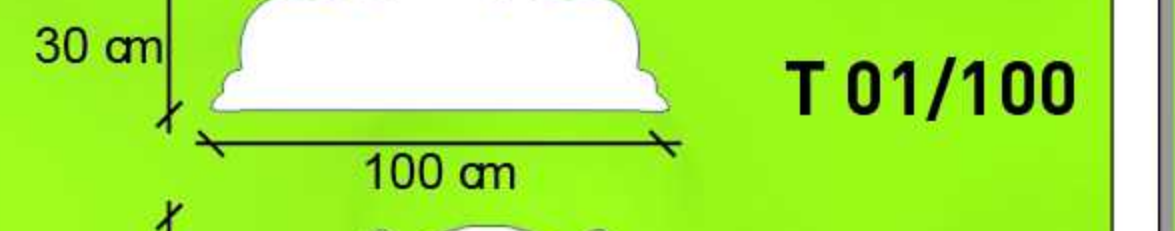
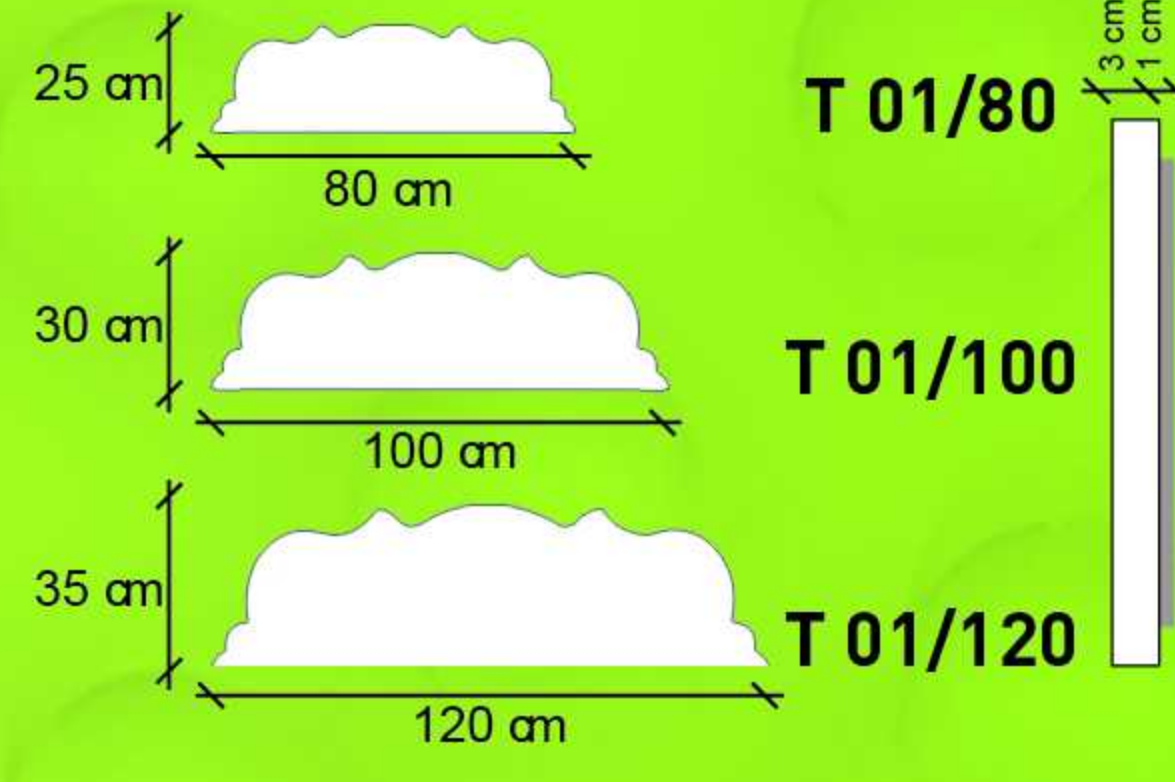
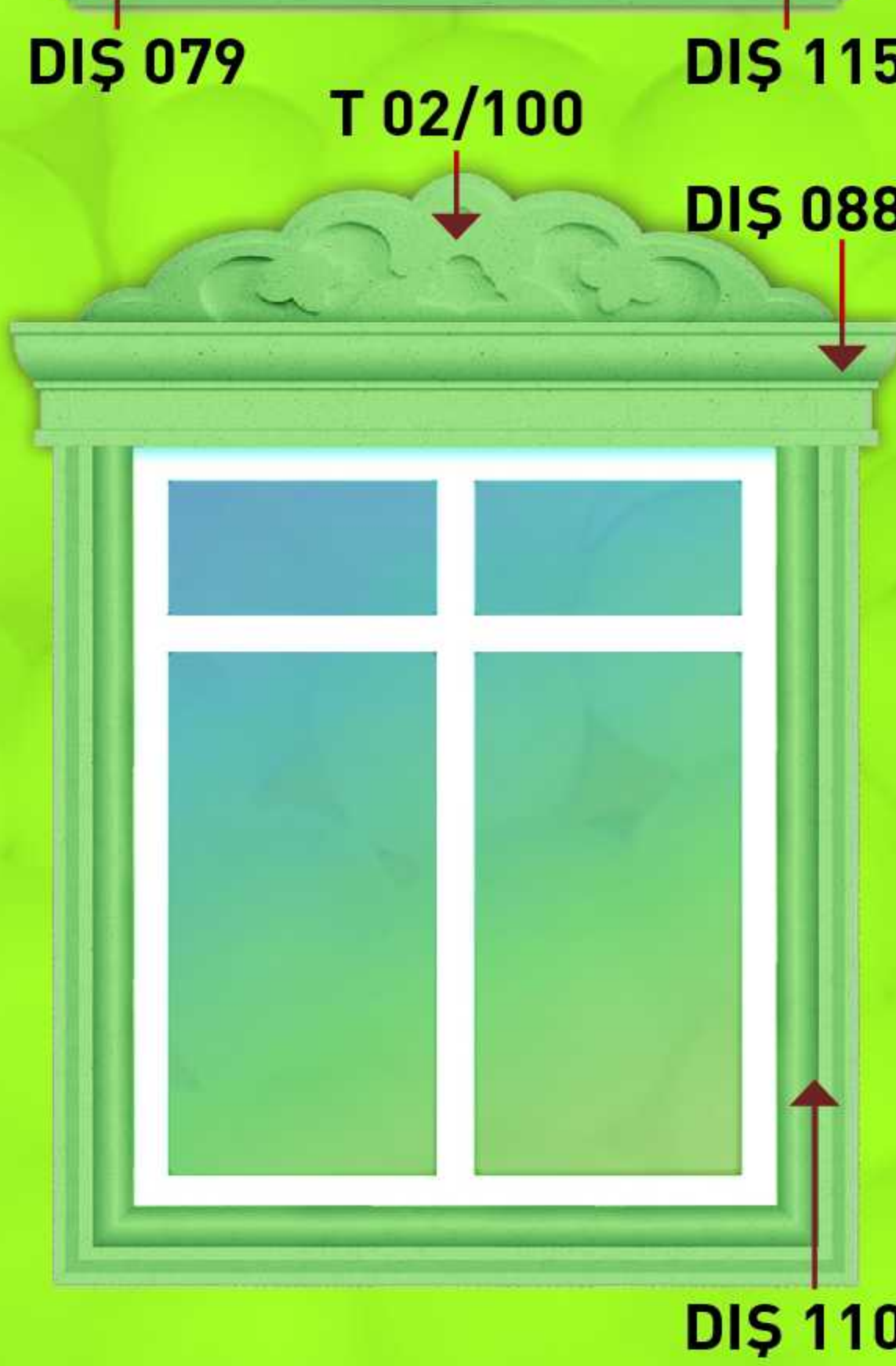
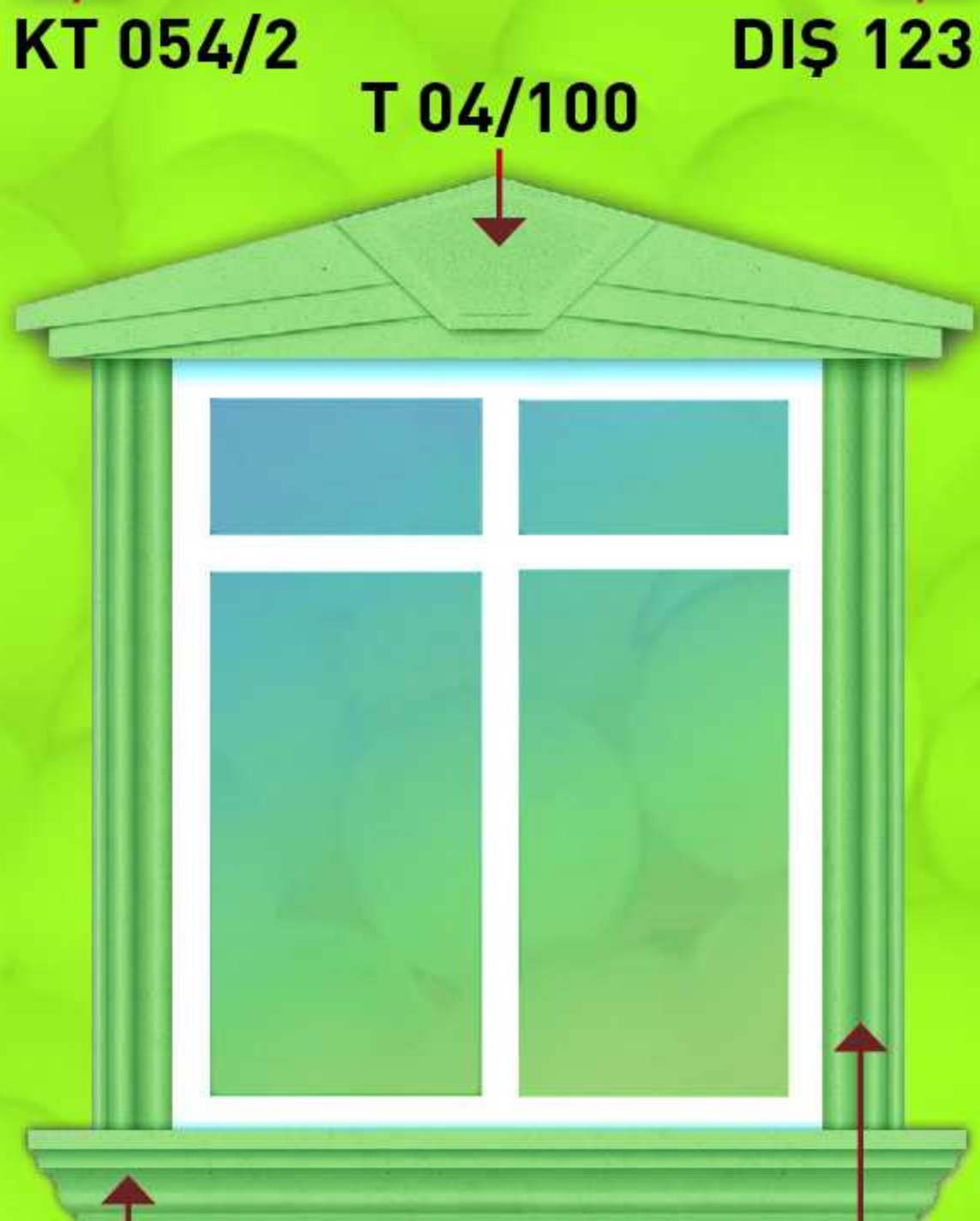
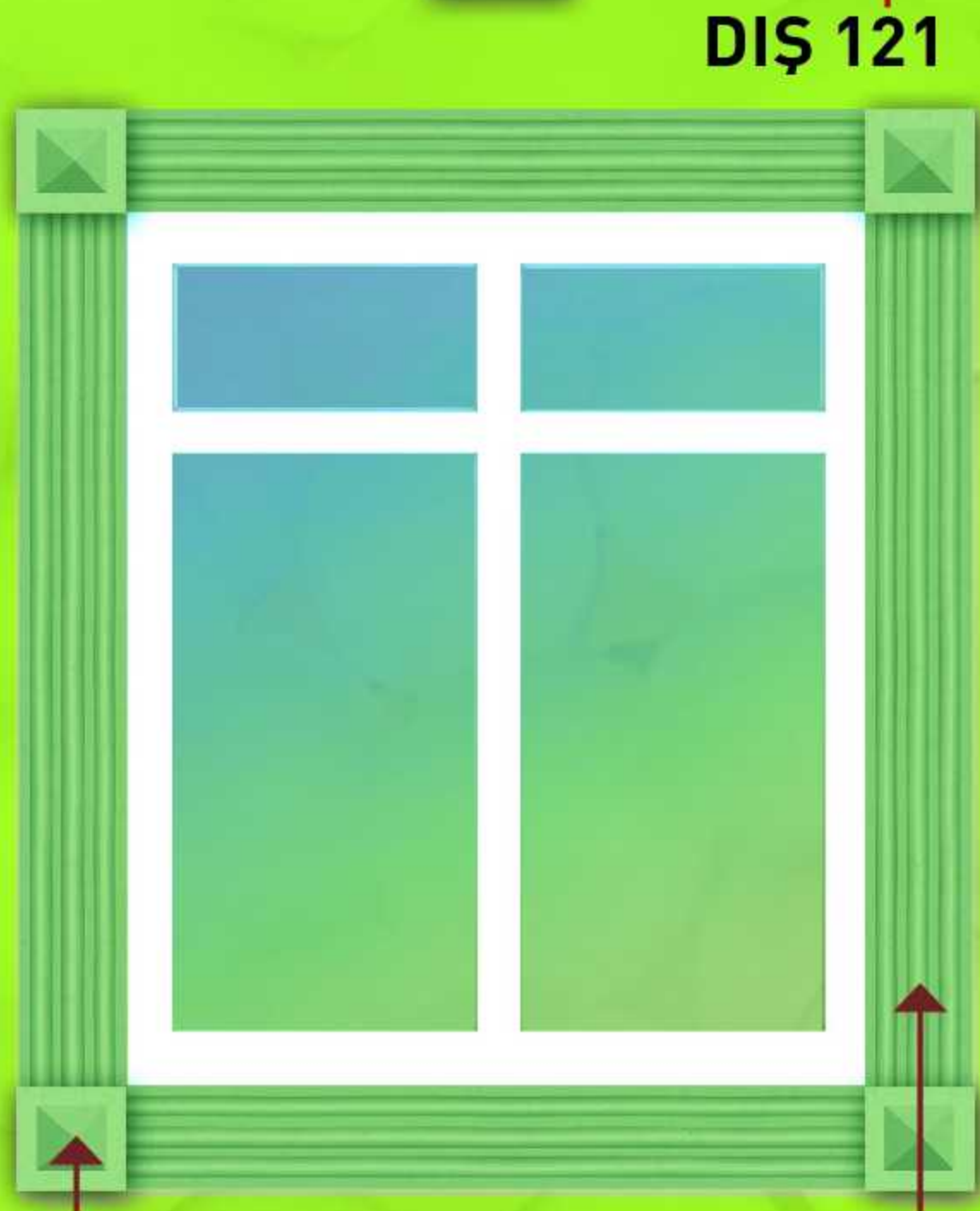
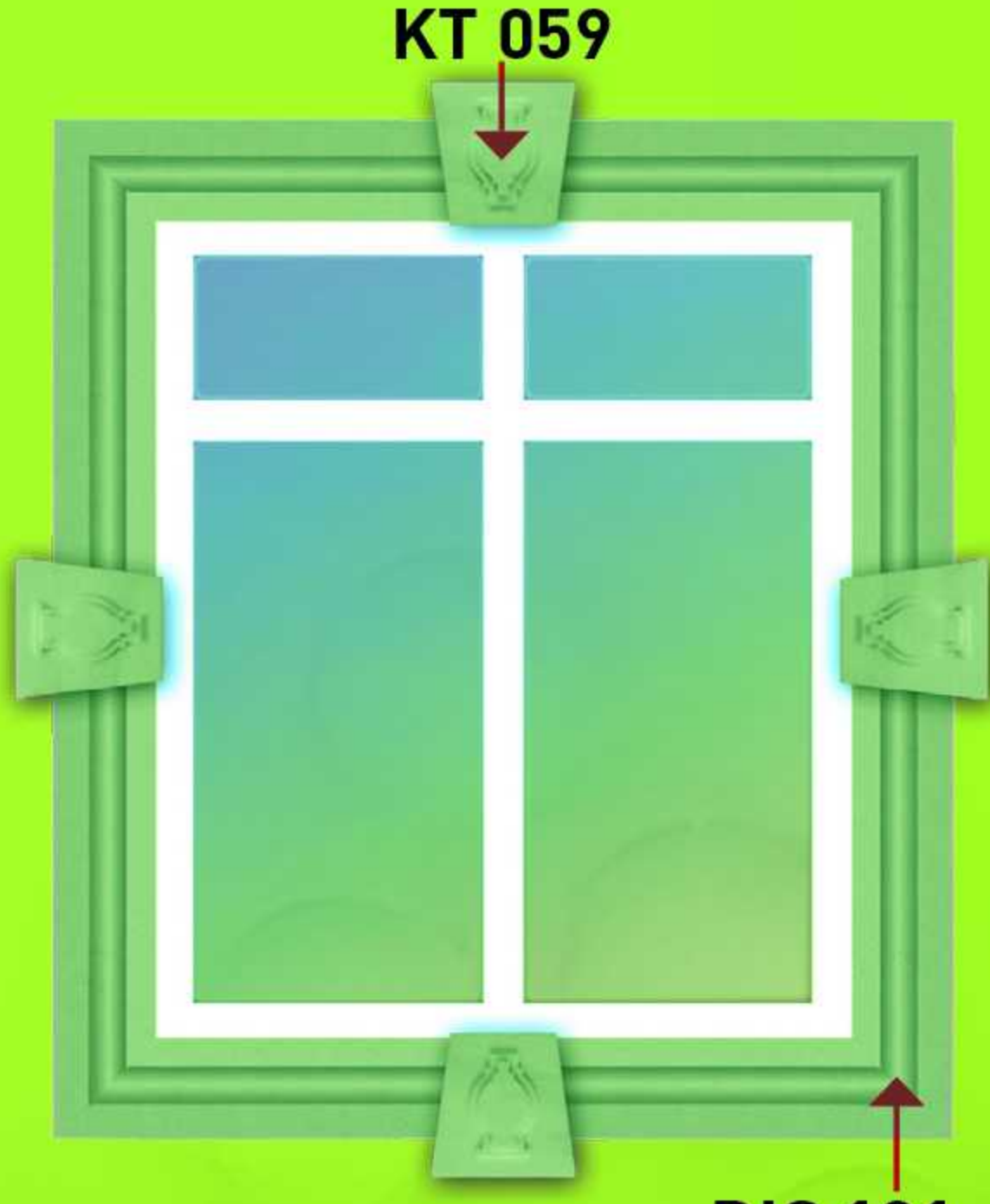

PENCERE DEKOR ÜRÜNLERİ

Window Decoration Products

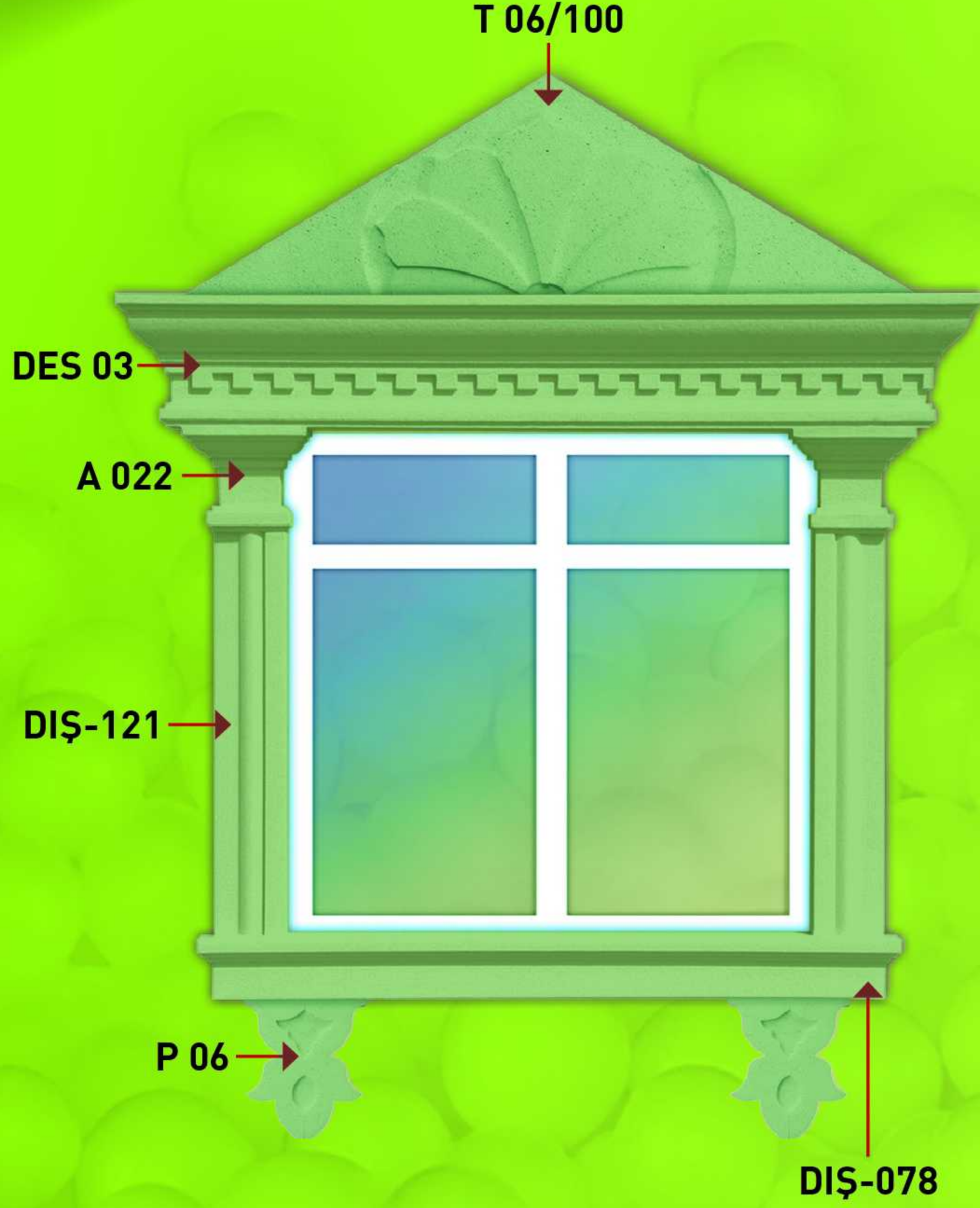

P 01/20



A: 20cm B: 40cm D: 4cm

P 01/15



A: 15cm B: 35cm D: 4cm

P 01/10



A: 10cm B: 30cm D: 3cm

P 03/20



A: 20cm B: 35cm D: 4cm

P 03/15



A: 15cm B: 30cm D: 4cm

P 03/10



A: 10cm B: 25cm D: 3cm

P 04/20



A: 20cm B: 30cm D: 4cm

P 04/15



A: 15cm B: 25cm D: 4cm

P 04/10



A: 10cm B: 20cm D: 3cm

P 05/20



A: 20cm B: 40cm D: 4cm

P 05/15

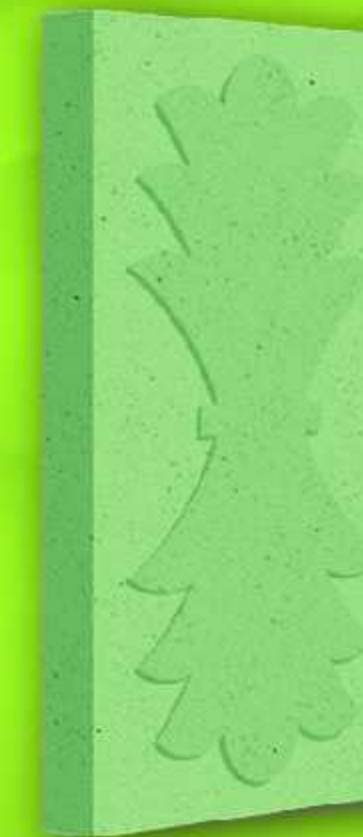

A: 15cm B: 35cm D: 4cm

P 05/10



A: 10cm B: 30cm D: 3cm

P 10/20

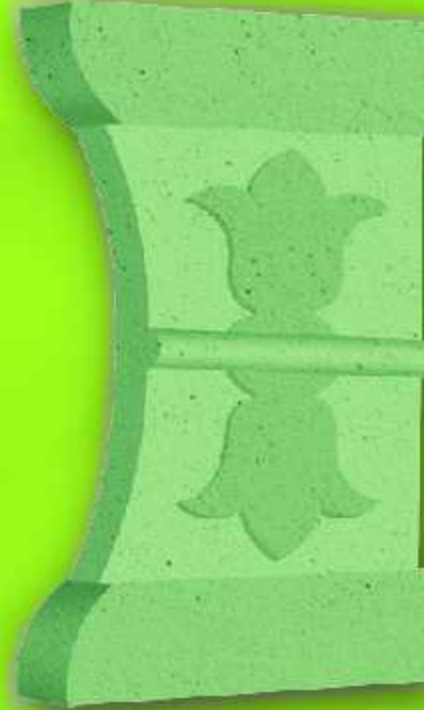

A: 20cm B: 30cm D: 4cm

P 10/15

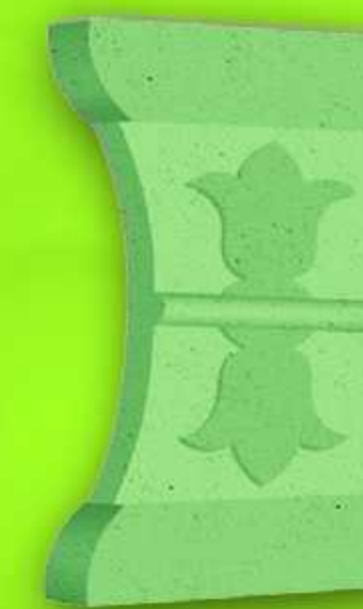

A: 15cm B: 25cm D: 4cm

P 10/10



A: 10cm B: 20cm D: 3cm

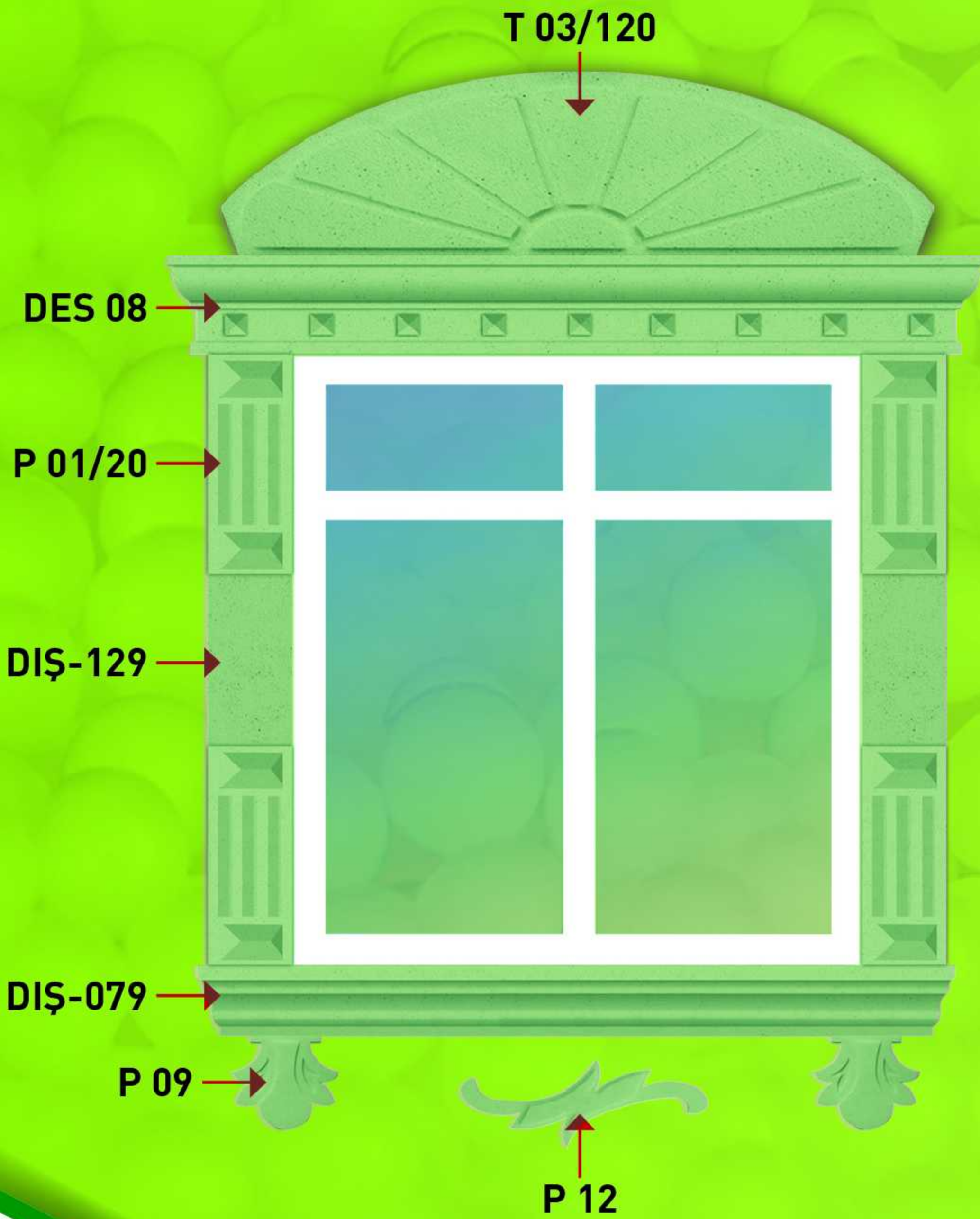

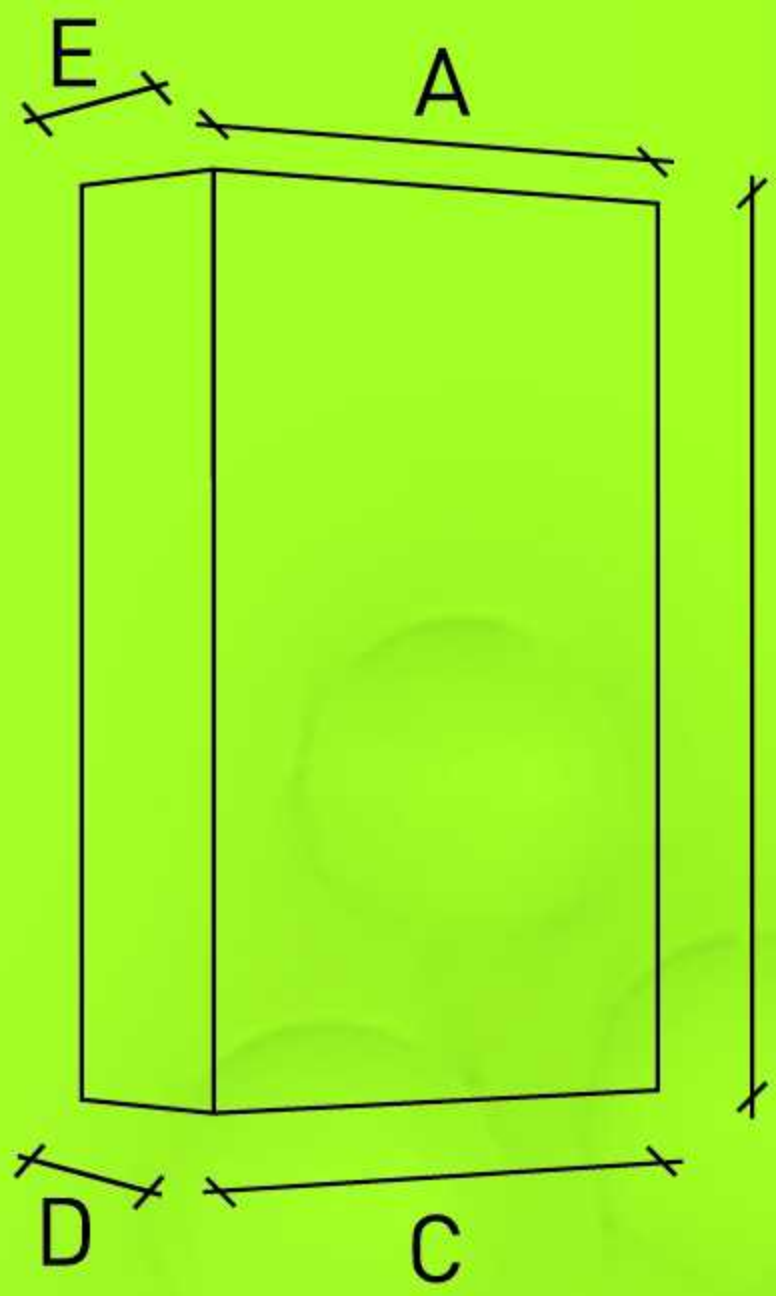

P 08
A: 9cm B: 18cm D: 1cm



A: 10cm B: 15cm D: 1,5cm



A: 20cm B: 30cm D: 2cm



A: 19cm B: 25cm D: 1,5cm



A: 12cm B: 25cm D: 1cm



A: 20cm B: 40cm D: 4cm



A: 15cm B: 35cm D: 4cm



A: 10cm B: 30cm D: 3cm



A 029

A: 16cm
B: 20cm
C: 11cm
D: 5cm
E: 9,5cm



A 032

A: 21cm
B: 15cm
C: 15cm
D: 4cm
E: 7cm



A 023

A: 11cm
B: 16cm
C: 11cm
D: 4cm
E: 10cm



A 025

A: 12cm
B: 12cm
C: 12cm
D: 2cm
E: 4,5cm



A 010

A: 17cm
B: 30cm
C: 17cm
D: 8cm
E: 8cm



A 033

A: 16cm
B: 27cm
C: 13cm
D: 1,5cm
E: 4,5cm



A 027

A: 20cm
B: 25cm
C: 20cm
D: 1,5cm
E: 8cm



A 013

A: 35cm
B: 24,5cm
C: 23cm
D: 4cm
E: 10cm



A 022

A: 24cm
B: 20cm
C: 14,5cm
D: 10cm
E: 15cm

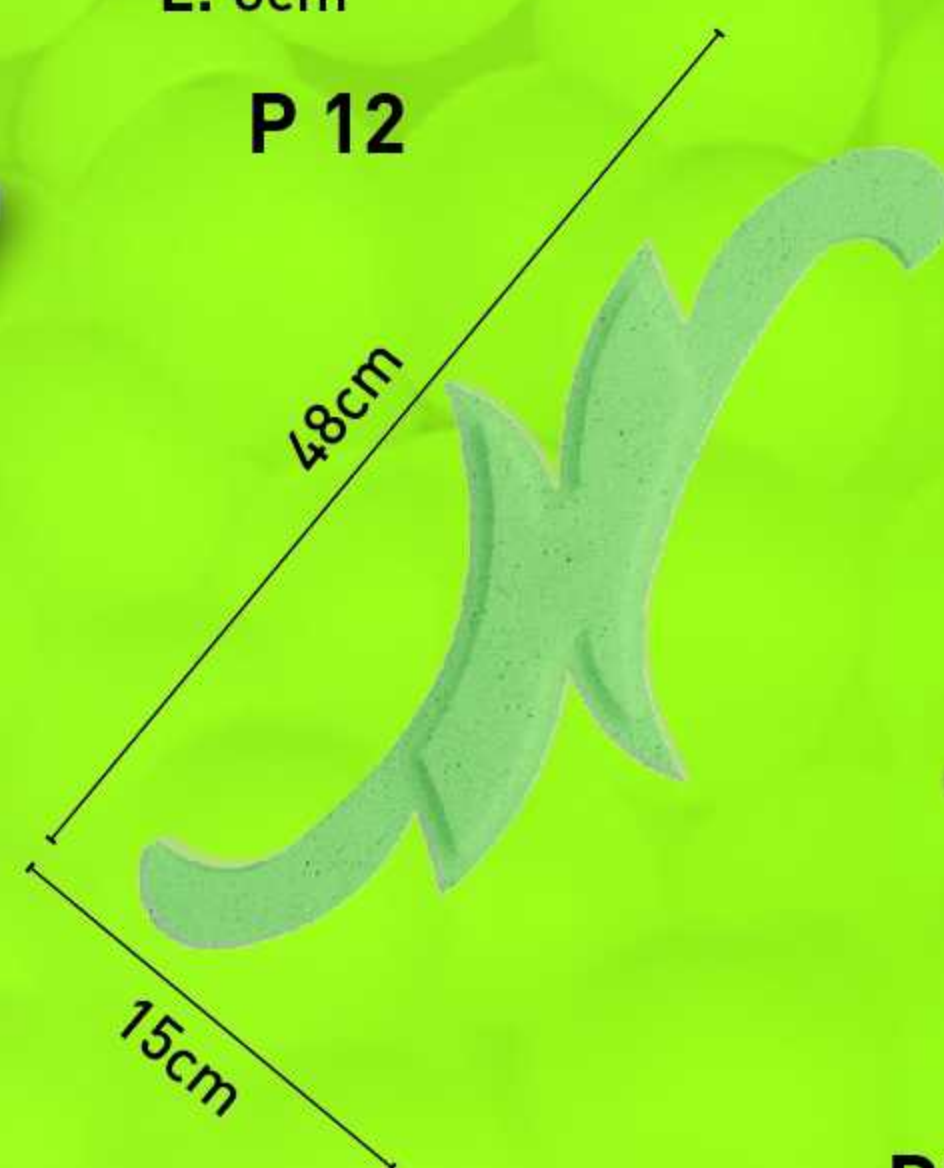

P 12

48cm

15cm

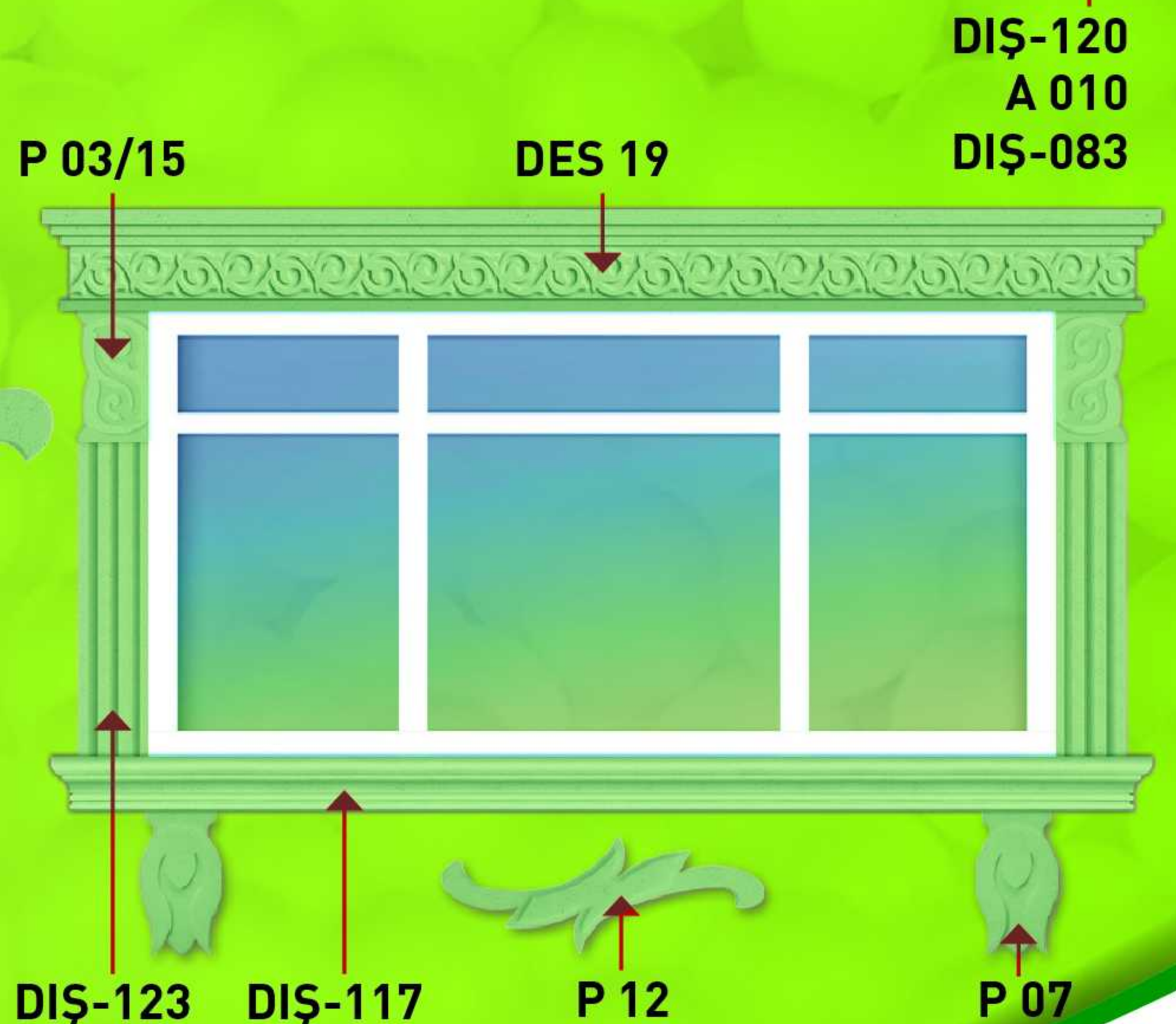
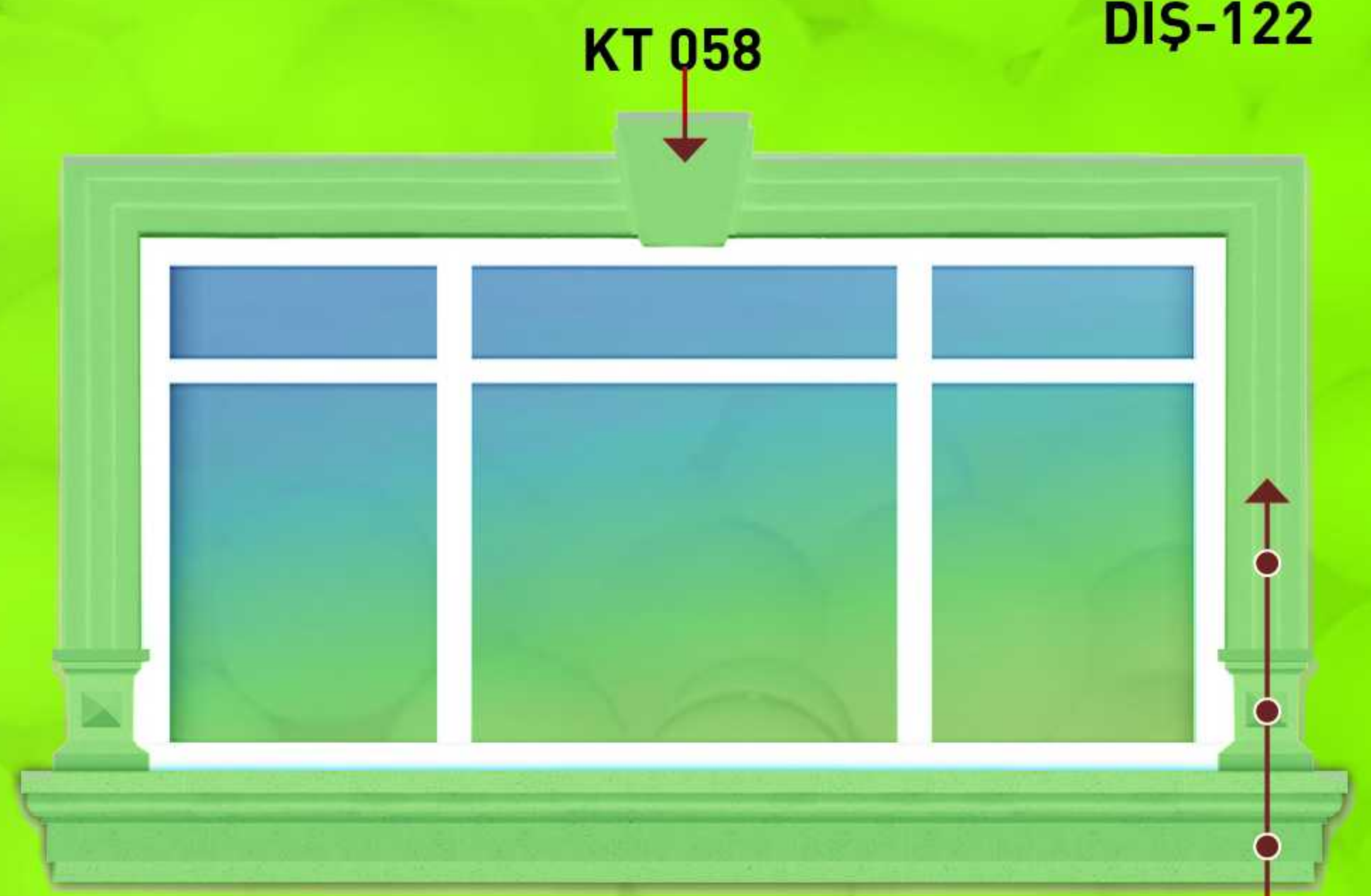

DIŞ CEPHE MOTİFLERİ

Exterior Motives



BLK 05



33cm x 50cm

BLK 07



44cm x 44cm

BLK 06

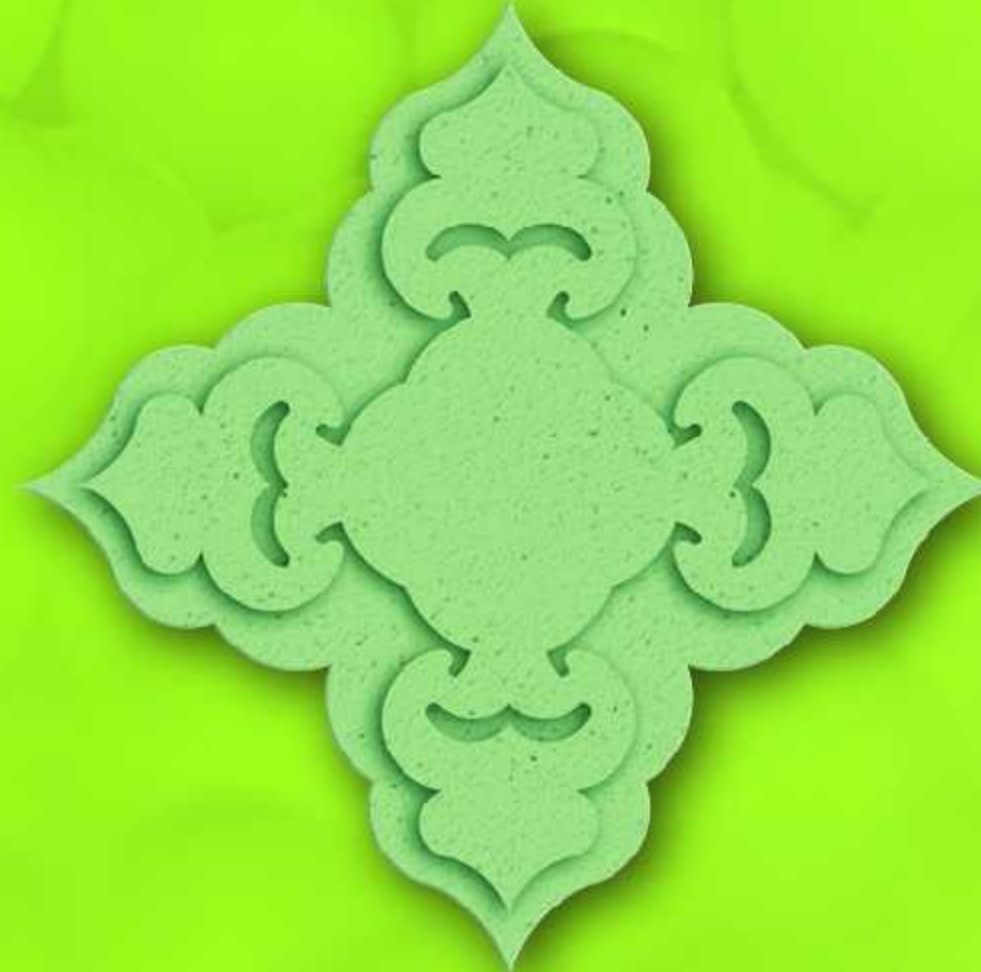

56cm x 56cm

BLK 04



63cm x 29cm



MTF 01

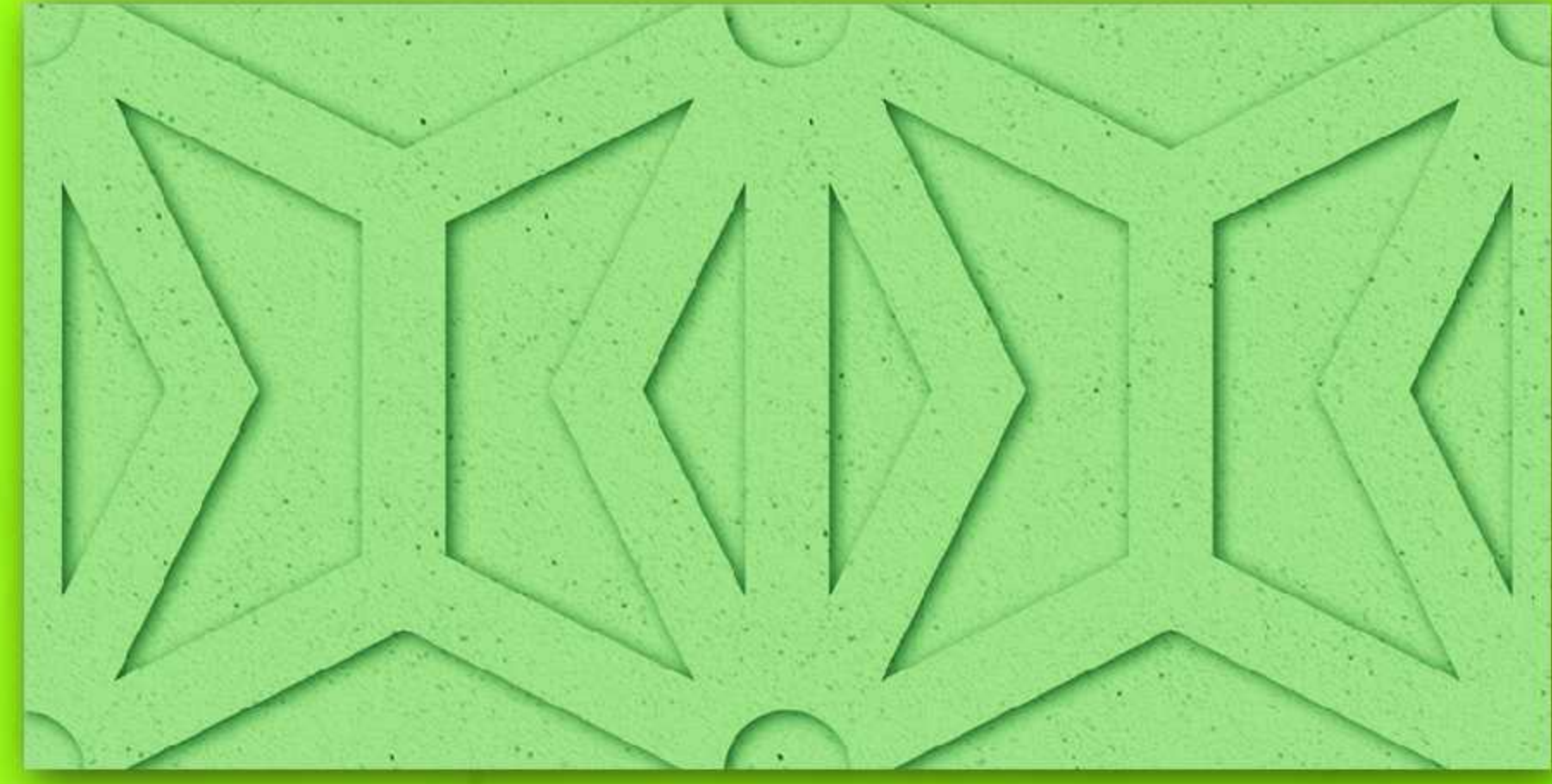

50cm x 100cm

3.5 cm
0.5 cm

MTF 02

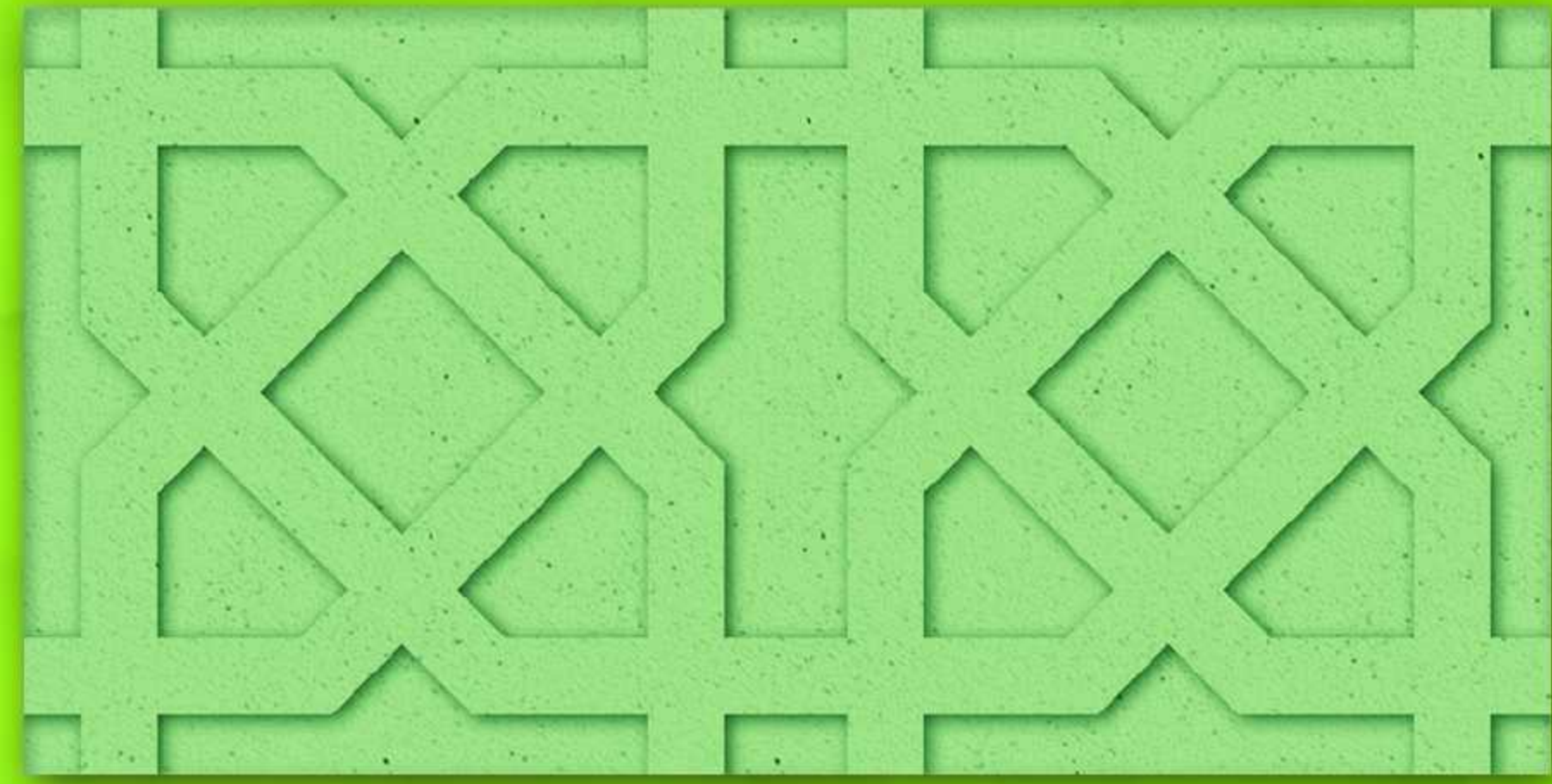

50cm x 100cm

3.5 cm
0.5 cm

MTF 03

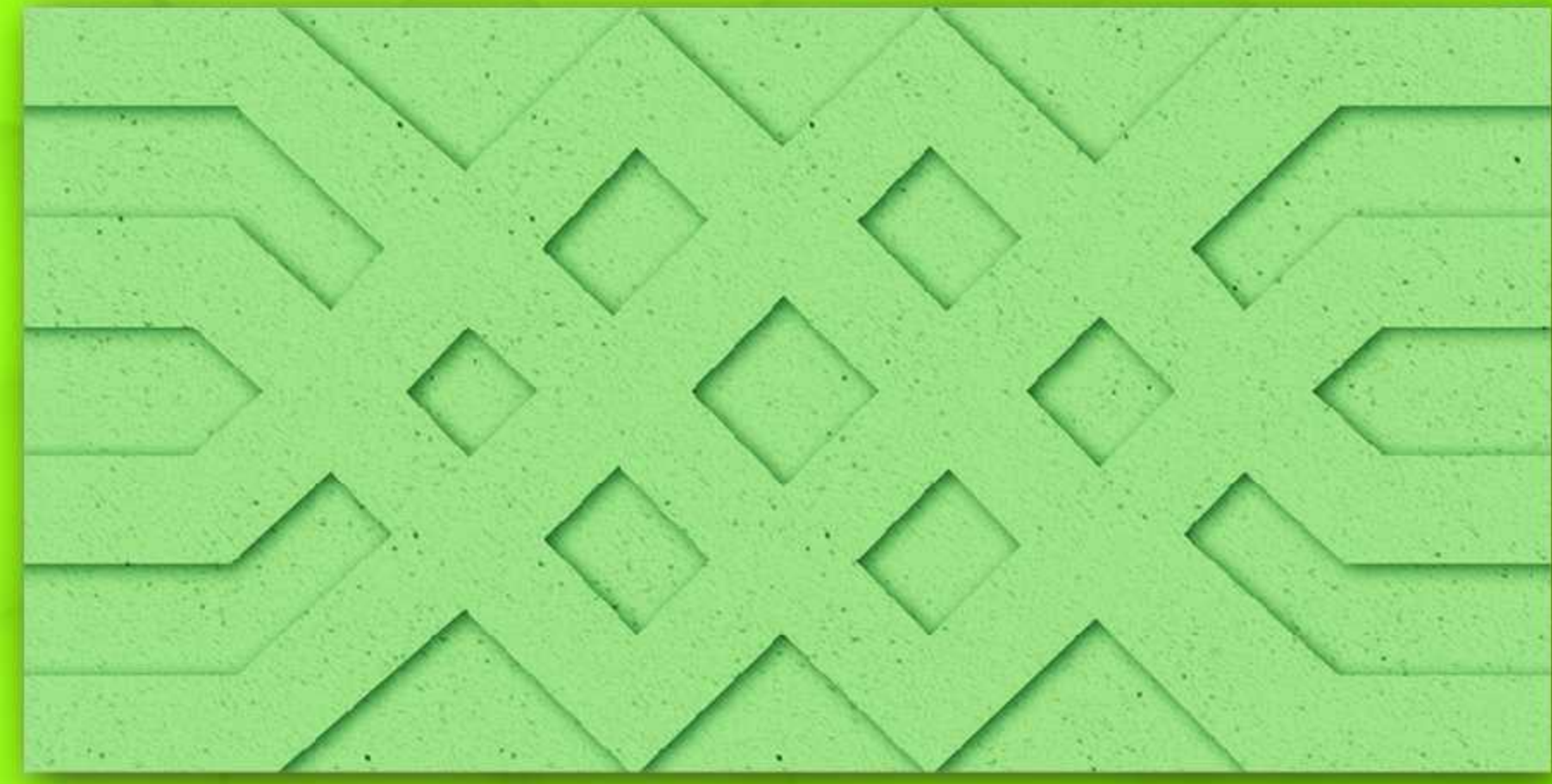

50cm x 100cm

3.5 cm
0.5 cm

BLK 01



42cm x 93cm

3.5 cm
0.5 cm

BLK 02



68cm x 68cm

3.5 cm
0.5 cm

BLK 03

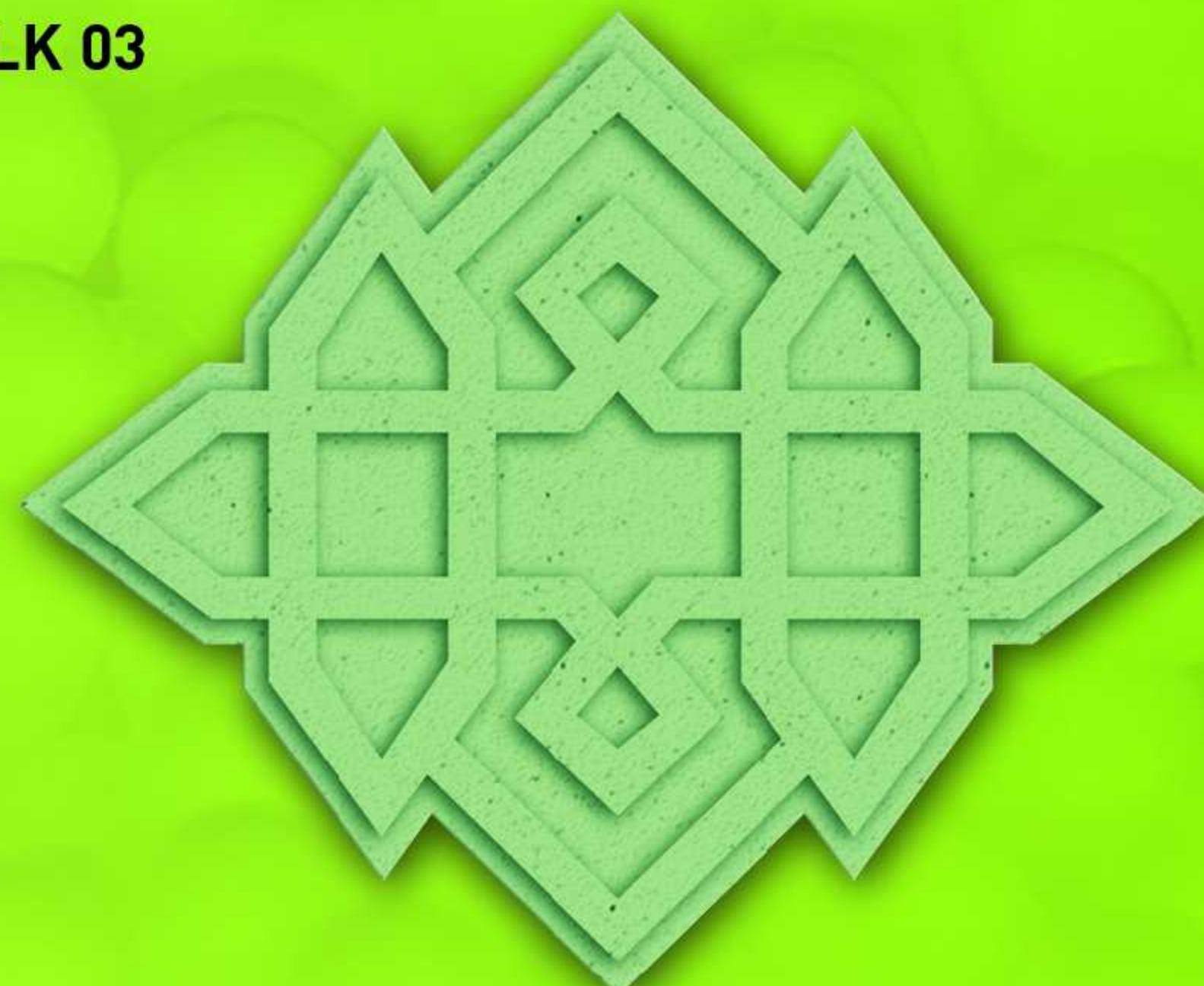

73cm x 89cm

3.5 cm
0.5 cm



PAYANDALAR

Buttress

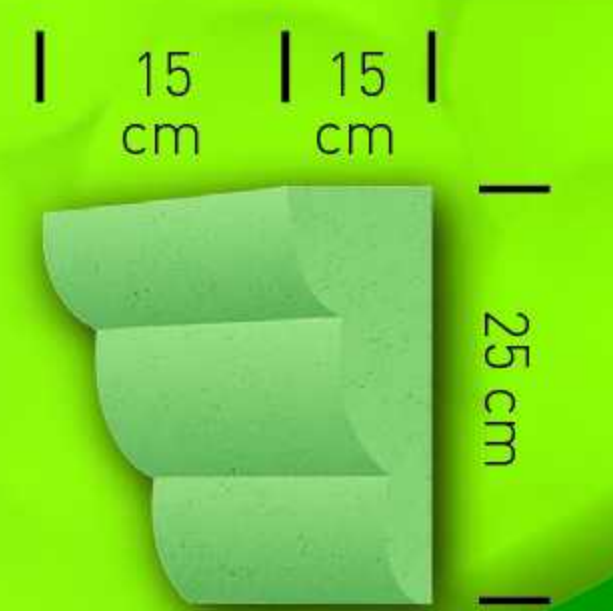
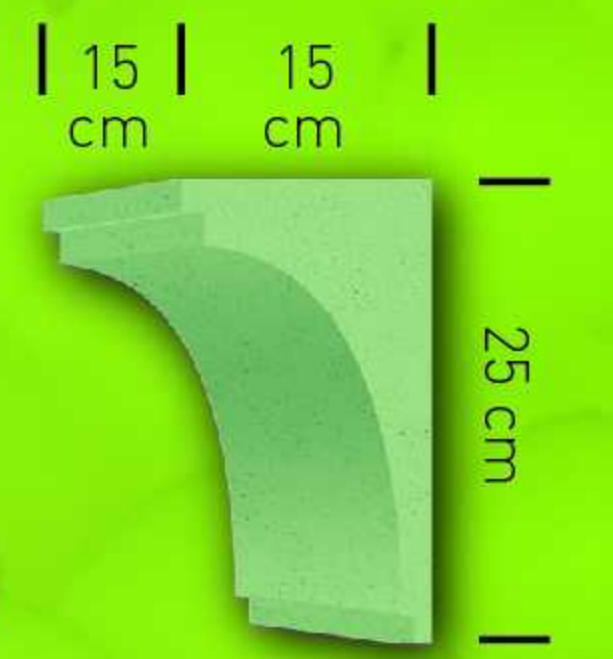
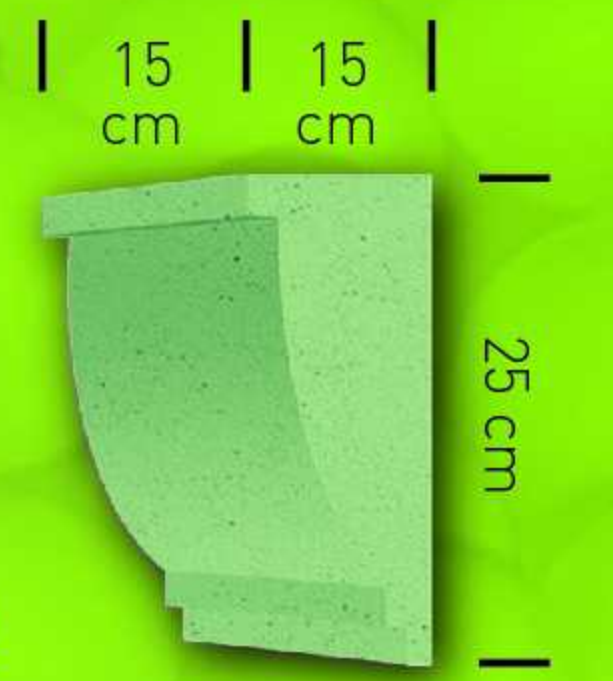
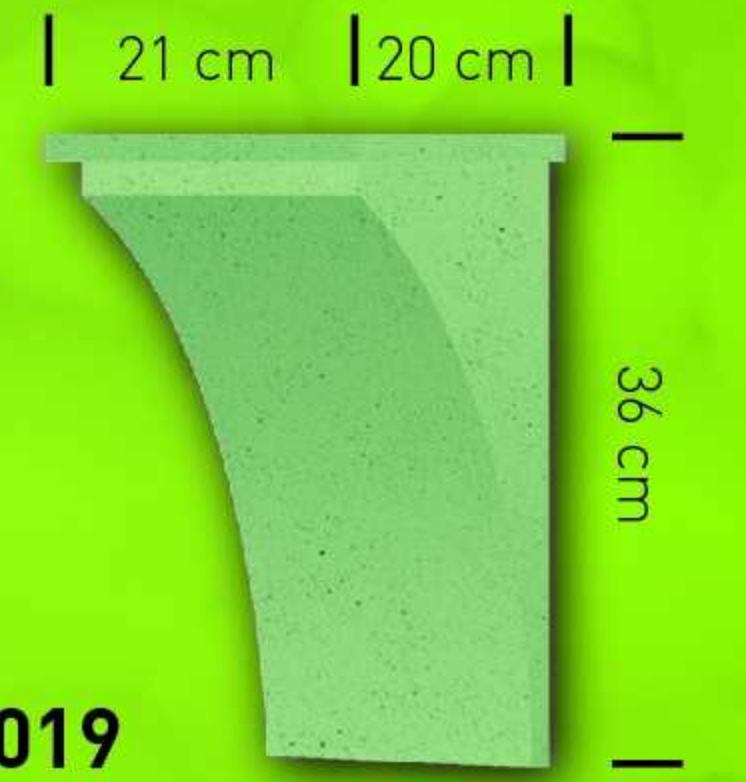
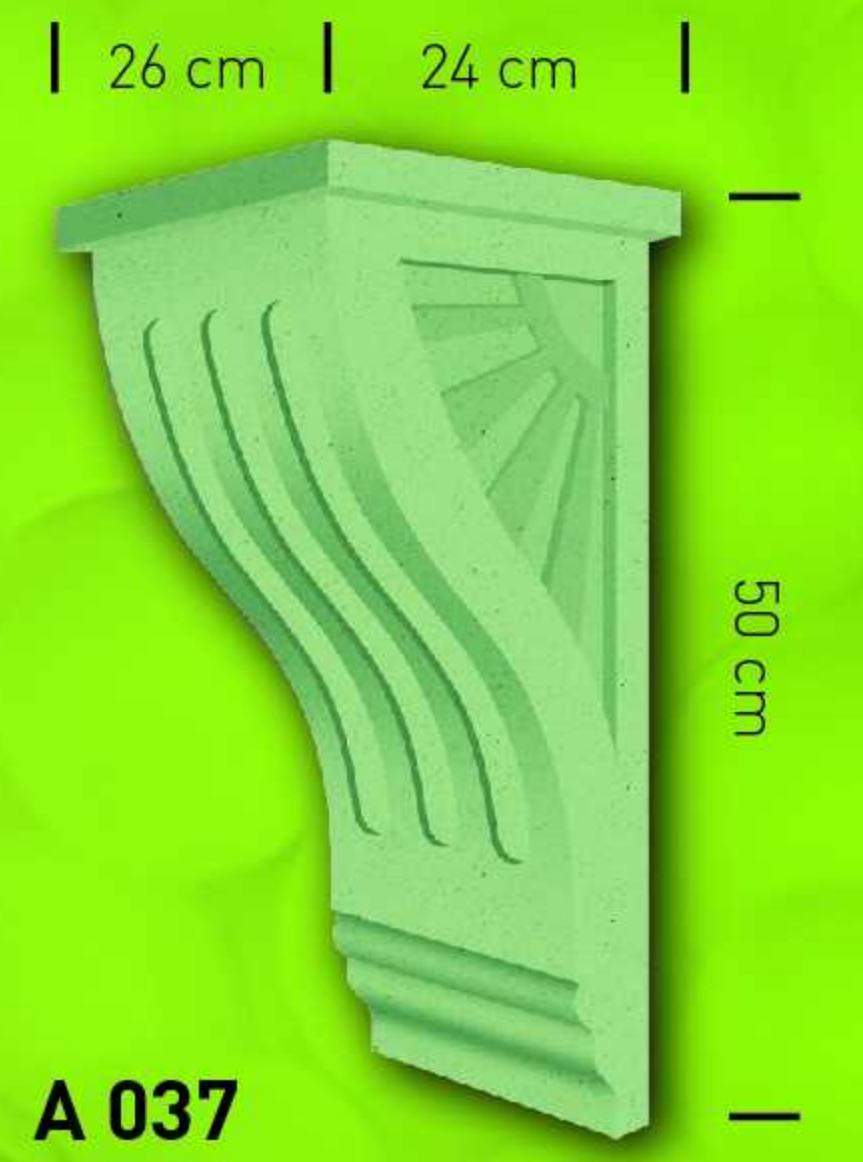
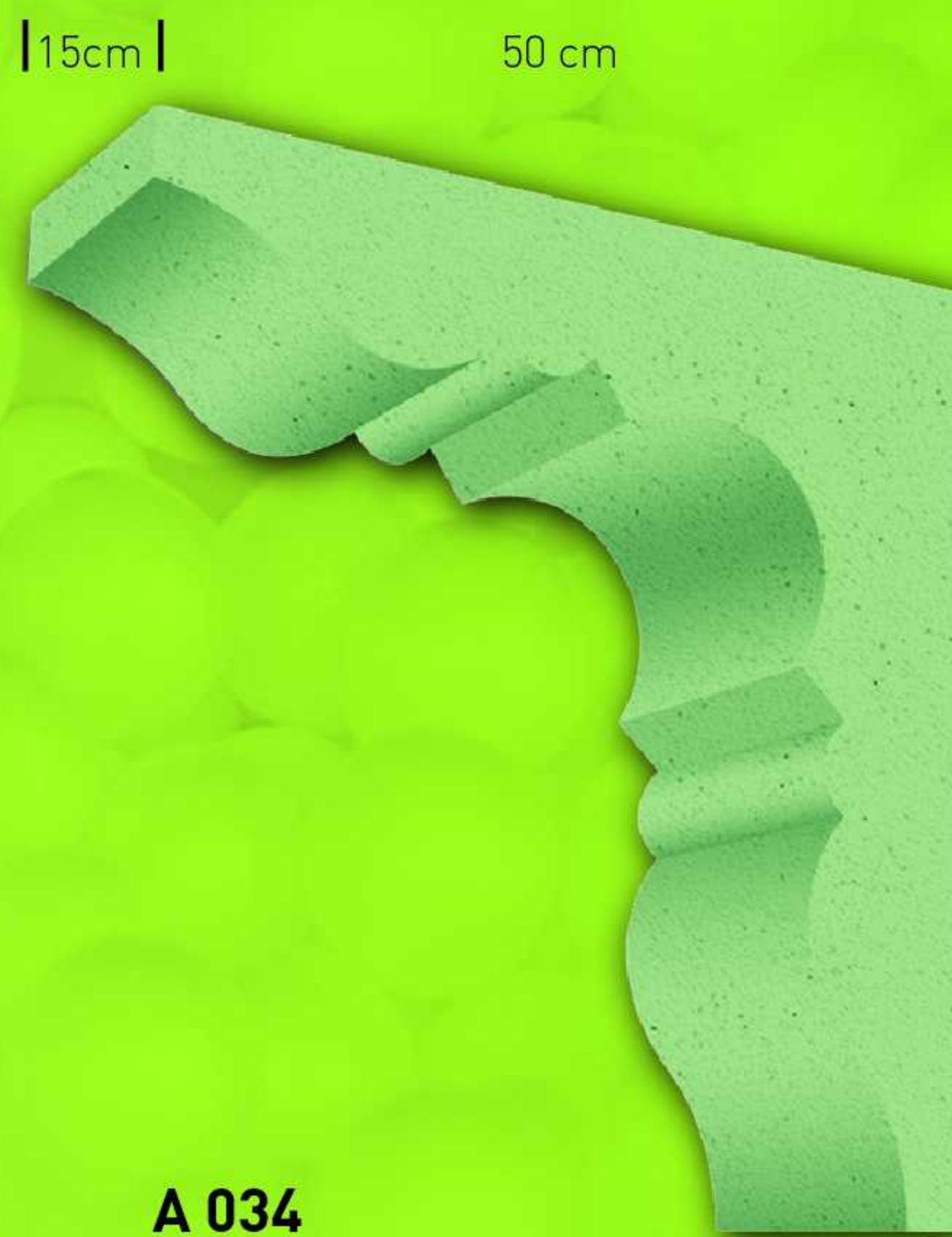
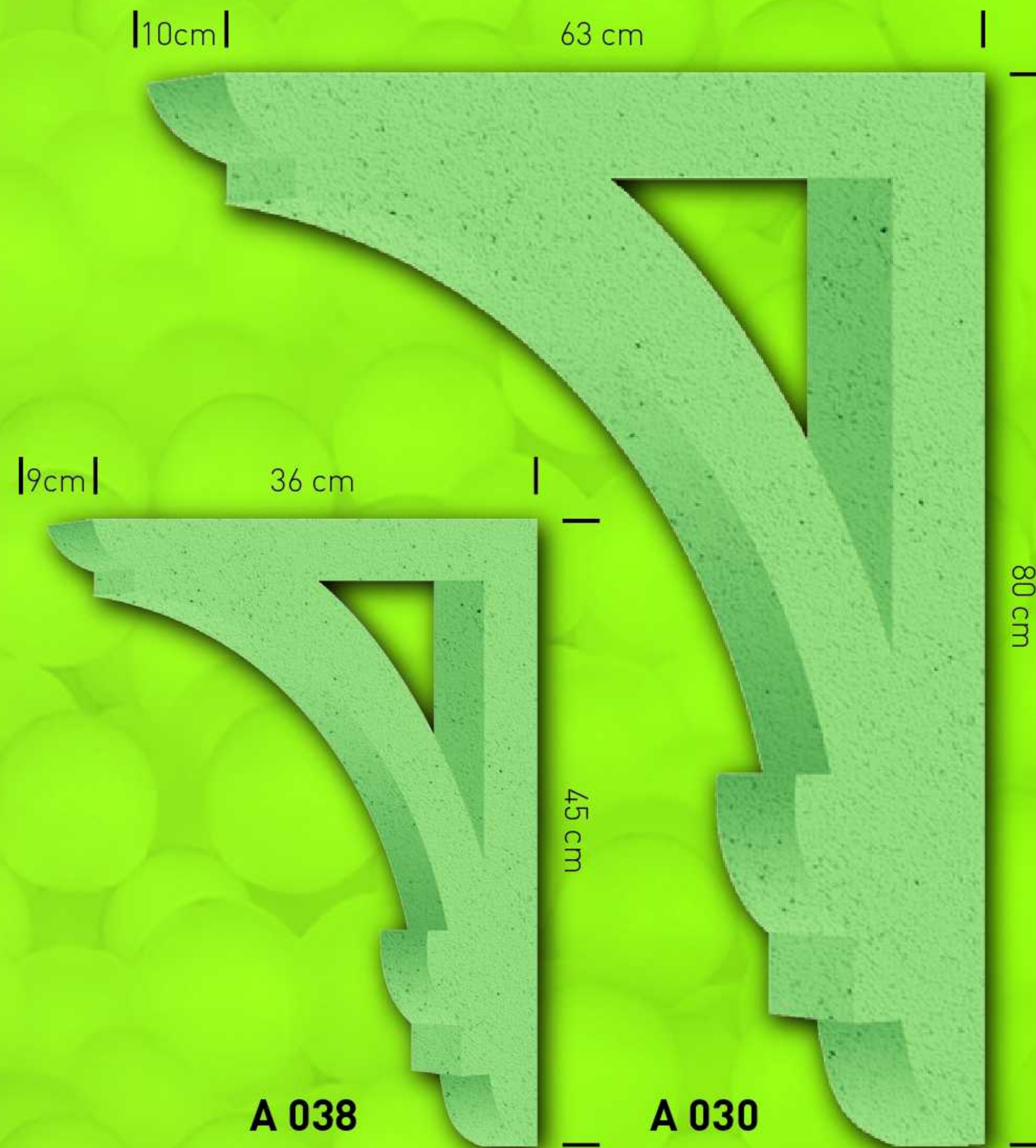
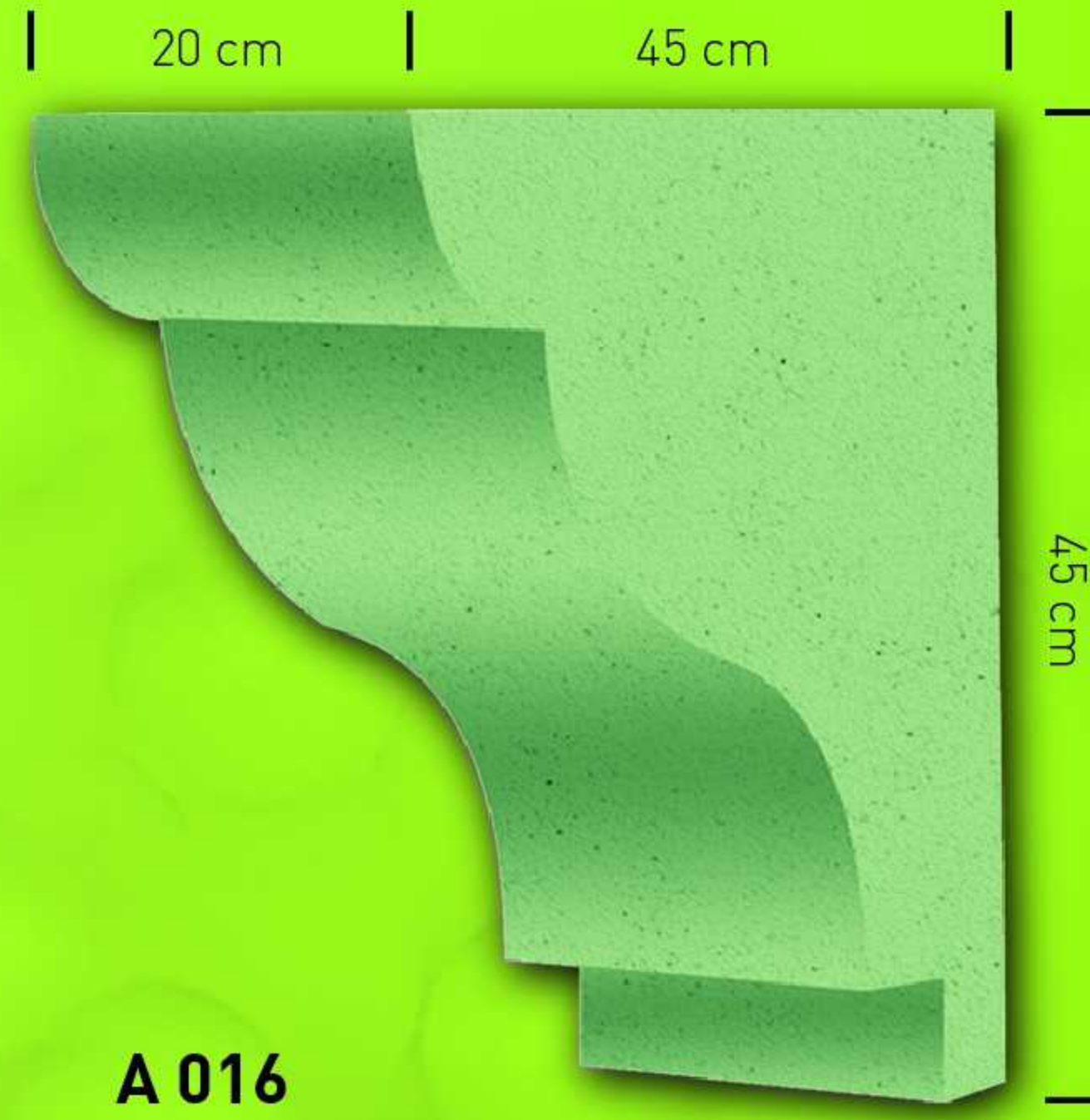
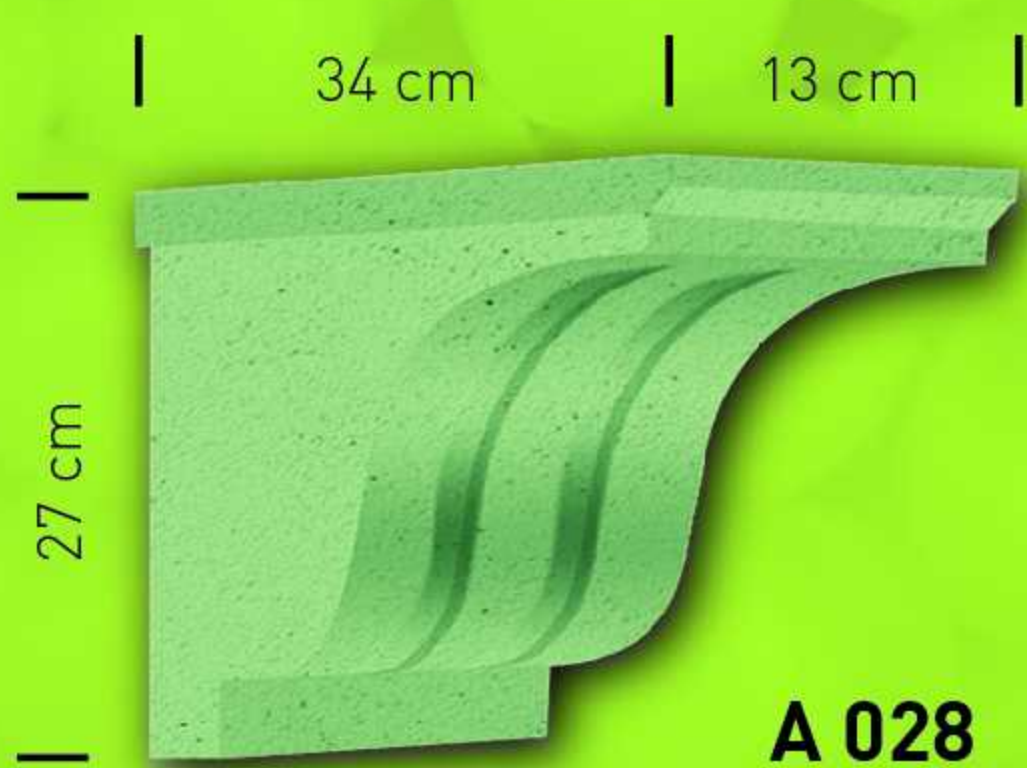
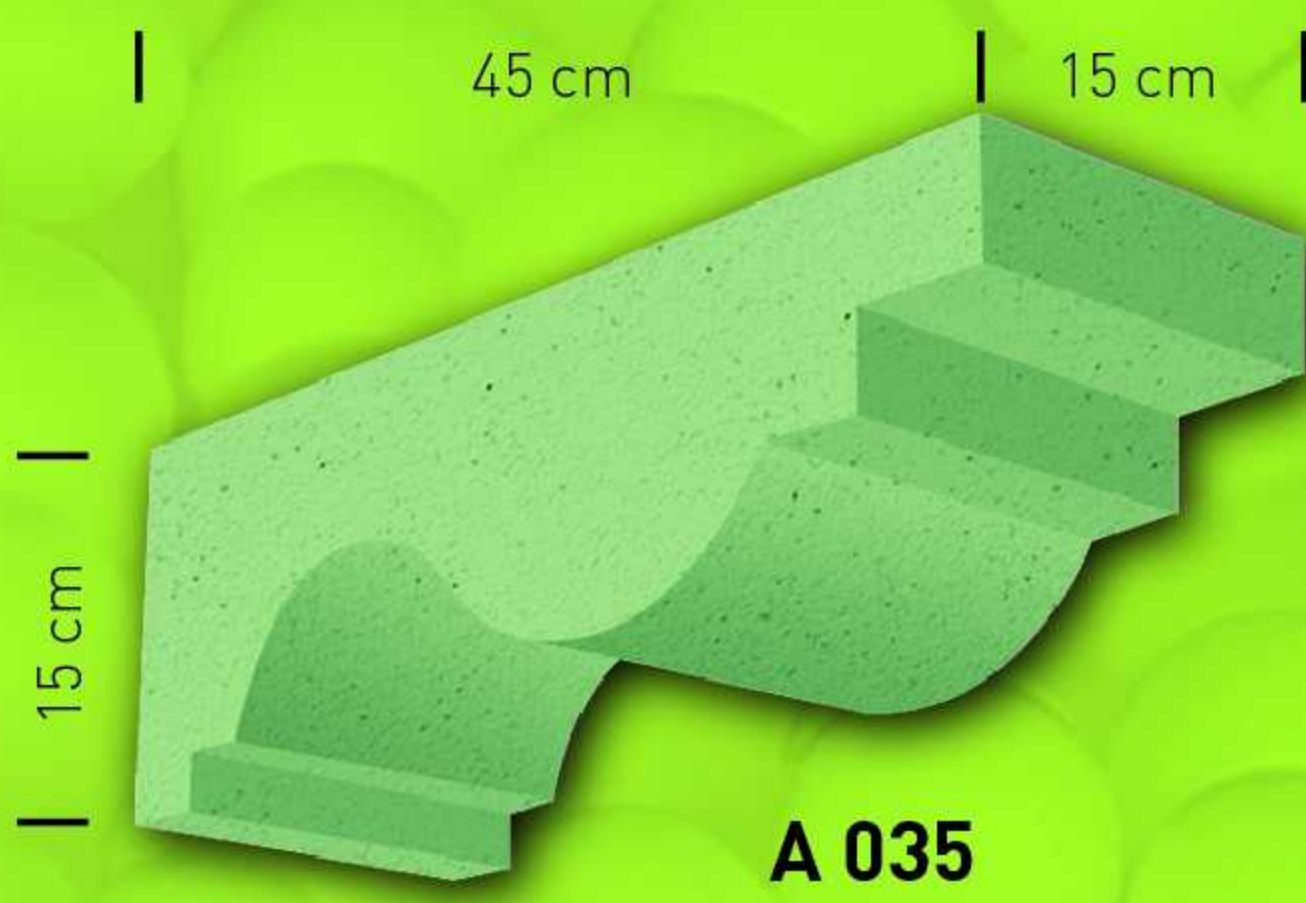
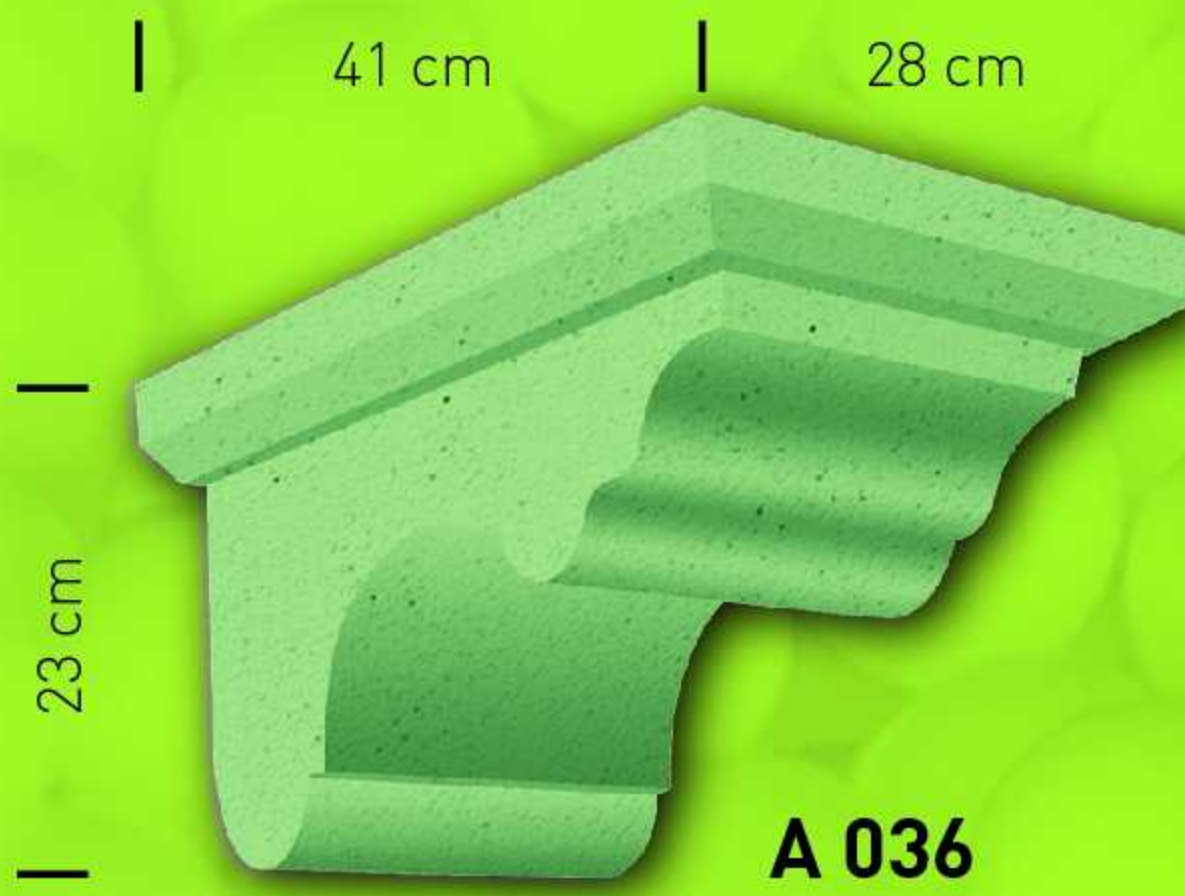
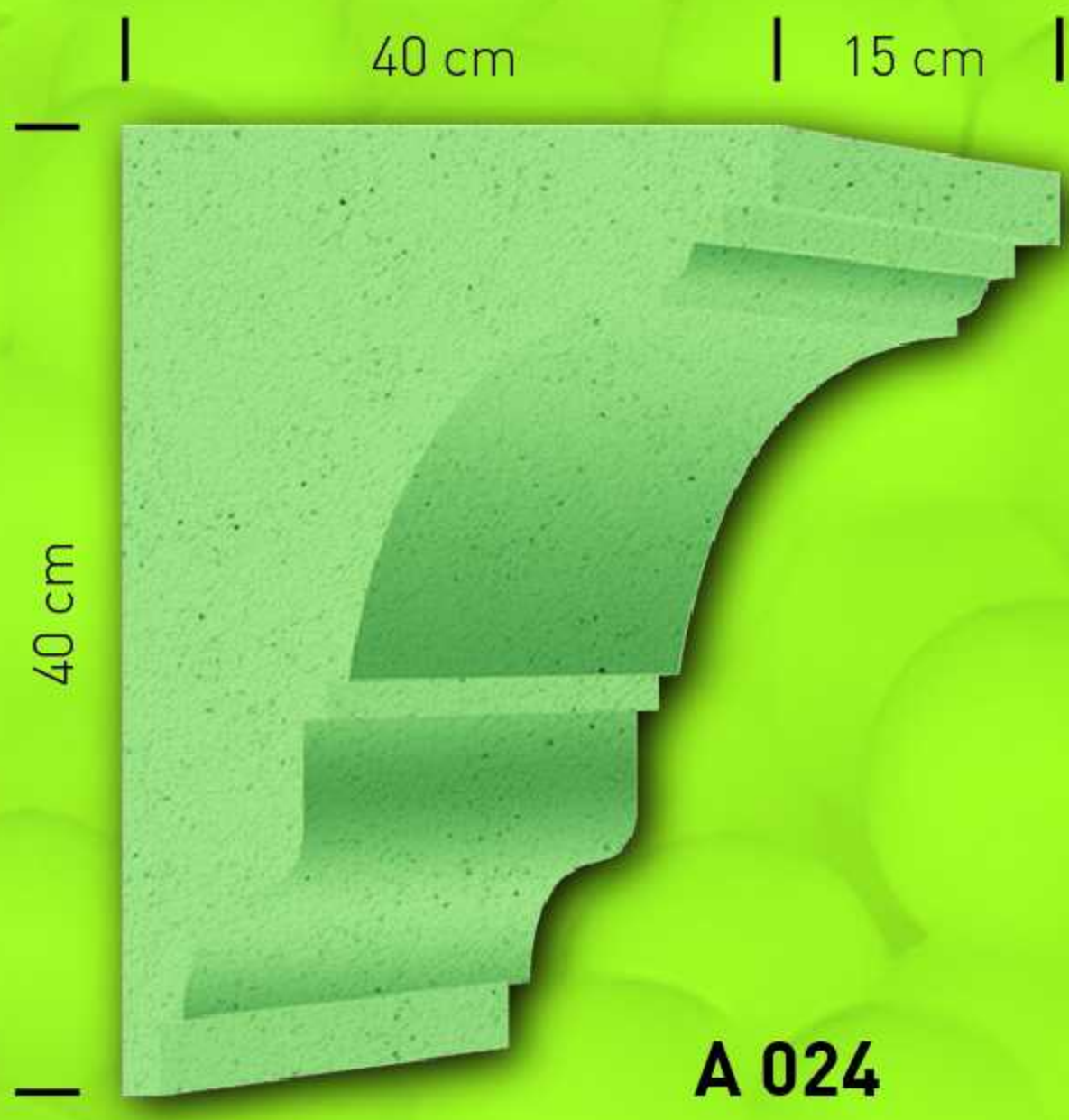
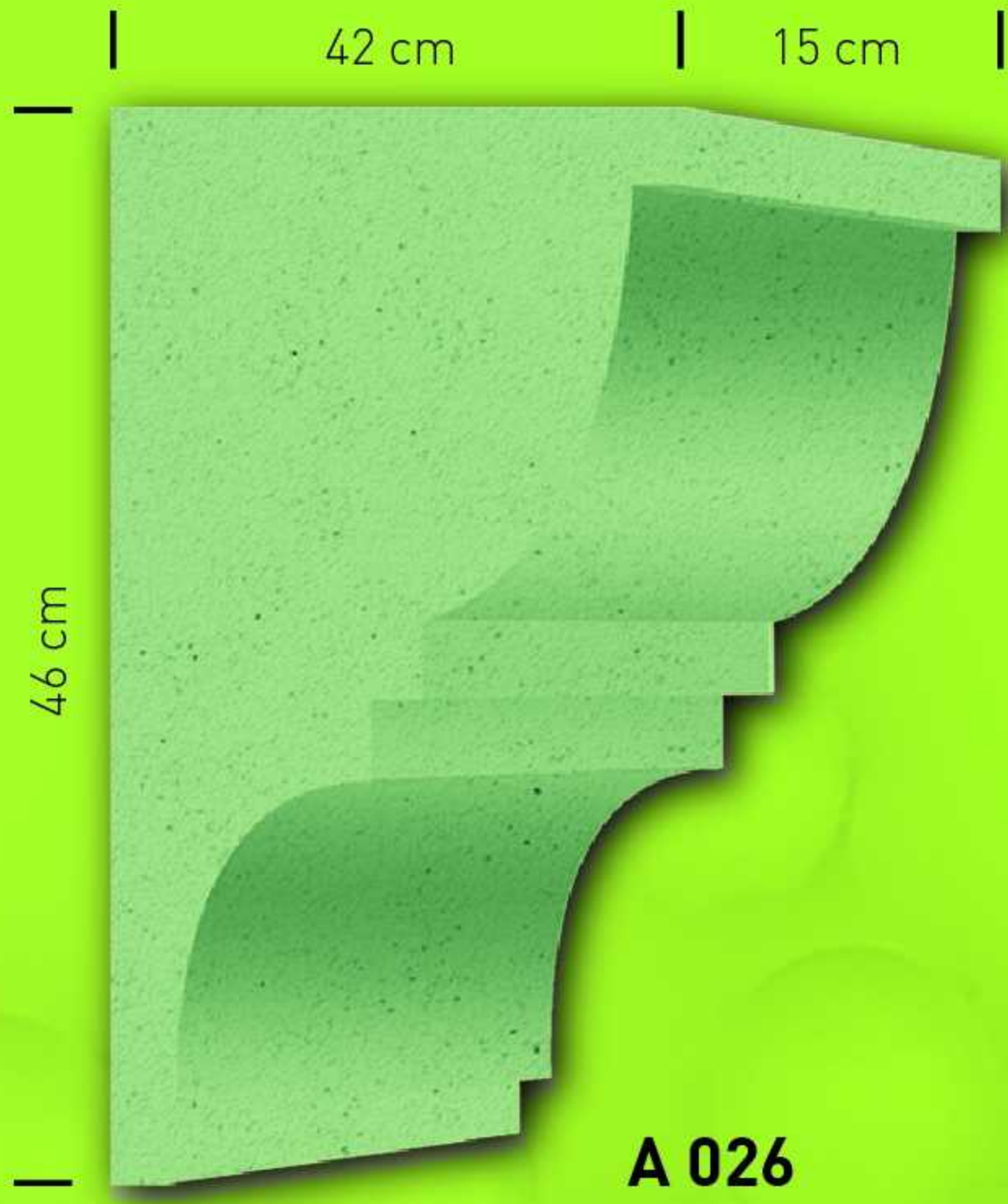

SÜTUN VE KAİDELER

Columns and Pedestals

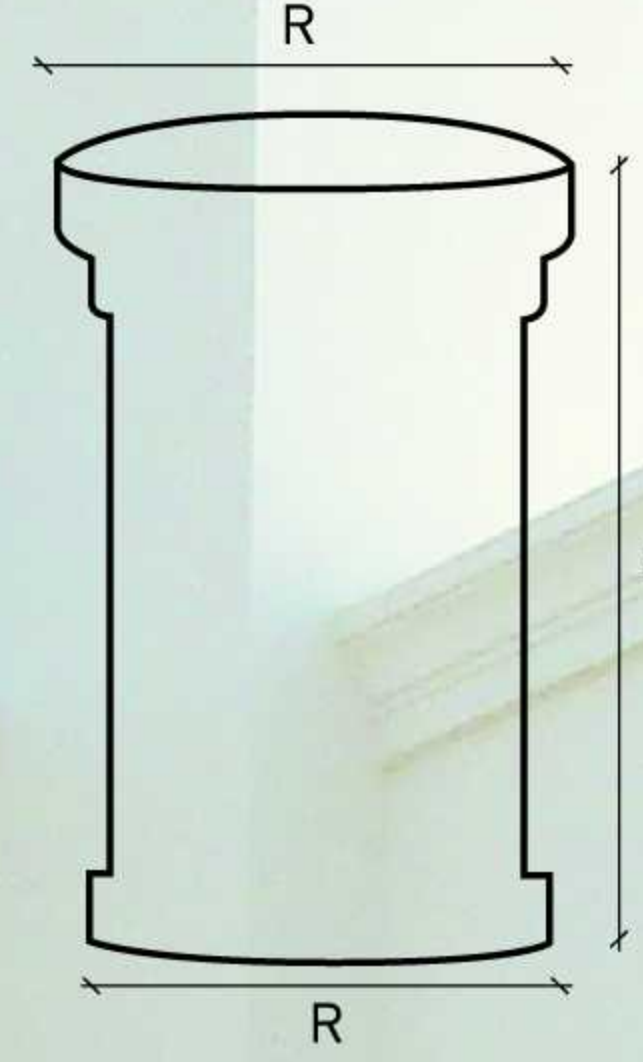

- D 012/20 A: 33cm B: 25cm C: 23cm D: 33cm
 D 012/30 A: 43cm B: 25cm C: 33cm D: 43cm
 D 012/40 A: 53cm B: 25cm C: 43cm D: 53cm
 D 012/50 A: 63cm B: 25cm C: 53cm D: 63cm

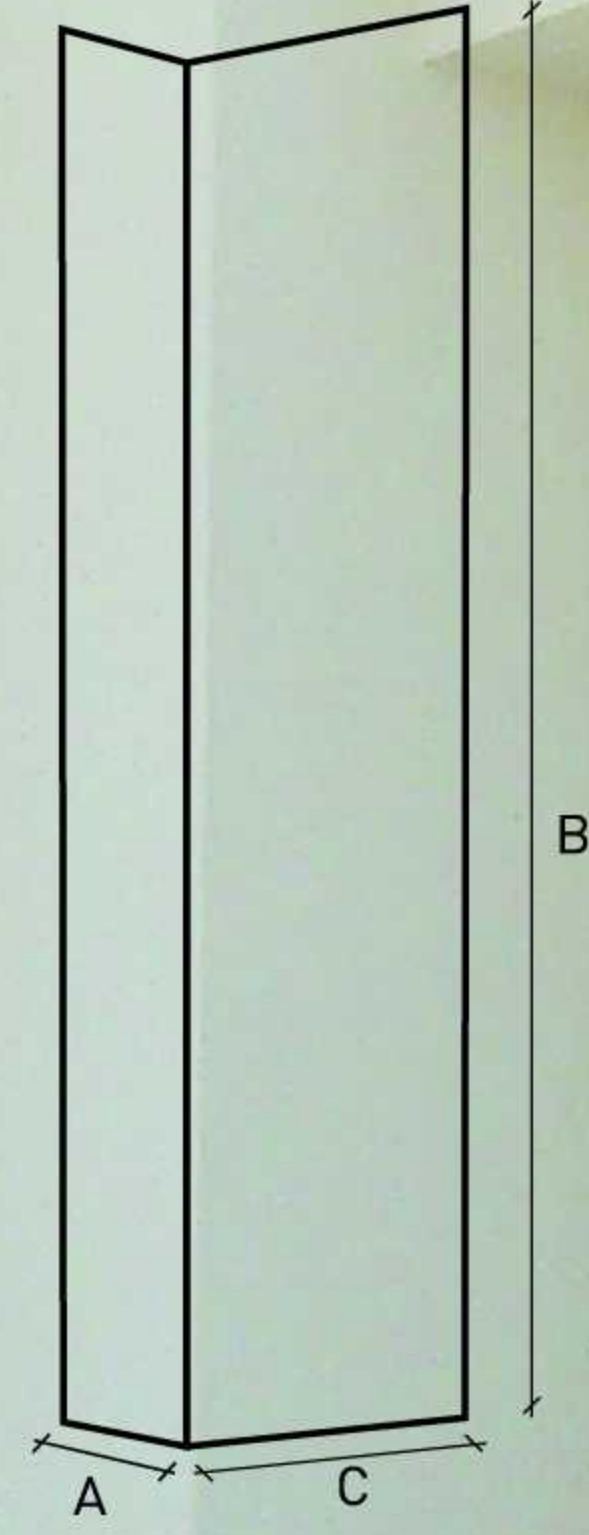

- S 021/20 A: 20cm B: 200cm C: 10cm
 S 021/30 A: 30cm B: 200cm C: 15cm
 S 021/40 A: 40cm B: 200cm C: 20cm
 S 021/50 A: 50cm B: 200cm C: 25cm



- D 011/20 A: 40cm B: 16cm C: 22cm D: 40cm
 D 011/30 A: 50cm B: 16cm C: 32cm D: 50cm
 D 011/40 A: 60cm B: 16cm C: 42cm D: 60cm
 D 011/50 A: 70cm B: 16cm C: 52cm D: 70cm



- D 005/20 R: 35cm B: 25cm R: 22cm
 D 005/30 R: 45cm B: 25cm R: 32cm
 D 005/40 R: 55cm B: 25cm R: 42cm
 D 005/50 R: 65cm B: 25cm R: 52cm

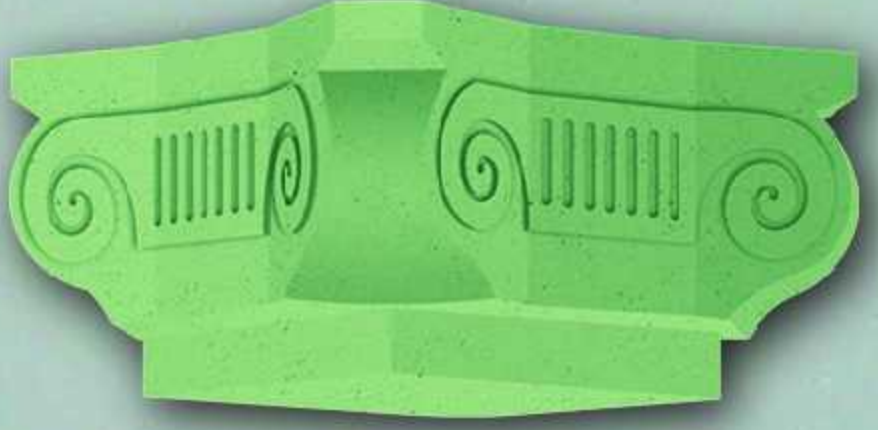

- D 010/20 A: 40cm B: 25cm C: 22cm D: 40cm
 D 010/30 A: 50cm B: 25cm C: 32cm D: 50cm
 D 010/40 A: 60cm B: 25cm C: 42cm D: 60cm
 D 010/50 A: 70cm B: 25cm C: 52cm D: 70cm



- S 022/20 A: 20cm B: 200cm C: 10cm
 S 022/30 A: 30cm B: 200cm C: 15cm
 S 022/40 A: 40cm B: 200cm C: 20cm
 S 022/50 A: 50cm B: 200cm C: 25cm



- D 009/20 R: 30cm B: 20cm R: 22cm
 D 009/30 R: 40cm B: 20cm R: 32cm
 D 009/40 R: 50cm B: 20cm R: 42cm
 D 009/50 R: 60cm B: 20cm R: 52cm

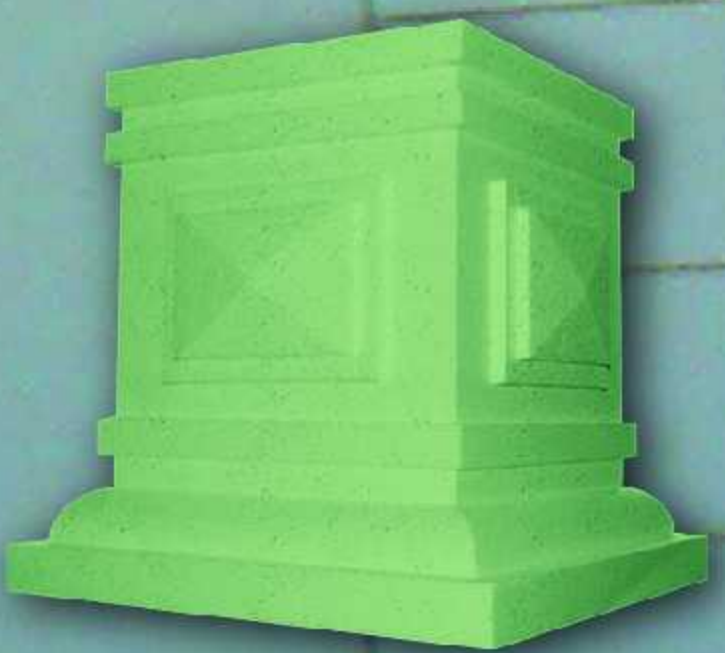

- D 014/20 A: 33cm B: 42cm C: 23cm D: 33cm
 D 014/30 A: 43cm B: 42cm C: 33cm D: 43cm
 D 014/40 A: 53cm B: 42cm C: 43cm D: 53cm
 D 014/50 A: 63cm B: 42cm C: 53cm D: 63cm

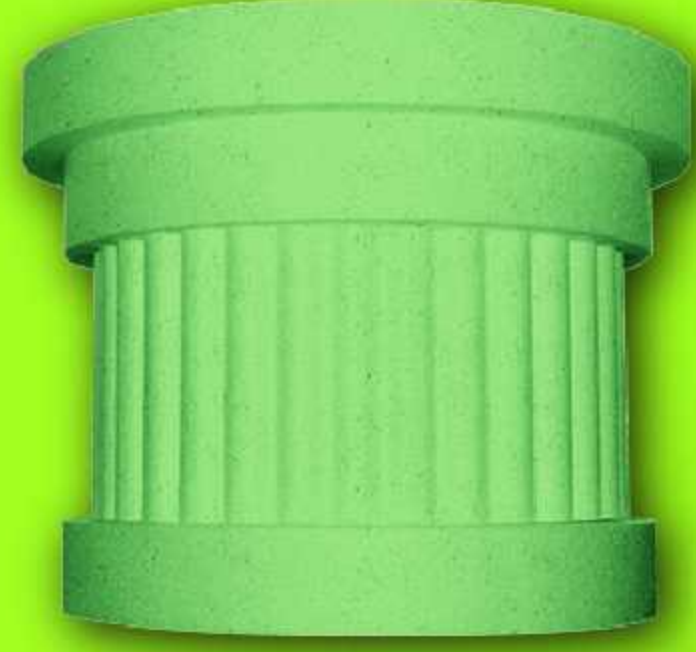

- D 016/20 R: 28cm B: 30cm R: 23cm
 D 016/30 R: 38cm B: 30cm R: 33cm
 D 016/40 R: 48cm B: 30cm R: 43cm
 D 016/50 R: 58cm B: 30cm R: 53cm



- D 001/20 R: 35cm B: 12cm R: 22cm
 D 001/30 R: 45cm B: 12cm R: 32cm
 D 001/40 R: 55cm B: 12cm R: 42cm
 D 001/50 R: 65cm B: 12cm R: 52cm

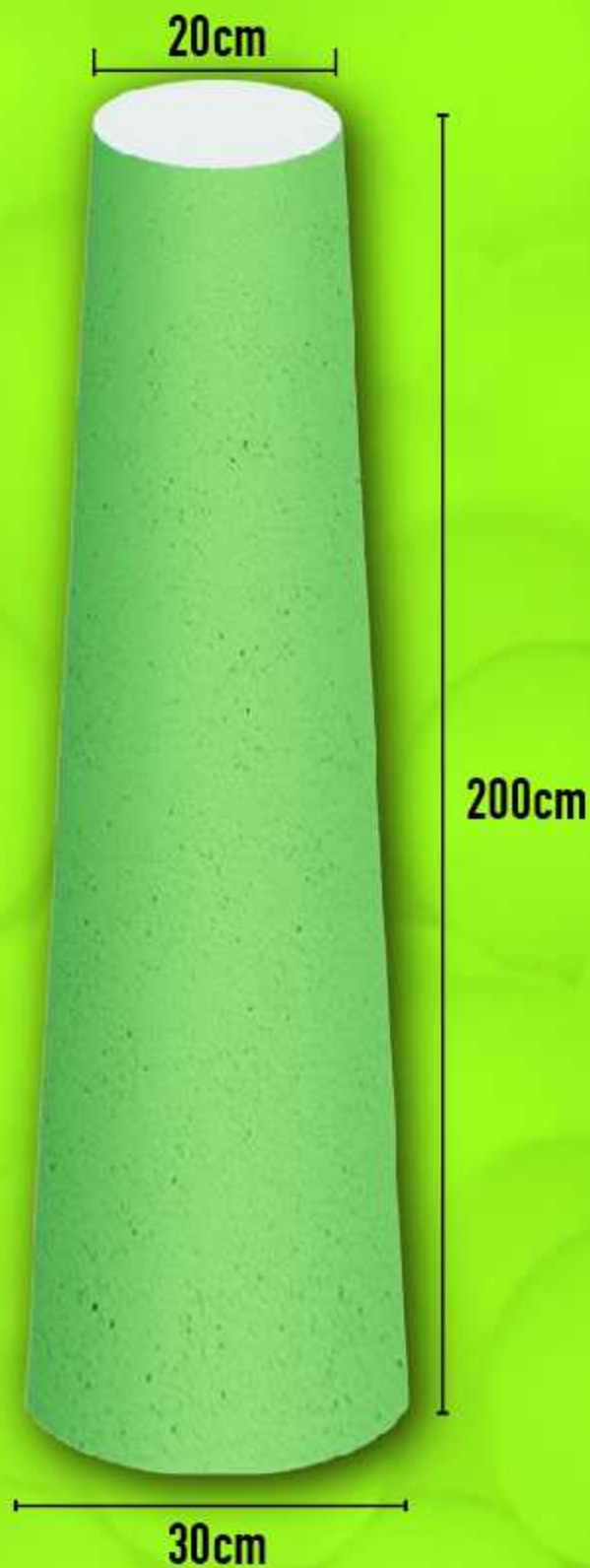

S 023/30



- D 004/20 R: 30cm B: 20cm R: 22cm
 D 004/30 R: 40cm B: 20cm R: 32cm
 D 004/40 R: 50cm B: 20cm R: 42cm
 D 004/50 R: 60cm B: 20cm R: 52cm



- D 013/20 A: 33cm B: 42cm C: 23cm D: 33cm
 D 013/30 A: 43cm B: 42cm C: 33cm D: 43cm
 D 013/40 A: 53cm B: 42cm C: 43cm D: 53cm
 D 013/50 A: 63cm B: 42cm C: 53cm D: 63cm



- D 015/20 A: 36cm B: 25cm C: 23cm D: 36cm
 D 015/30 A: 46cm B: 25cm C: 33cm D: 46cm
 D 015/40 A: 56cm B: 25cm C: 43cm D: 56cm
 D 015/50 A: 66cm B: 25cm C: 53cm D: 66cm



- S 024/20 A: 20cm B: 200cm C: 10cm
 S 024/30 A: 30cm B: 200cm C: 15cm
 S 024/40 A: 40cm B: 200cm C: 20cm
 S 024/50 A: 50cm B: 200cm C: 25cm

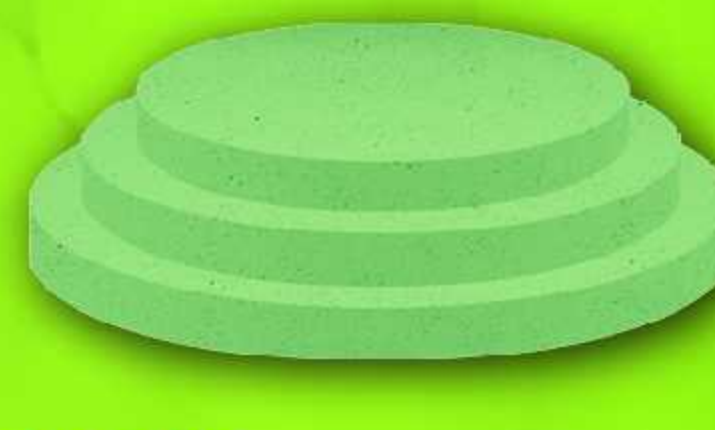

- D 017/20 R: 33cm B: 12cm R: 22cm
 D 017/30 R: 43cm B: 12cm R: 32cm
 D 017/40 R: 53cm B: 12cm R: 42cm
 D 017/50 R: 63cm B: 12cm R: 52cm

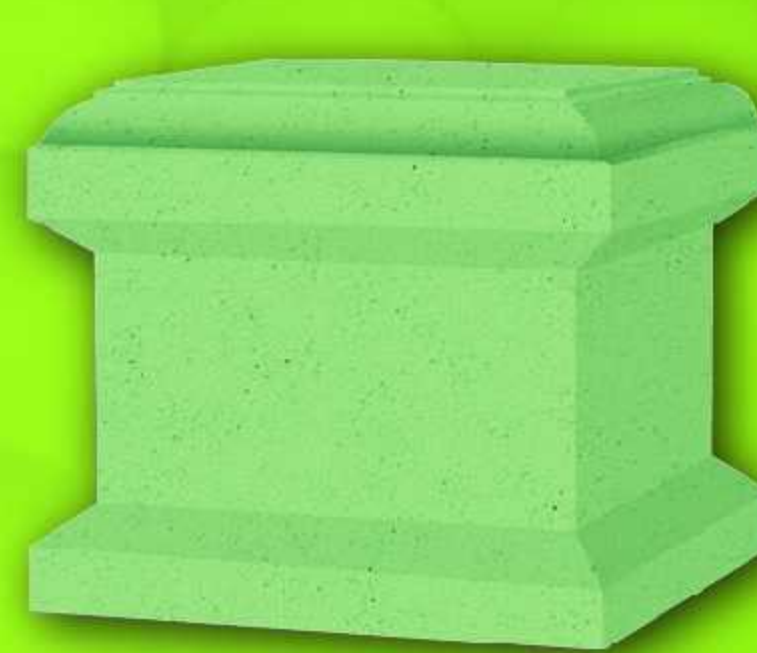

- D 006/20 A: 35cm B: 40cm C: 22cm D: 35cm
 D 006/30 A: 45cm B: 40cm C: 32cm D: 45cm
 D 006/40 A: 55cm B: 40cm C: 42cm D: 55cm
 D 006/50 A: 65cm B: 40cm C: 52cm D: 65cm



- D 002/20 A: 40cm B: 15cm C: 22cm D: 40cm
 D 002/30 A: 50cm B: 15cm C: 32cm D: 50cm
 D 002/40 A: 60cm B: 15cm C: 42cm D: 60cm
 D 002/50 A: 70cm B: 15cm C: 52cm D: 70cm



- D 007/20 R: 35cm B: 15cm R: 22cm
 D 007/30 R: 45cm B: 15cm R: 32cm
 D 007/40 R: 55cm B: 15cm R: 42cm
 D 007/50 R: 65cm B: 15cm R: 52cm



- S 025/20 A: 20cm B: 200cm C: 10cm
 S 025/30 A: 30cm B: 200cm C: 15cm
 S 025/40 A: 40cm B: 200cm C: 20cm
 S 025/50 A: 50cm B: 200cm C: 25cm



- D 008/20 A: 35cm B: 100cm C: 22cm D: 35cm
 D 008/30 A: 45cm B: 100cm C: 32cm D: 45cm
 D 008/40 A: 55cm B: 100cm C: 42cm D: 55cm
 D 008/50 A: 65cm B: 100cm C: 52cm D: 65cm

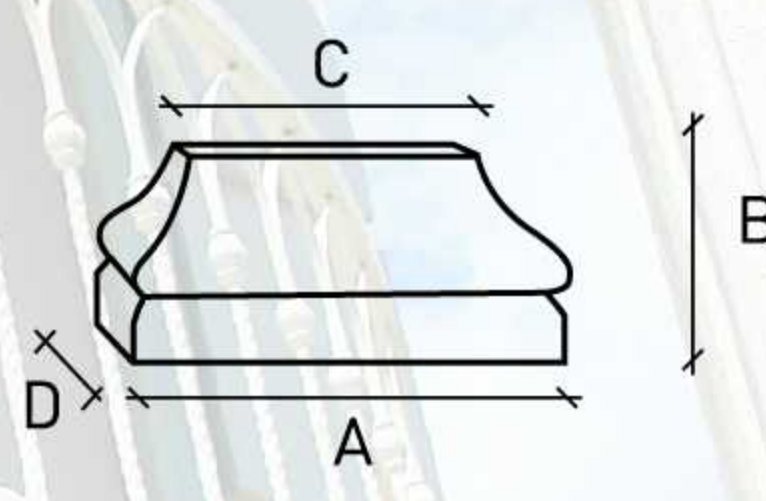
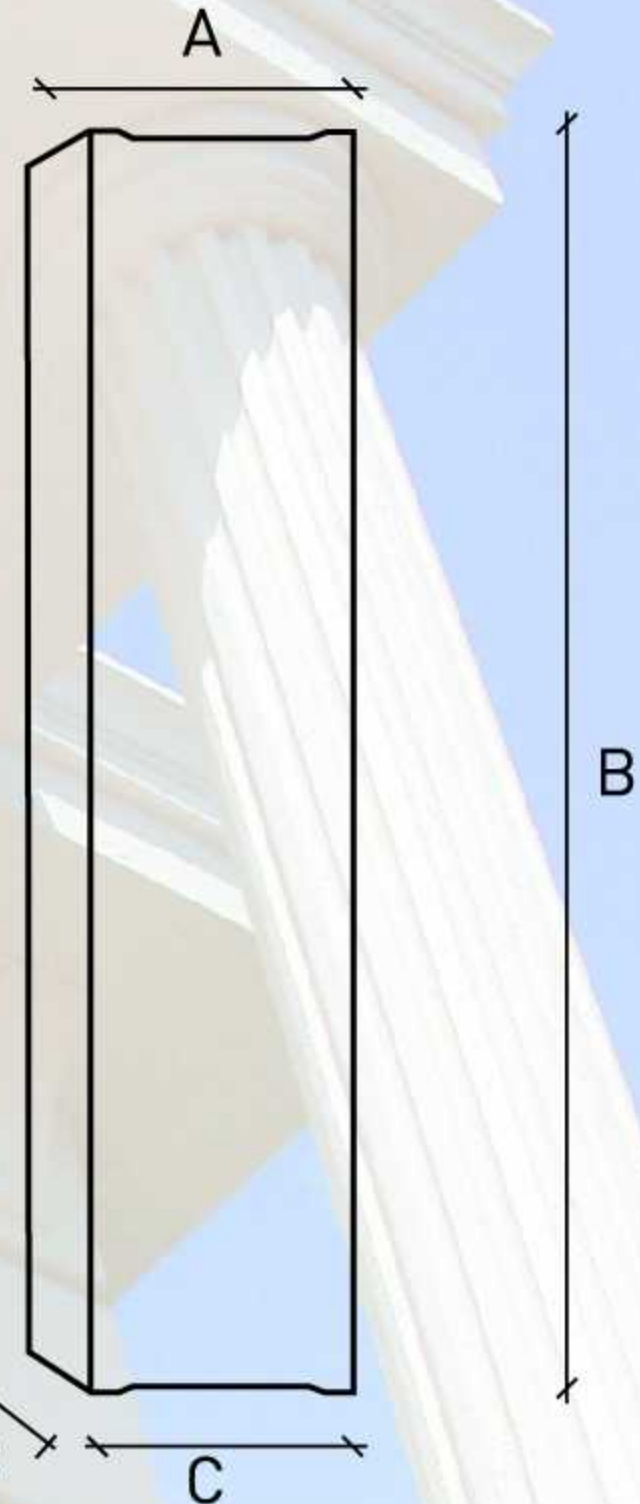
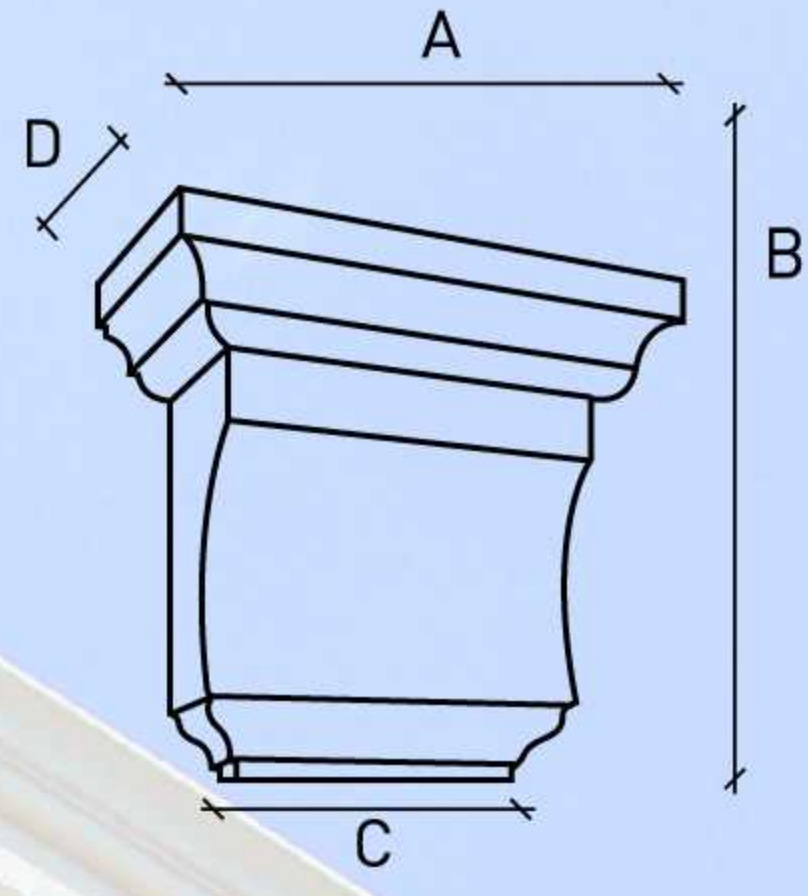
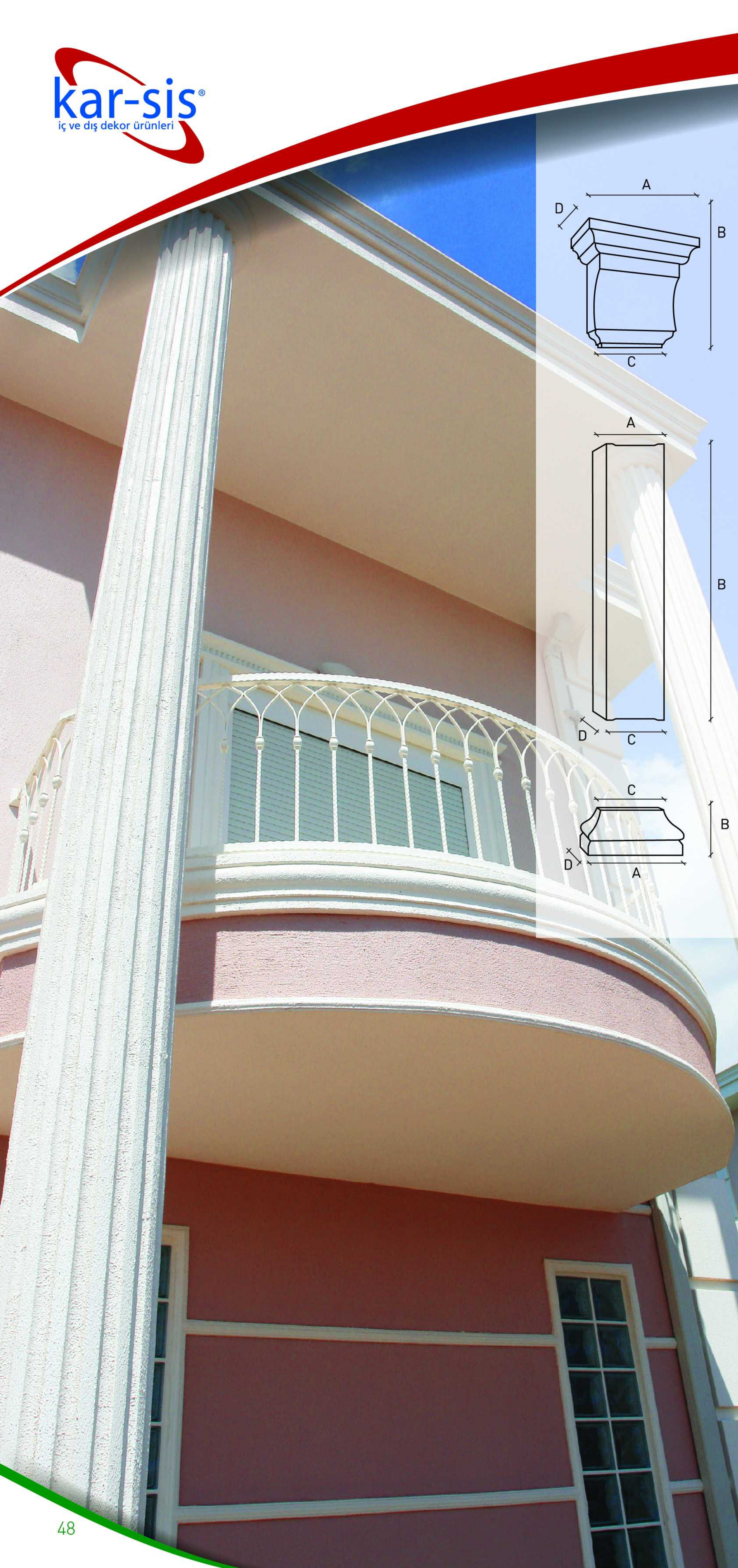

B 06
A: 30cm B: 20cm
C: 23cm D: 11cm



B 05
A: 27cm B: 29cm
C: 23cm D: 10cm



DIŞ 151
A: 20cm B: 200cm
C: 20cm D: 3cm

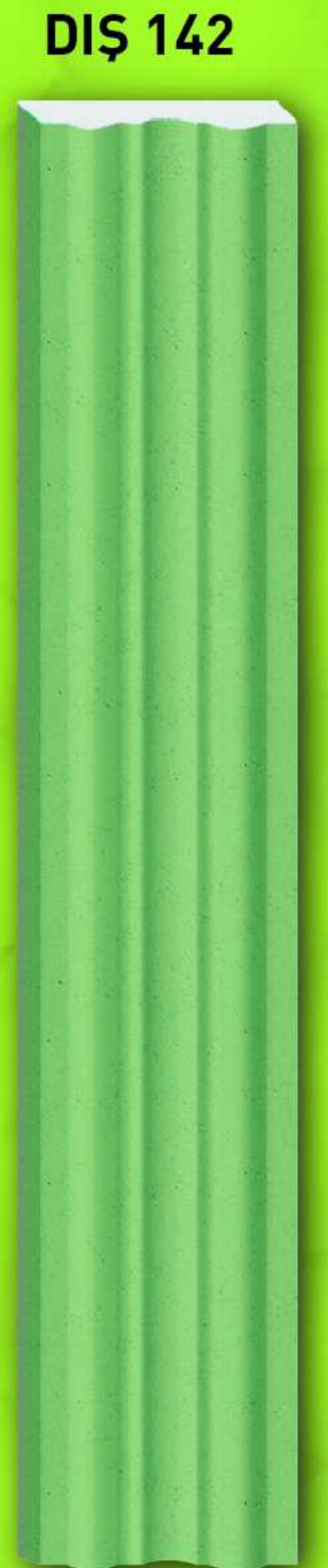

DIŞ 142
A: 20cm B: 200cm
C: 20cm D: 4cm

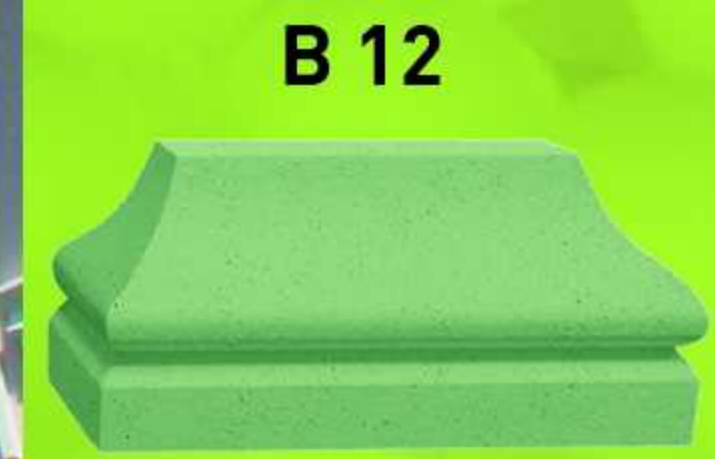

B 12
A: 37cm B: 15cm
C: 23cm D: 12cm



B 11
A: 33cm B: 25cm
C: 23cm D: 10cm

KABARTMA SÜTUN VE KAİDELER

Embossed Columns and Pedestals

B 01



A: 27cm B: 57cm
C: 23cm D: 8cm

B 02



A: 32cm B: 35cm
C: 23cm D: 9cm

B 03



A: 37cm B: 30cm
C: 23cm D: 14cm

B 04



A: 37cm B: 23cm
C: 23cm D: 13cm

DES 020



A: 20cm B: 200cm
C: 20cm D: 5cm

DES 021



A: 20cm B: 200cm
C: 20cm D: 5cm

DIŞ 144



A: 20cm B: 200cm
C: 20cm D: 4cm

DIŞ 143

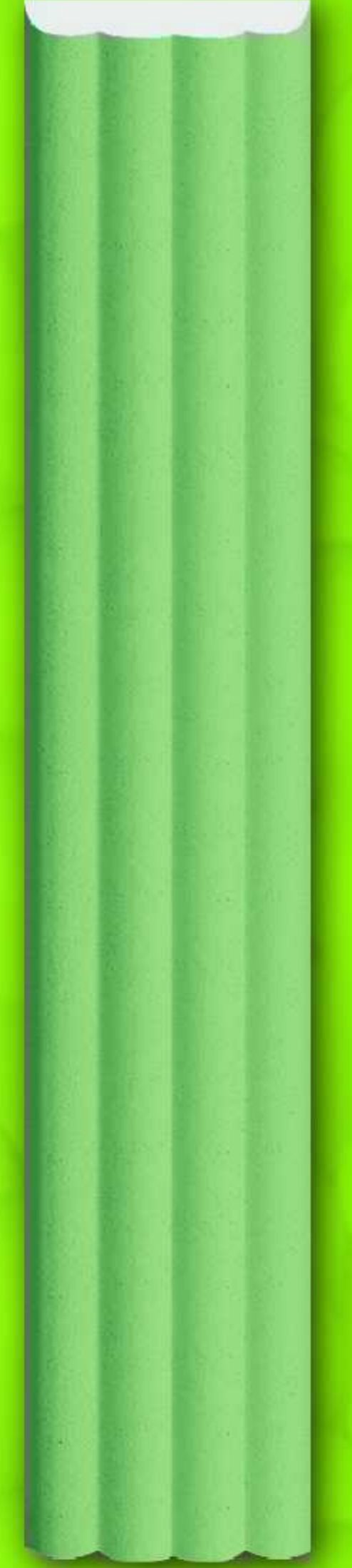

A: 20cm B: 200cm
C: 20cm D: 4cm

B 08



A: 33cm B: 41cm
C: 23cm D: 10cm

B 07

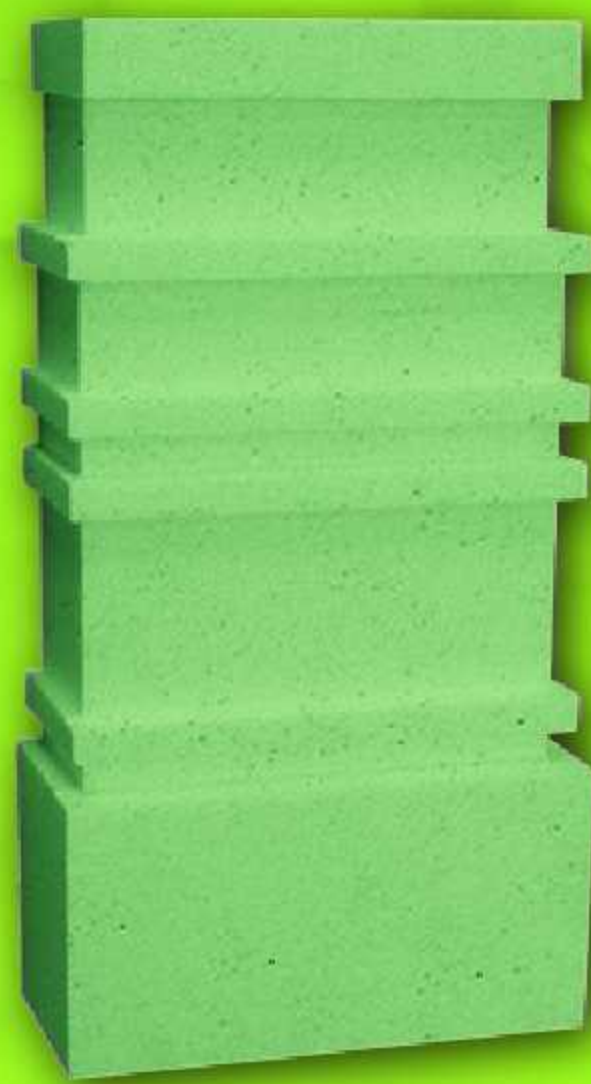

A: 26cm B: 50cm
C: 23cm D: 8cm

B 09



A: 33cm B: 40cm
C: 23cm D: 10cm

B 10



A: 39cm B: 31cm
C: 23cm D: 14cm

DIŞ DEKOR UYGULAMA TEKNİKLERİ

Exterior Decoration Application Techniques

DIŞ CEPHE KAPLAMALARI Exterior Sidings



1

- Uygulama yüzeyinin öncelikli zemin etüdü yapılır.
- Yüzey teraziye alınarak zemin işaretlenmelidir.

The ground studies of application surface is done.

Application surface should be balanced and marked.



2

- Polistren yapıştırıcı, 25kg/6lt oranında su ile mikser yardımıyla homojen hale gelinceye kadar karıştırılır.

The polystyrene adhesive is mixed in 25kg/6 l. water until it is homogenous.

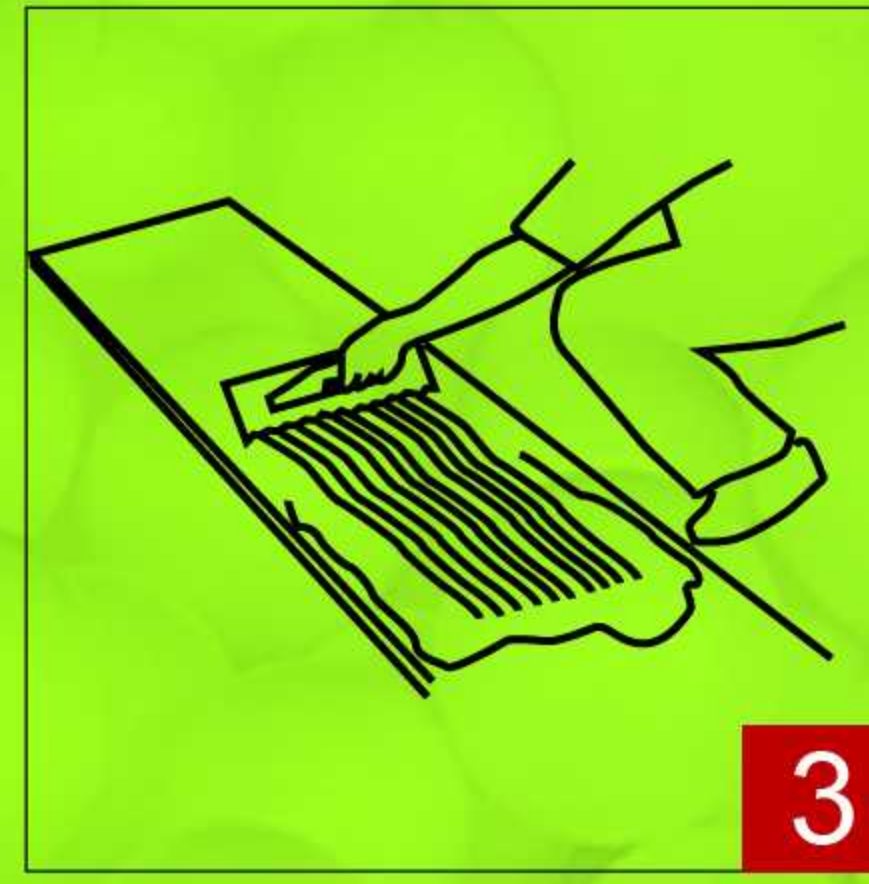

3

- Hazırlanan yapıştırıcı, tırmıklı mala ile malzemenin yüzeyine eşit olarak sürülmelidir.

Prepared adhesive should be applied on the surface of the material equally by a notched trowel.



4

- Malzeme, daha önceden teraziye alınmış ve işaretlenmiş yüzey üzerinde sağa sola kaydırılarak yerleştirilir.

The material should be placed on the previously balanced and marked surface by moving rightwards and leftwards.

DEKOR PROFİLLERİ Decoration Profiles



1

- Denizlikten başlayarak, pencere ölçüleri alınır ve ardından gönye kesimleri hazırlanır.

The mitre sections should be prepared by taking the measurements of the window firstly beginning from the windowsill.



2

- Polistren yapıştırıcı, 25kg/6lt oranında su ile mikser yardımıyla homojen hale gelinceye kadar karıştırılır.

The polystyrene adhesive is mixed in 25kg/6 l. water until it is homogenous.



3

- Malzemenin duvara gelecek kısmına, yapıştırıcı spatula yardımıyla sürülür.
- Birleşim yerlerine sürülen yapıştırma harcı, ağız ağıza geldiğinde mutlaka dışarı taşırılır.

The adhesive is applied on surface facing the wall by a spatula. Mortar should be applied on the joints and the adhesive should be effused from the joints by a notched trowel.

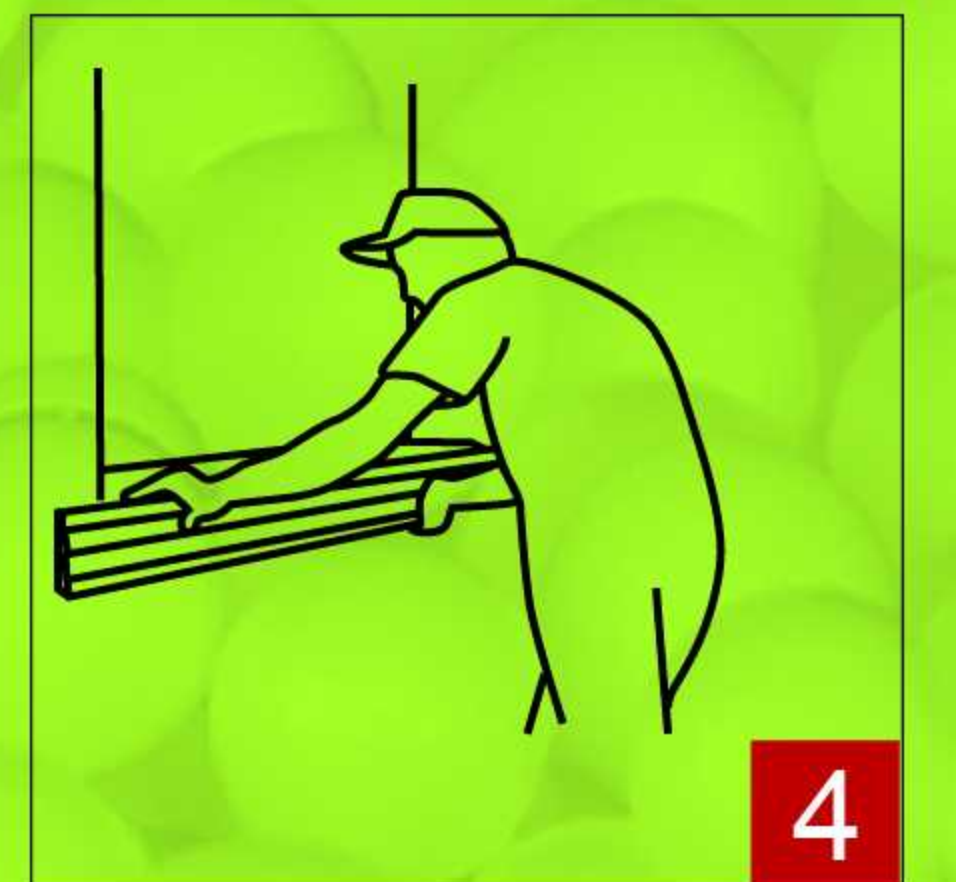

4

- Montajdan önce zemin etüdü mutlaka gerçekleştirilir ve yüzey boyalı ise çentesi yapılır.
 - Malzemenin, kaydırılarak yerine montajı sağlanır.
- Daha önceden terazisi alınmış ve işaretlenmiş yüzeye malzeme tatbik edilir.

The ground studies should be done before mounting and if the surface is painted, it should be notched. The material should be mounted by moving right and left. The material is applied on the pre-balanced and premarked surface.

DIŞ DEKOR UYGULAMA TEKNİKLERİ

Exterior Decoration Application Techniques

DIŞ DEKOR YARDIMCI ÜRÜNLER

Auxiliary Products of Exterior Decoration



KARPLAST
Polistren Sıvası
Polystyrene Mortar



KARFİX
Polistren Yapıştırıcısı
Polystyrene Adhesive



Ek Yeri Tamir Harcı
Joining Surface Mortar



Paltolama Köpüğü
Insulation Panels Foam



Poliüretan Tabancası
Polyurethane Gun



Kesim Aparatı
Cutting Apparatus

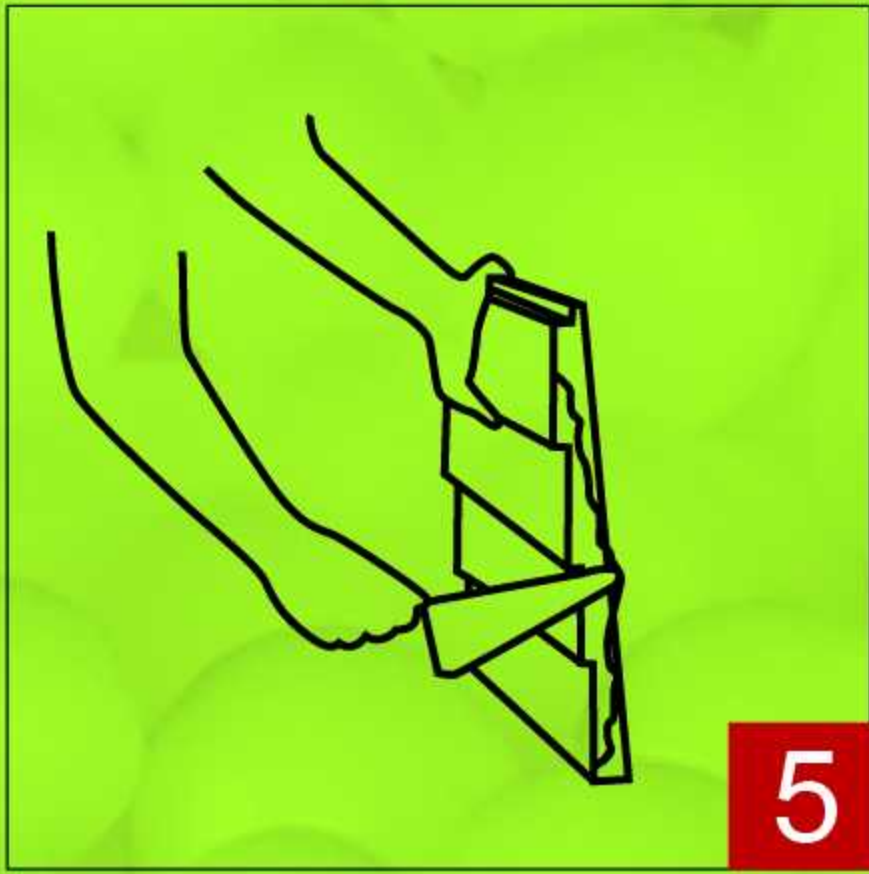

5

- İkinci parçaya yapıştırıcı sürülürken, ek yerine gelecek kısma da harç sürülür.

While applying adhesive on the second part, it should not be forgotten to apply adhesive on the joint.

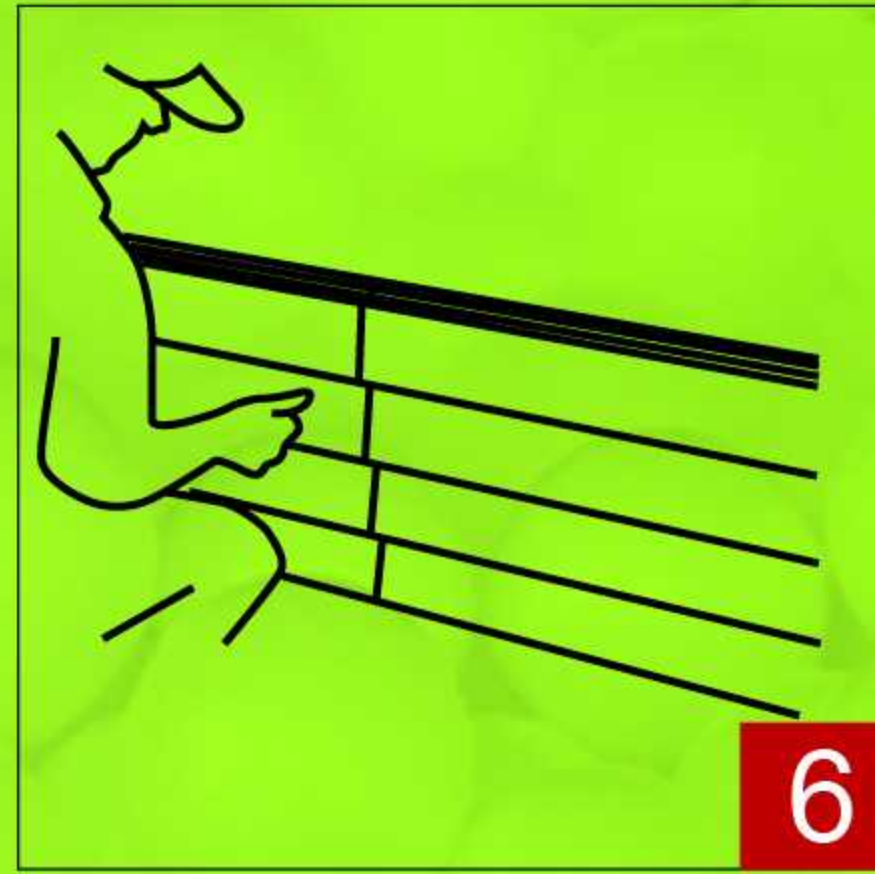

6

- İkinci parçanın montajı yapılırken, modüllerin hizasına dikkat edilerek ek yerindeki yapıştırıcının taşması sağlanır.

The alignment of the modules should be considered while assembling the second part. The adhesive should be effused from the joints.

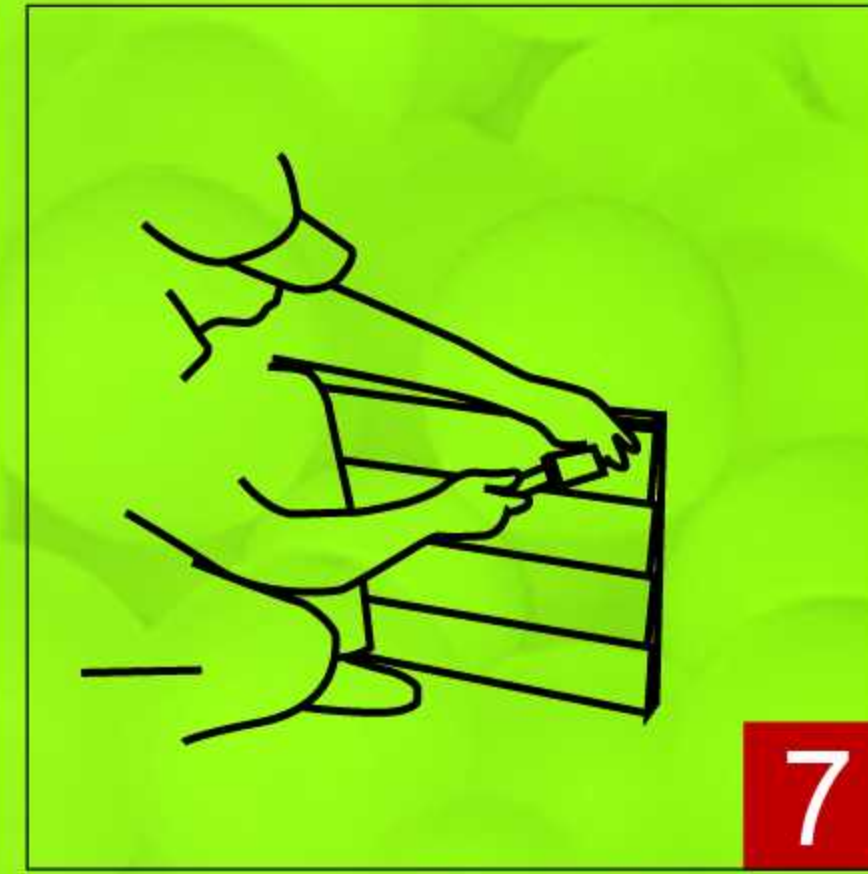

7

- Yapıştırıcı prizini alana kadar, ilk kademe ürünlere, çivi ya da dübel takviyesi uygulanır.

Until settling of the adhesive is completed, the nail or peg support should be applied on the first stage products.

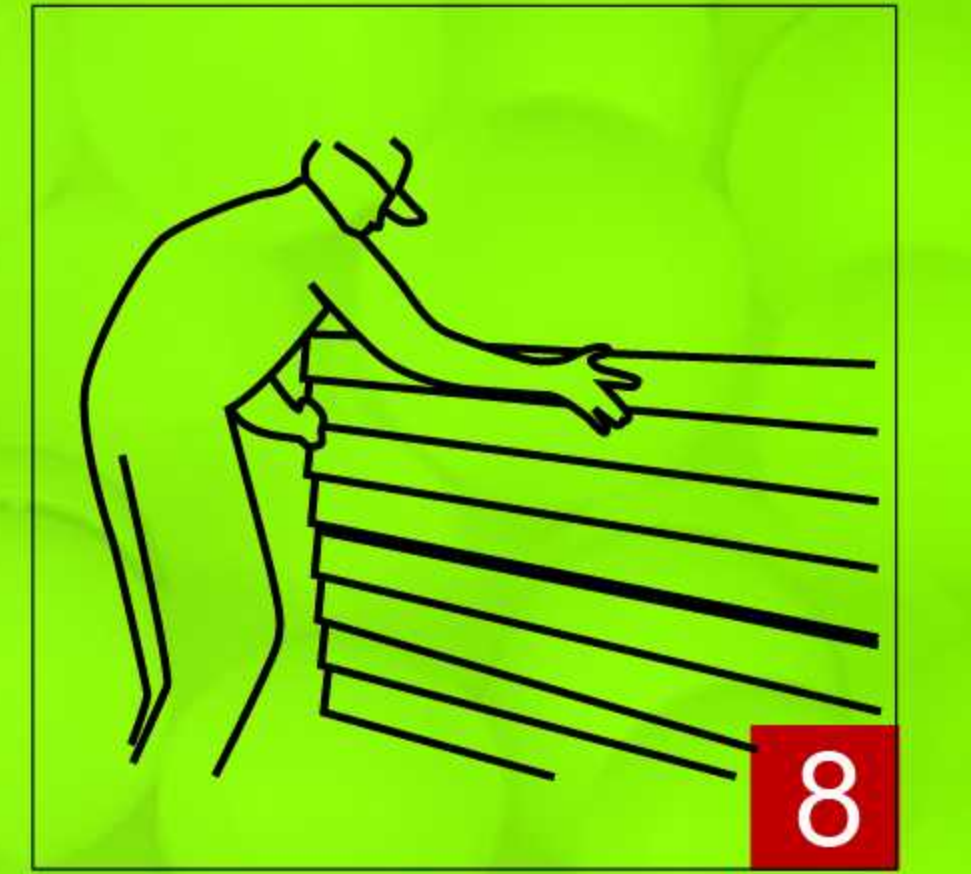

8

- Şaşırtma yöntemiyle, üst plakalar alt plakaların ek yerlerini ortalayacak şekilde, uygulamaya devam edilir.
- Spatula yardımıyla yapılan rötuşlar, 4-5 saat sonra tekrar elden geçirilerek dış cephe kaplama işlemi sonlandırılır.

The application should be continued in order the upper plates center the joints of the lower ones by confusion method. The finishing should be done by a spatula and refinished after 4-5 hours.



5

- Yapıştırıcının geç donmasından dolayı, malzeme beton çivisiyle sabitlenir.

The material should be fixed by a concrete nail, because the adhesive petrifies late.

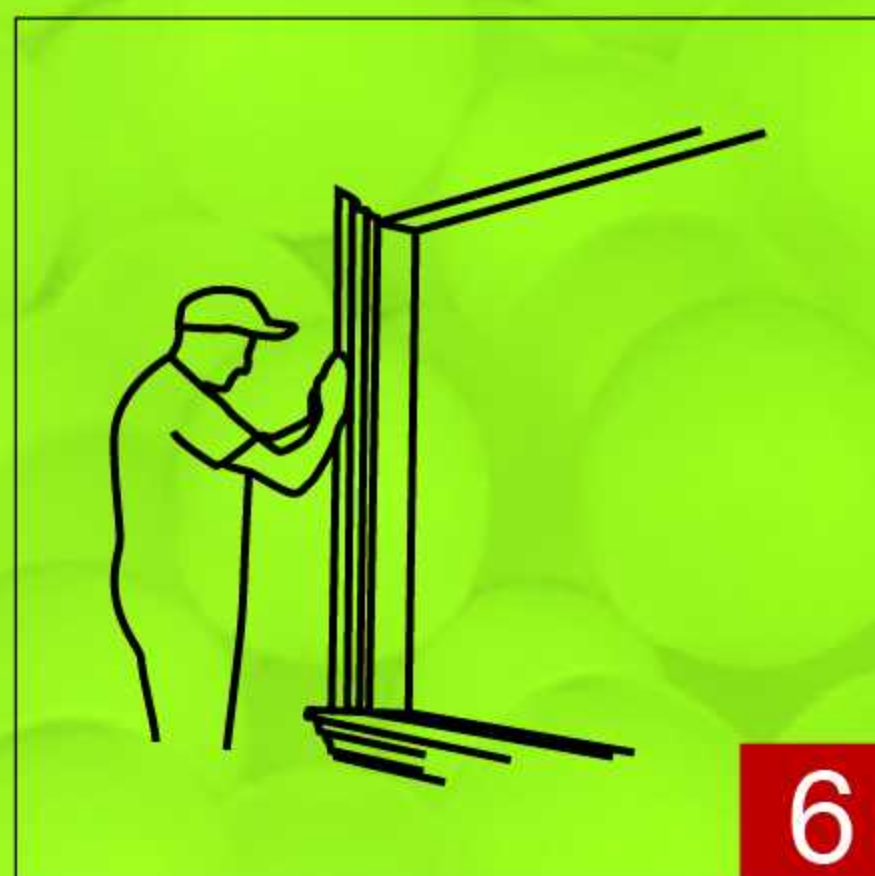

6

- Yan söveler, sağa sola oynatarak yerine montaj edilir.
- Ağız ağıza gelen kısımlarda, yapıştırıcı dışarı taşırılır.

Side frames should be mounted by moving right and left. The adhesive should be effused at the joints.

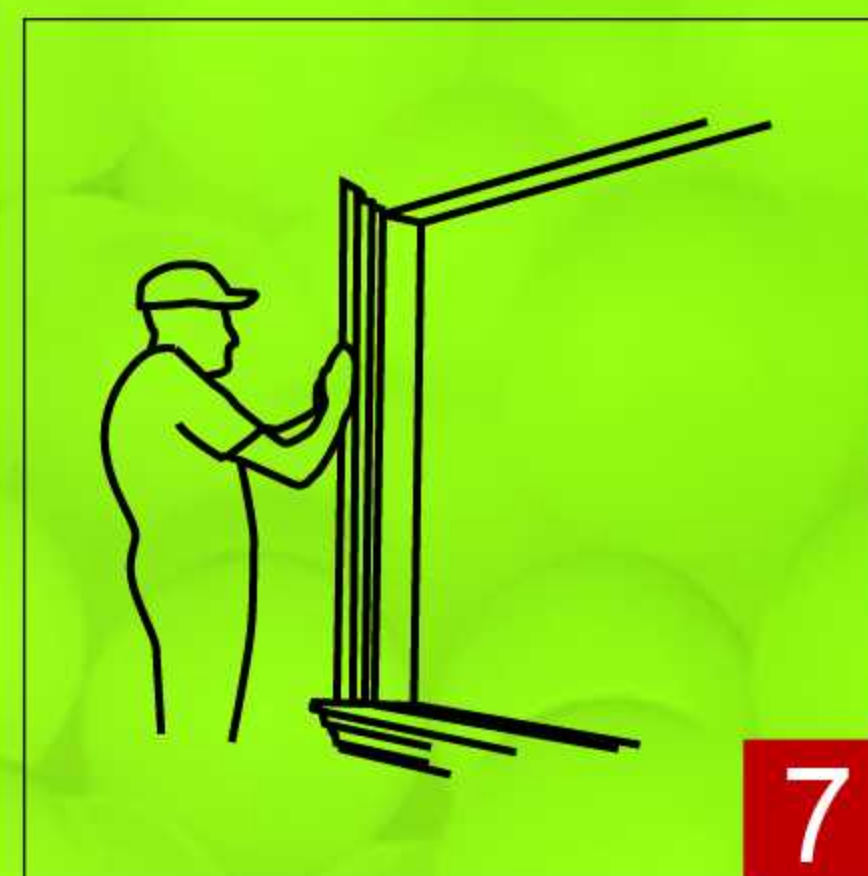

7

- Ürün montajından hemen sonra, teraziye alınır.

The product should be balanced just after mounting.

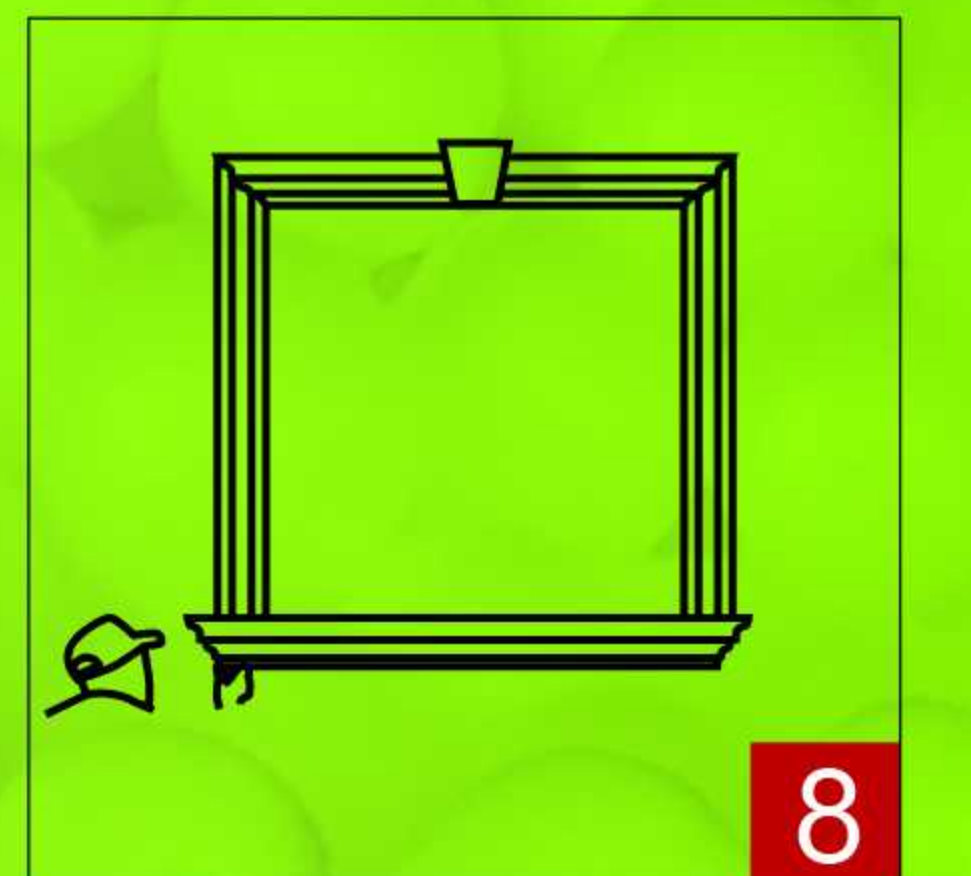

8

- Spatula ve çelik yardımıyla, harç temizlenir.
- Ortalama 4-5 saat sonra, zımpara ile rötuşu yapılır.

The mortar should be cleaned by a spatula or a steel piece. It should be finished by an emery approximately after 4-5 hours.

EPS İZOLASYON VE AMBALAJ ÜRÜNLERİ

Eps insulation and packaging products

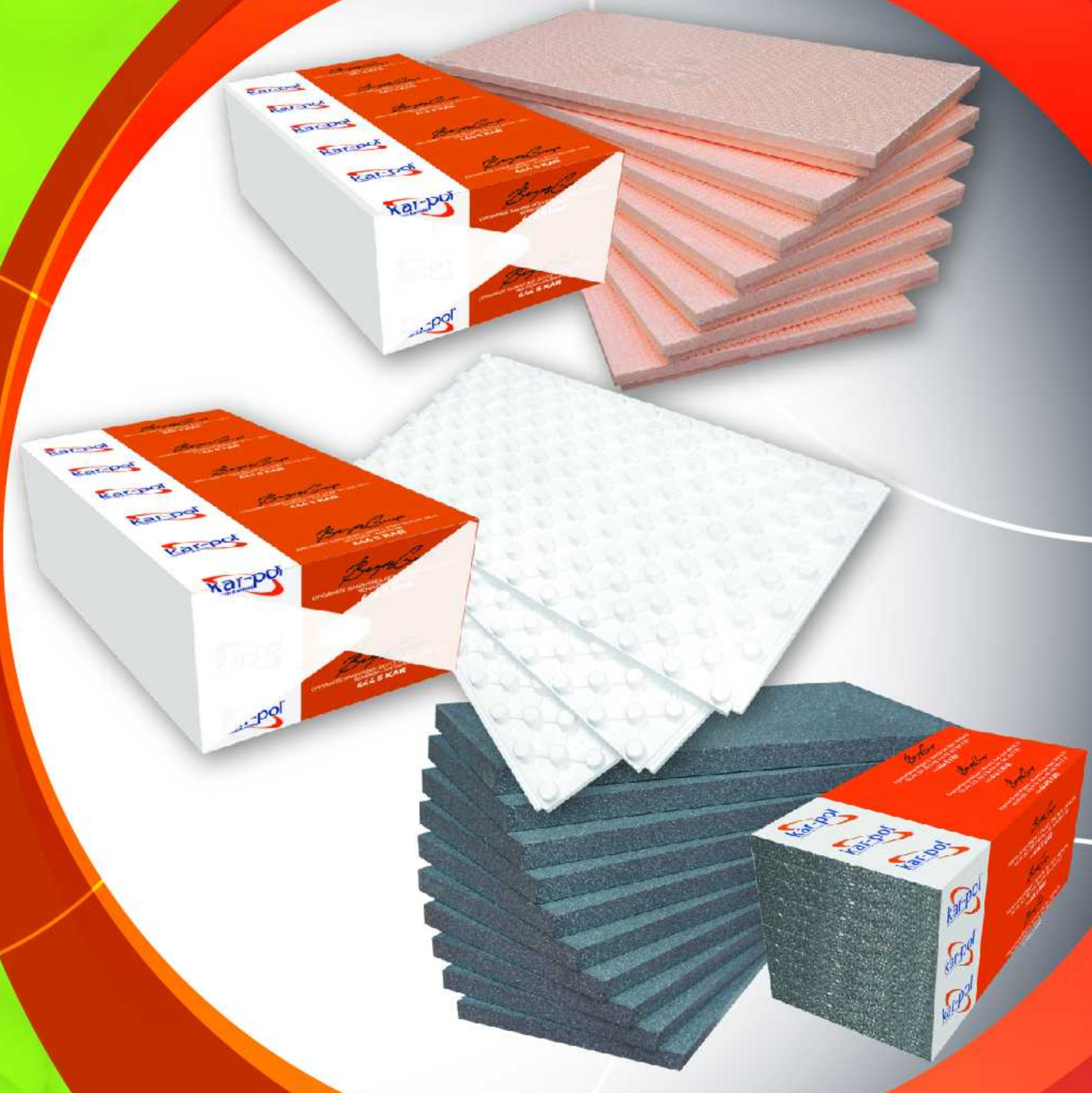



Kar-pol 2006 yılında Antalya Organize Sanayi Bölgesinde faaliyete geçerek 66.500m² alanda yıllık 15.000ton EPS polistren işleme kapasitesine ulaşmış ve her geçen gün ürün yelpazesine yeni ürünler ilave etmektedir. Blok ve enjeksiyon makineleri ile; inşaatın başlangıcından ince dekor işlerine kadar her aşamasında kullanılan izolasyon ve dekorasyon malzemelerinin yanısıra çeşitli ambalaj ürünleri ve fidecilikte kullanılan fide kapları (viyol) ile de bir çok sektörün ihtiyacına cevap verebilmektedir. Firma, müşteri odaklı kurumsal kimliğini, teknolojiye dayalı üretim sistemi ile birleştirerek, yükselen çizgisini korumaya devam etmektedir.



Kar-Pol launched producing in 2006 in Antalya Intustrial zone with 66.500m²sqm area. Annual EPS polystyrene manufacturing capacity has reached 15.000 tones and product range is developed with new pieces every passing day. Kar-Pol responds the need of variety of sectors with its various packaging products and seed trays (viyol), besides insulation and decoration products which are used in every stage of construction from the beginning to details with the machines of block and injection. The firm continues to maintain its raising trend line by combining its customer focused corporate identity with sophisticated manufacturing system.

KAR-PANEL / POLISTREN PANEL

Polystyrene Panel



Kar-Panel ürünleri, B1 sınıfı alev yürümeyen hammaddeden üretilmektedir. Standart paketler dışında 100x100x400cm ve 100x120x400cm Kar-Panel bloklardan istenilen ebat ve yoğunlukta kesilerek özel üretimde yapılmaktadır.

Kar-Panel products are manufactured from B1 Class nonflammable raw-material. They can be manufactured at any demanded sizes and densities by cutting from 100x100x400 cm and 100x120x400 cm blocks.

ÜRÜN ÖLÇÜSÜ Product Dimension	PAKET / Adet Package / Piece	PAKET / m ² Package / m ²
1x50x100cm	50 Adet /piece	25.00m ²
2x50x100cm	25 Adet /piece	12.50m ²
3x50x100cm	16 Adet /piece	8.00m ²
4x50x100cm	12 Adet /piece	6.00m ²
5x50x100cm	10 Adet /piece	5.00m ²
6x50x100cm	8 Adet /piece	4.00m ²
7x50x100cm	7 Adet /piece	3.50m ²
8x50x100cm	6 Adet /piece	3.00m ²
9x50x100cm	5 Adet /piece	2.50m ²
10x50x100cm	5 Adet /piece	2.50m ²

KAR-PANEL DENEY SONUÇLARI (KAR-PANEL TEST RESULT)

ÜRÜN CİNSİ (DESCRIPTION)	TS EN 826 %10 BASMA DAYANIMI TS EN 826 %10 COMPRESSION STRENGTH		TS EN 1603 SABİT LABARATUAR ORTAMINDA BOYUT KALINLIĞI		TS EN 12667 ISIL DİRENÇ VE ISIL İLETKENLİK TS EN 12667 THERMAL RESISTANCE AND THERMAL CONDUCTIVITY		TS EN ISO 11925-2 YANGINA TEPKİ
			TS EN 1603 DIMENSIONAL STABILITY UNDER CONSTANT LABORATORY		ISIL DİRENÇ THERMAL RESISTANCE	ISIL İLETKENLİK THERMAL CONDUCTIVITY	TS EN ISO 11925-2 REACTION TO FIRE
			GENLİKTE IN WIDTH	UZUNLUKTA IN LENGTH			
kar-panel 16 kg/m ³	322,42 N	82,93 kPa	-0,1	-0,1	1,400464 m ² K/W	0,037291 W/mk	E
kar-panel 20 kg/m ³	454,74 N	113,23 kPa	0	0	1,422181 m ² K/W	0,034737 W/mk	E
kar-panel 26 kg/m ³	653,80 N	163,73 kPa	0	0	1,475646 m ² K/W	0,034181 W/mk	E
kar-panel 30 kg/m ³	762,79 N	196,80 kPa	0	0	1,512302 m ² K/W	0,033496 W/mk	E

KAR-NEOPANEL / KARBON TAKVİYELİ PANEL

Carbonaceous Panel

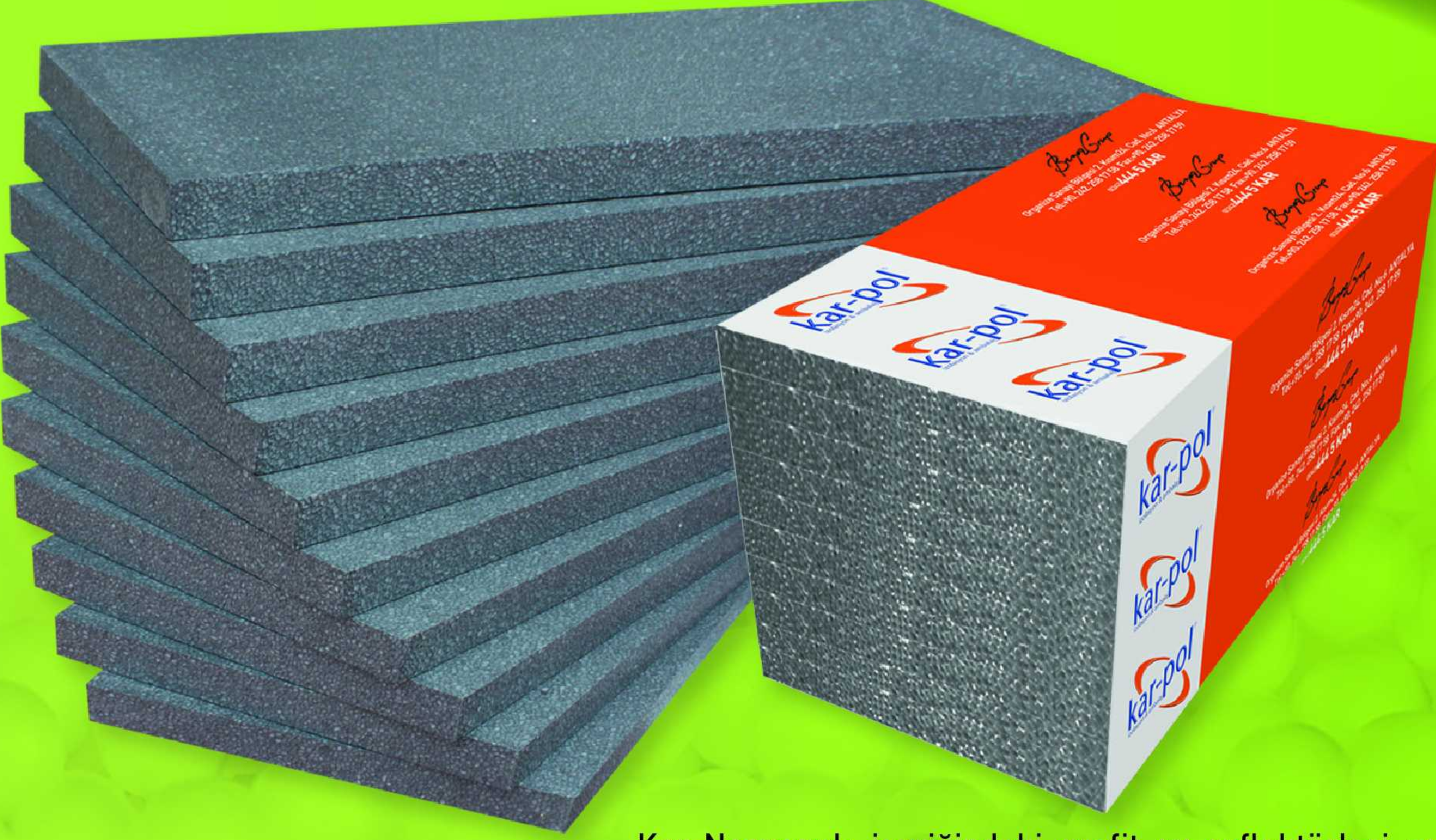

Kar-Neopanel; içeriğindeki grafit ısı reflektörleri sayesinde yalıtım özelliği geliştirilmiş, gri renkli yeni nesil ısı yalıtım malzemesidir. Malzemeye gri rengi grafit ısı reflektörleri verir. Grafit; hem sıcakı hem soğuyu daha iyi yansıtarak, malzemenin ısı yalıtım özelliğinin EPS'ye göre daha iyi olmasını sağlar. Kar-Neopanel istenilen ebat ve yoğunluklarda bloktan kesilerek üretilmektedir. Normal EPS'nin 16 kg/m^3 'de ısı iletkenlik katsayısı $0,037 \text{ w/(mk)}$ iken, Kar-Neopanel'in ısı iletkenlik katsayısı $0,032 \text{ w/(mk)}$ 'dir. Bu yüzden söz konusu yalıtım olduğunda Kar-Neopanel diğer ürünlere göre daha özellikli bir malzemedir.

Kar-Neopanel is the grey colored new generation thermal insulation material with increased insulation characteristics through embedded graphite thermal reflectors. The graphite thermal reflectors give its grey color to the material. Graphite ensures that the thermal insulation of the product is better than EPS by reflecting hot and cold better. Kar-Neopanel is manufactured by cutting from blocks at demanded size and densities. While the thermal conductivity factor of normal EPS is $0,037 \text{ w/(mk)}$, Kar-Neopanel's is $0,032 \text{ w/(mk)}$. Therefore, Kar-Neopanel is a more special product than the others when insulation is considered.

ÜRÜN ÖLÇÜSÜ Product Dimension	PAKET / Adet Package / Piece	PAKET / m ² Package / m ²
2x50x100cm	25 Adet /piece	12.50m ²
3x50x100cm	16 Adet /piece	8.00m ²
4x50x100cm	12 Adet /piece	6.00m ²
5x50x100cm	10 Adet /piece	5.00m ²
6x50x100cm	8 Adet /piece	4.00m ²
7x50x100cm	7 Adet /piece	3.50m ²
8x50x100cm	6 Adet /piece	3.00m ²
9x50x100cm	5 Adet /piece	2.50m ²
10x50x100cm	5 Adet /piece	2.50m ²

KAR-NEOPANEL DENEY SONUÇLARI (KARNEO-PANEL TEST RESULT)

ÜRÜN CİNSİ (DESCRIPTION)	TS EN 826 %10 BASMA DAYANIMI TS EN 826 %10 COMPRESSION STRENGTH		TS EN 1603 SABİT LABARATUAR ORTAMINDA BOYUT KALINLIĞI		TS EN 12667 ISIL DİRENÇ VE ISIL İLETKENLİK TS EN 12667 THERMAL RESISTANCE AND THERMAL CONDUCTIVI		TS EN ISO 11925-2 YANGINA TEPKİ
			TS EN 1603 DIMENSIONAL STABILITY UNDER CONSTANT LABORATORY		ISIL DİRENÇ THERMAL RESISTANCE	ISIL İLETKENLİK THERMAL CONDUCTIVITY	TS EN ISO 11925-2 REACTION TO FIRE
			GENLİKTE IN WIDTH	UZUNLUKTA IN LENGTH			
kar-neopanel 16 kg/m^3	324,02 N	83,67 kPa	0	0	1,564852 m ² K/W	0,031410 W/mk	E
kar-neopanel 20 kg/m^3	642,74 N	154,50 kPa	-0,1	-0,1	1,637352 m ² K/W	0,030590 W/mk	E

KAR-BOARD / POLİSTREN BOARD

Polystyrene Board



EPS POLİSTREN BOARD plakalar enjeksiyon makineleri ile kalıplı sistemle 16kg/dansite ile 30kg/dansite arasında üretilir. Kalınlıkları 2 cm ile 8 cm arasında olup, 60cm x 120cm ebatlarında binili ürünlerdir. Isı yalıtımında verimliliği oldukça yüksek ve ekonomik bir üründür. Kesinlikle sağlığa zararlı bir ürün değildir.

EPS POLYSTYRENE BOARD plates are manufactured by injection machines in a molded system at 16kg/density and 30 kg/density range. The thickness is in between 2cm and 8cm and they are 60cmx120cm built in products. It is an economic product with extremely high thermal insulation. It is not an unhealthy product.

ÜRÜN ÖLÇÜSÜ Product Dimension	PAKET / Adet Package / Piece	PAKET / m ² Package / m ²
02x60x120 cm	16 Adet /piece	11,52 m ²
03x60x120 cm	13 Adet /piece	9,36 m ²
04x60x120 cm	8 Adet /piece	5,76 m ²
05x60x120 cm	7 Adet /piece	5,04 m ²
06x60x120 cm	6 Adet /piece	4,32 m ²
07x60x120 cm	5 Adet /piece	3,60 m ²
08x60x120 cm	4 Adet /piece	2,88 m ²

KAR-BOARD DENEY SONUÇLARI (KAR-PANEL TEST RESULT)

ÜRÜN CİNSİ (DESCRIPTION)	TS EN 826 %10 BASMA DAYANIMI TS EN 826 %10 COMPRESSION STRENGTH		TS EN 1603 SABİT LABARATUAR ORTAMINDA BOYUT KALINLIĞI		TS EN 12667 ISIL DİRENÇ VE ISIL İLETKENLİK TS EN 12667 THERMAL RESISTANCE AND THERMAL CONDUCTIVI		TS EN ISO 11925-2 YANGINA TEPKİ
			TS EN 1603 DIMENSIONAL STABILITY UNDER CONSTANT LABORATORY		ISIL DİRENÇ THERMAL RESISTANCE	ISIL İLETKENLİK THERMAL CONDUCTIVITY	TS EN ISO 11925-2 REACTION TO FIRE
			GENLİKTE IN WIDTH	UZUNLUKTA IN LENGTH			
kar-board 16 kg/m ³	419,66 N	115,20 kPa	-0,1	-0,1	1,427466 m ² K/W	0,036510 W/mk	E
kar-board 20 kg/m ³	370,62 N	103,13 kPa	-0,1	-0,1	1,449443 m ² K/W	0,035696 W/mk	E
kar-board 26 kg/m ³	705,98 N	188,87 kPa	0	0	1,546410 m ² K/W	0,033385 W/mk	E

“hayatı güzelleştiren detaylar”

‘details beautify the life’

KAR-YERİS / YERDEN ISITMA SİSTEMİ

Floor Heating System



ÜRÜN KODU Product Code	ÖLÇÜLERİ Product Dimension	PAKET SAYISI Package Inside	UNIT Package/m ³	UNIT Package/m ²
YERIS 20 DNS/02	05x60x120cm	11 (pcs) adet	0.396 m ³	7.92 m ²
YERIS 26 DNS/03	05x60x120cm	11 (pcs) adet	0.396 m ³	7.92 m ²
YERIS 30 DNS/01	05x60x120cm	11 (pcs) adet	0.396 m ³	7.92 m ²



THERMO-KAR / PALTOLAMA SİSTEMLERİ

Thermo-Kar Jacketing Systems

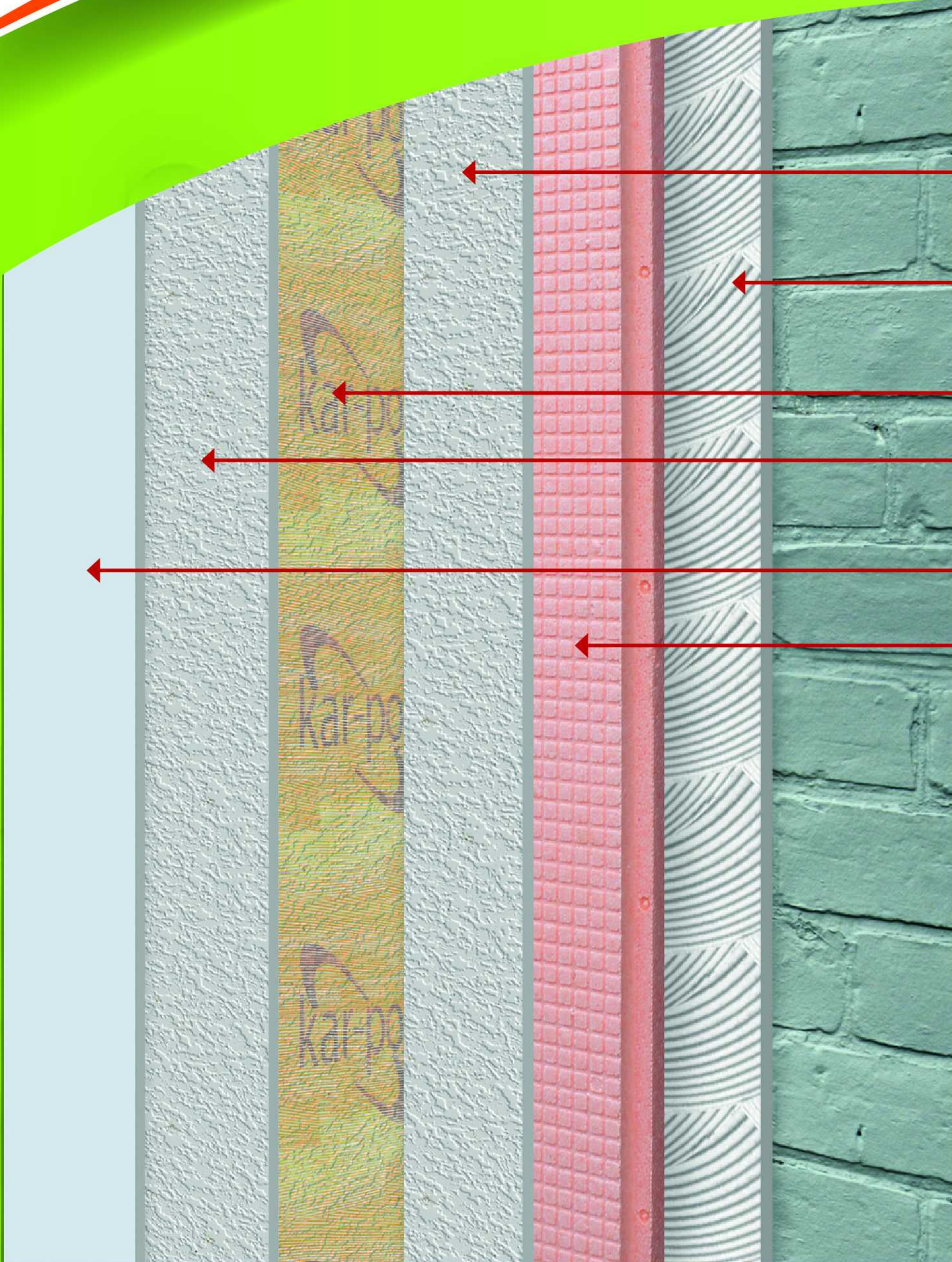

**DONATI SIVASI
KAR-PLAST**
kar-plast plaster

**DONATI YAPIŞTIRICISI
KAR-FİX**
kar-fix adhesive

DONATI FiLESİ
glass-fiber mesh

**DONATI SIVASI
KAR-PLAST**
kar-plast plaster

DIŞ CEPHE BOYASI
exterior paint

KAR-BOARD
kar-board

PALTOLAMA m² PAKET ANALİZİ

Coating m² package analysis

Ürün Product	Kullanılan miktar Quantity	Birim fiyat Unit price	Toplam fiyat Total price
Yalıtım levhası Insulation Panel 2 3 4 5 6 7 8 cm	Kar-Board Kar-Panel Kar-Neopanel 1 m ²		
Yapıştırıcı Adhesive	4 kg.		
PVC dübel PVC peg	6 ad.		
Elyafli sıva Fibre plaster	5 kg.		
Elyaf file (160 gr) Fibre net 160 grs.	1.10 m ²		
Fileli PVC köşe profili PVC edge profil with net	0.25 m		
Sonkat sıva harcı Topcoat plaster mortar	?		
Astar ve boya Lining and paint	?		
Montaj işçiliği Application labor	?		
	Genel sun Genel toplam		

Yapılardaki gereksiz enerji kayıplarının önüne geçilmesi amacıyla, Bayındırlık ve İskân Bakanlığının yayınladığı "Binalarda Enerji Performansı Yönetmeliği" çerçevesinde 1 Ocak 2011 tarihinden itibaren binalar hem enerji tüketimi yönünden hem de sera gazı etkisi (SEG) emisyonu açısından sınırlandırılmaktadır. Artık tüm binalara "Enerji Kimlik Belgesi" zorunluluğu getirilmiştir. Thermo-Kar Isı Yalıtım Sistemleri minimum enerji ile maksimum ısı yalıtımı sağlamaktadır.

The buildings are restricted with energy consumption and SEG emission beginning from 1st January 2011 in the frame of "the Energy Performance Regulations" published by the Ministry of Public Works and Settlement. "Energy Identity Certificate" has become mandatory for all buildings. Thermo-Kar Thermal Insulation Systems provides maximum thermal insulation with minimum energy.

ENERJİ KİMLİK BELGESİ			
Belge No	Tarih		
Bina Tipi	Belgeyi Düzenleyen		
İnşaat Yılı	Oda Sicil No		
Kapalı Kullanım Alanı	Belgenin Son Geçerlilik Tarihi		
Adı, Parsel Adresi	İmza		
MÜB. sahibi:	Müşterek tesisatların sahibi (gerçek kişi)		
İsim:	İsim:		
Adres:	Adres:		
Enerji tipine göre yıllık tüketimler:			
	Nihai Enerji Tüketimleri	Birincil Enerji Tüketimleri	
Enerji Kullanım Alanı	kWhaat	kWhaat	
Isıtma:			
Soğutma:			
Aydınlatma:			
TOTAM:			
Isıtma, soğutma ve aydınlatma için enerji tüketimleri (birincil enerji olarak)		Isıtma, soğutma ve aydınlatma için sera gazı emisyonları (SEG) emisyonları	
Nihai tüketim:		Emisyon salımı:	
.....kWhaat/m ² yıl	kg esd. CO ₂ /m ² yıl	
Tasarruflu Bina	Bina	SEG Emisyonu Düşük Bina	Bina
Enerji Tüketimi Yüksek Bina		SEG Emisyonu Yüksek Bina	

KAR-MOLEN

POLISTREN ASMOLEN Polystyrene Hollow Block

KAR-MOLEN KLAS

POLISTREN ASMOLEN Polystyrene Hollow Block Klas



Rulo ile uygulanabilen aderans arttırıcı astar; file kullanımını gerektirmez ve sıva dökülmesini engeller.

Primer Adhesion Promoter which can be applied by roller does not require to use fibre net and prevents plaster spilling.

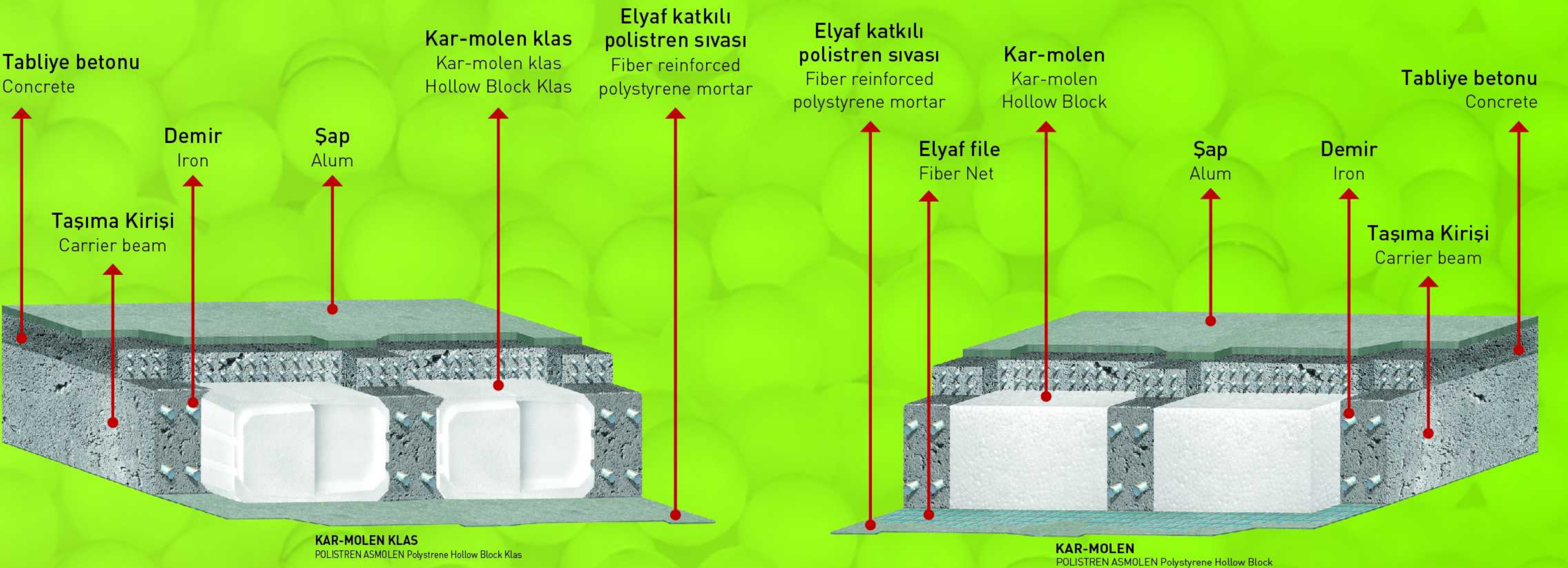
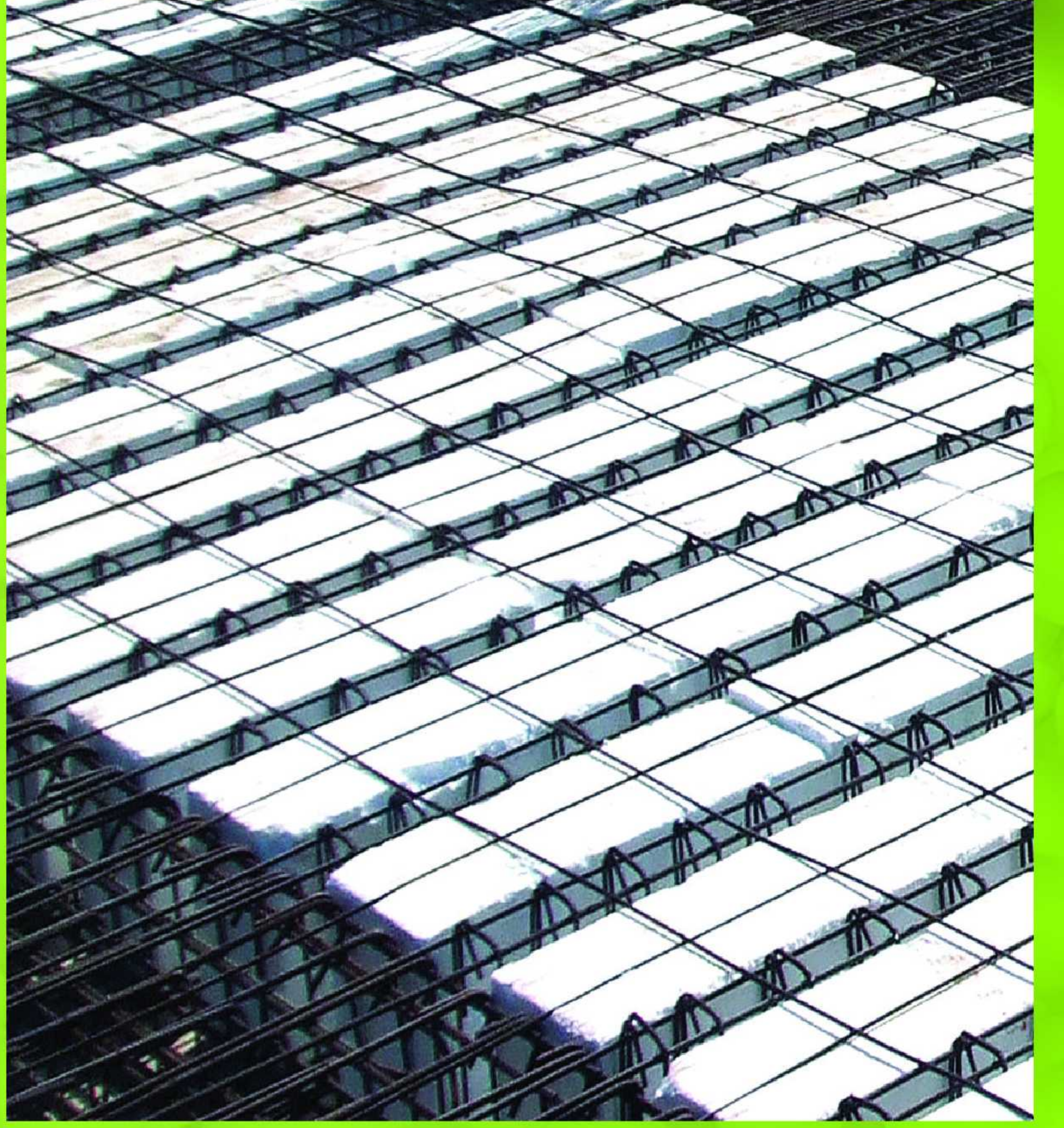

EPS Kar-molen, uygulanan döşemelerde %35 ile %40 oranında dolgu yapmasından dolayı, taşıyıcı kolon ve kirişlerin kesit ölçülerinin küçülmesini, beton ve demir sarfiyatının minimuma düşmesini sağlar. İşçilik ve firede diğer ürünlere göre (Briket, Bims vb) yüksek oranda avantaj sağlar. Kar-molen, izolasyon ürünü EPS'den üretildiği için ısı ve ses yalıtımı da sağlar. Uygulama sırasında kalıp üzerine serilen file, sıva sonrası çatlama riskini de ortadan kaldırır.

Because, it applies 35-40% filling on the coverings, EPS Kar-molen ensures that the sizes of bearing columns and beam sections reduce and the concrete and iron consumption is minimized. Provides high level of advantage in workmanship and wastage (bricks, beams and etc.) compared to other products. Because, the insulation product is manufactured from EPS, Karmolen ensures sound and thermal insulation, as well. Mesh laid on the mould during application removes risk of cracking after plastering.

KAR-BLOK

Polystyrene Block

Ürün Adı Product Name	Ürün Dansitesi Product Density	Ürün Ölçüsü Product Dimension	Birim Ölçüleri Pcs/m ³
BLOK 01	14-16 Dansite	50 cm x 100 cm x 100 cm	0,500
BLOK 10	14-16 Dansite	102 cm x 102 cm x 200 cm	2,080
BLOK 02	20-22 Dansite	51 cm x 102 cm x 200 cm	1,040
BLOK 08	20-22 Dansite	102 cm x 102 cm x 200 cm	2,080
BLOK 05	24-26 Dansite	51 cm x 102 cm x 200 cm	1,040
BLOK 09	24-26 Dansite	102 cm x 102 cm x 200 cm	2,080
BLOK 06	28-30 Dansite	51 cm x 102 cm x 200 cm	1,040
BLOK 07	28-30 Dansite	102 cm x 102 cm x 200 cm	2,080

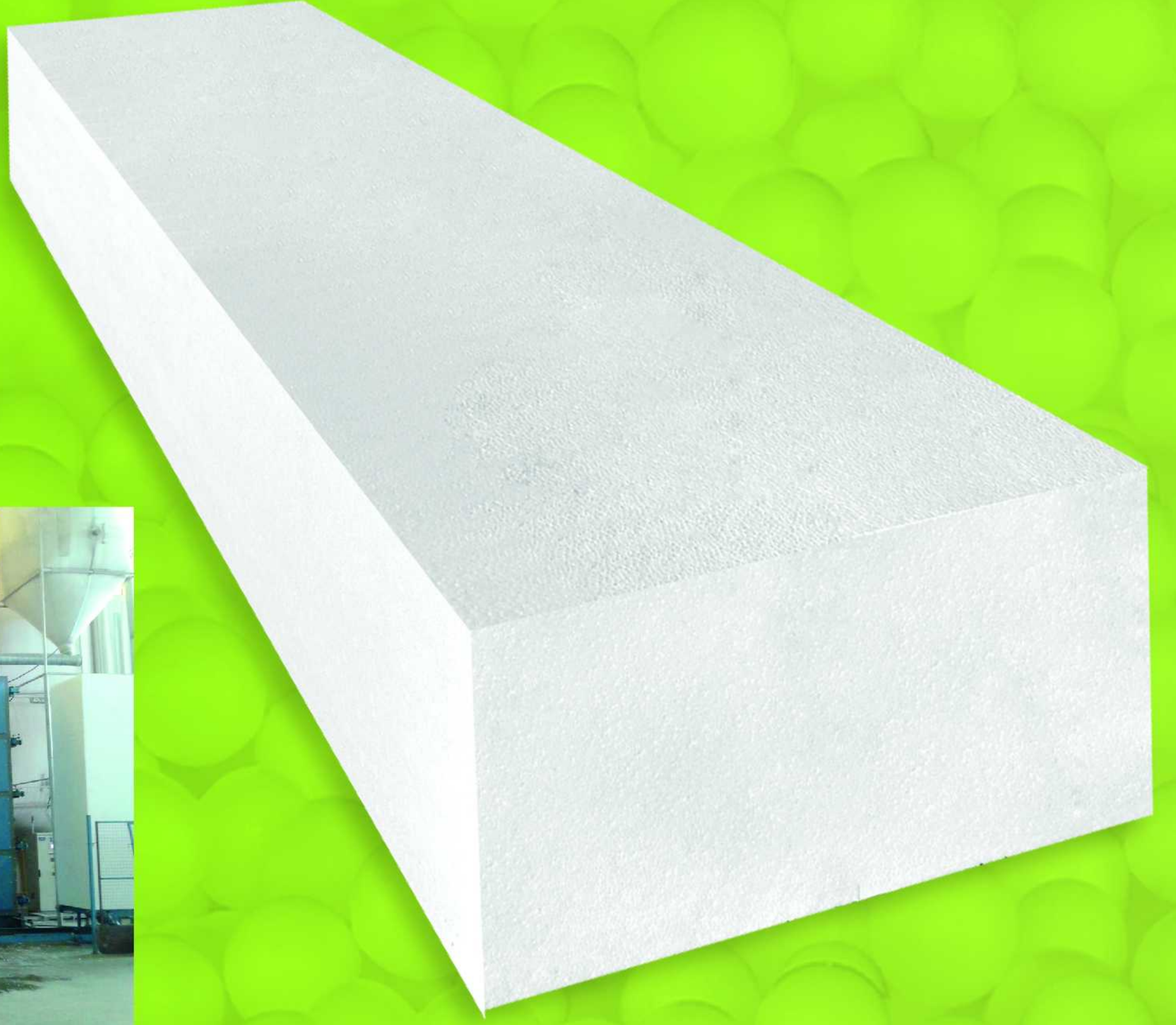

KAR-VİYOL / Kar-Seed Trays

POLİSTREN FİDE VİYOLLER Polystyrene Seed Trays

Tarım sektöründe kullanılan EPS viyoller çok kullanışlı olması, taşıma ve muhafaza kolaylığı sağlamasından dolayı tercih edilmektedir. İstenilen gramajda üretilebilen fide yatağı (viyol) ürünler kalıp sistemi ile üretilmekte, hazır kalıplar yanında talebe göre kalıp imalatı da yapılmaktadır.

EPS viyols (seed trays) are preferred in agricultural sector due to it is practical, easy for transport and storage. Viyol (seed tray) is produced with molds and it can be produced at any basis as requested. Besides exist molds, new molds could be produced if customer demand at different specifications.

Ürün Adı Product Name	En Width	Boy Length	Yükseklik Height
Viyol - 45 Göz Tray - 45 Cells	29,5 cm	50,5 cm	7,3 cm
Viyol - 72 Göz Tray - 72 Cells	33 cm	67 cm	6,5 cm
Viyol - 96 Göz Tray - 96 Cells	46 cm	69,0 cm	7,0 cm
Viyol - 128 Göz Tray - 128 Cells	32,8 cm	66,6 cm	6,5 cm
Viyol - 150 Göz Tray - 150 Cells	47,0 cm	70,0 cm	7,0 cm
Viyol - 180 Göz Tray - 180 Cells	42,0 cm	72,5 cm	6,5 cm
Viyol - 200 Göz Tray - 200 Cells	34,0 cm	69,5 cm	5,0 cm
Viyol - 210 Göz Tray - 210 Cells	32,8 cm	66,5 cm	5,0 cm
Viyol - 216 Göz Tray - 216 Cells	46,8 cm	69,6 cm	7,0 cm
Viyol - 228 Göz Tray - 228 Cells	33,4 cm	52,2 cm	6,5 cm
Viyol - 280 Göz Tray - 280 Cells	33,3 cm	51,5 cm	6,2 cm
Viyol - 300 Göz Tray - 300 Cells	32,8 cm	66,5 cm	5,0 cm
Viyol - 345 Göz Tray - 345 Cells	33 cm	51,7 cm	6,2 cm
Viyol - 350 Göz Tray - 350 Cells	42 cm	72,8 cm	5,5 cm
Viyol - 384 Göz Tray - 384 Cells	46,8 cm	69,8 cm	5,2 cm
Viyol - 425 Göz Tray - 425 Cells	33 cm	51,5 cm	6,5 cm
Viyol - 600 Göz Tray - 600 Cells	46,6 cm	69,50 cm	5,0 cm



KAR-KASA KAR-CRATE

POLISTREN SEBZE MEYVE KASALARI Polystyrene Vegetable-Fruit Crates

crate bottom	KASA TABANI : DELİKLİ / holey
inner size	İÇ EBAT : 56cm x 36cm x 10cm
outer size	DIŞ EBAT : 60cm x 40cm x 12cm
inner volume	İÇ HACİM : 0,0201m³
crate weight	KASA AĞIRLIĞI: 160gr (± %7)



KAR-KASA 101

Taşınacak ağırlıklara göre farklı danstelerde üretim yapılmaktadır.
It is possible to produce in various densities according to weight of goods will be carried.

crate bottom	KASA TABANI : DELİKLİ / holey
inner size	İÇ EBAT : 56cm x 36cm x 12cm
outer size	DIŞ EBAT : 60cm x 40cm x 14cm
inner volume	İÇ HACİM : 0,0241m³
crate weight	KASA AĞIRLIĞI: 180gr (± %7)



KAR-KASA 102

Taşınacak ağırlıklara göre farklı danstelerde üretim yapılmaktadır.
It is possible to produce in various densities according to weight of goods will be carried.

crate bottom	KASA TABANI : DELİKLİ / holey
inner size	İÇ EBAT : 56cm x 36cm x 14cm
outer size	DIŞ EBAT : 60cm x 40cm x 16cm
inner volume	İÇ HACİM : 0,0282m³
crate weight	KASA AĞIRLIĞI: 200gr (± %7)



KAR-KASA 103

Taşınacak ağırlıklara göre farklı danstelerde üretim yapılmaktadır.
It is possible to produce in various densities according to weight of goods will be carried.

crate bottom	KASA TABANI : DELİKLİ / holey
inner size	İÇ EBAT : 56cm x 36cm x 16cm
outer size	DIŞ EBAT : 60cm x 40cm x 18cm
inner volume	İÇ HACİM : 0,0322m³
crate weight	KASA AĞIRLIĞI: 220gr (± %7)



KAR-KASA 104

Taşınacak ağırlıklara göre farklı danstelerde üretim yapılmaktadır.
It is possible to produce in various densities according to weight of goods will be carried.

crate bottom	KASA TABANI : DELİKLİ / holey
inner size	İÇ EBAT : 56cm x 36cm x 18cm
outer size	DIŞ EBAT : 60cm x 40cm x 20cm
inner volume	İÇ HACİM : 0,0362m³
crate weight	KASA AĞIRLIĞI: 240gr (± %7)



KAR-KASA 105

Taşınacak ağırlıklara göre farklı danstelerde üretim yapılmaktadır.
It is possible to produce in various densities according to weight of goods will be carried.





crate bottom
inner size
outer size
inner volume
crate weight

KASA TABANI : DELİKLİ / holey
İÇ EBAT : 7cm x 26,5cm x 26,5cm
DIŞ EBAT : 8,2cm x 28,5cm x 28,5cm
İÇ HACİM : 0,0049m³
KASA AĞIRLIĞI: 45gr (± %7)

KAR-KASA 401

Taşıyacak ağırlıklara göre farklı danstelerde üretim yapılmaktadır.
It is possible to produce in various densities according to weight of goods will be carried.



crate bottom
inner size
outer size
inner volume
crate weight

KASA TABANI: DELİKLİ / holey
İÇ EBAT : 36cm x 26cm x 27cm
DIŞ EBAT : 30cm x 40cm x 30,6cm
İÇ HACİM : 0,0252m³
KASA AĞIRLIĞI: 180gr (± %7)

KAR-KASA 121

Taşıyacak ağırlıklara göre farklı danstelerde üretim yapılmaktadır.
It is possible to produce in various densities according to weight of goods will be carried.



crate bottom
inner size
outer size
inner volume
crate weight

KASA TABANI : DELİKLİ / holey
İÇ EBAT : 36cm x 26cm x 18cm
DIŞ EBAT : 40cm x 30,6cm x 20cm
İÇ HACİM : 0,0168m³
KASA AĞIRLIĞI: 140gr (± %7)

KAR-KASA 122

Taşıyacak ağırlıklara göre farklı danstelerde üretim yapılmaktadır.
It is possible to produce in various densities according to weight of goods will be carried.



crate bottom
inner size
outer size
inner volume
crate weight

KASA TABANI: DELİKLİ / holey
İÇ EBAT : 36cm x 26cm x 14cm
DIŞ EBAT : 40cm x 30,6cm x 16cm
İÇ HACİM : 0,0131m³
KASA AĞIRLIĞI: 120gr (± %7)

KAR-KASA 123

Taşıyacak ağırlıklara göre farklı danstelerde üretim yapılmaktadır.
It is possible to produce in various densities according to weight of goods will be carried.



crate bottom
inner size
outer size
inner volume
crate weight

KASA TABANI: DELİKLİ / holey
İÇ EBAT : 36cm x 26cm x 10cm
DIŞ EBAT : 40cm x 30,6cm x 12cm
İÇ HACİM : 0,009m³
KASA AĞIRLIĞI: 100gr (± %7)

KAR-KASA 124

Taşıyacak ağırlıklara göre farklı danstelerde üretim yapılmaktadır.
It is possible to produce in various densities according to weight of goods will be carried.

TAŞIMA KAPLARI

Carrying Box

İZO KAB 101

İÇ EBAT : 22 x 12 x 13 (cm)
inner size

DIŞ EBAT : 26,6 x 16,6 x 16,6 x 2 (cm)
outer size

KUTU AĞIRLIĞI : 75 gr
box weight

TAŞIMA KAPASİTESİ: 3 kg
carrying capacity



İZO KAB 102

İÇ EBAT : 30,8 x 21,8 x 13 (cm)
inner size

DIŞ EBAT : 34,8 x 25,8 x 16,8 x 2 (cm)
outer size

KUTU AĞIRLIĞI : 140 gr
box weight

TAŞIMA KAPASİTESİ: 5 kg
carrying capacity



İZO KAB 103

İÇ EBAT : 36 x 31 x 18 (cm)
inner size

DIŞ EBAT : 39,6 x 34,6 x 21,6 x 2 (cm)
outer size

KUTU AĞIRLIĞI : 295 gr
box weight

TAŞIMA KAPASİTESİ: 8 kg
carrying capacity



İZO KAB 104

İÇ EBAT : 46 x 36 x 20 (cm)
inner size

DIŞ EBAT : 49,8 x 39,8 x 23,8 x 2 (cm)
outer size

KUTU AĞIRLIĞI : 425 gr
box weight

TAŞIMA KAPASİTESİ: 12 kg
carrying capacity



“hayatı güzelleştiren detaylar”

‘details beautify the life’

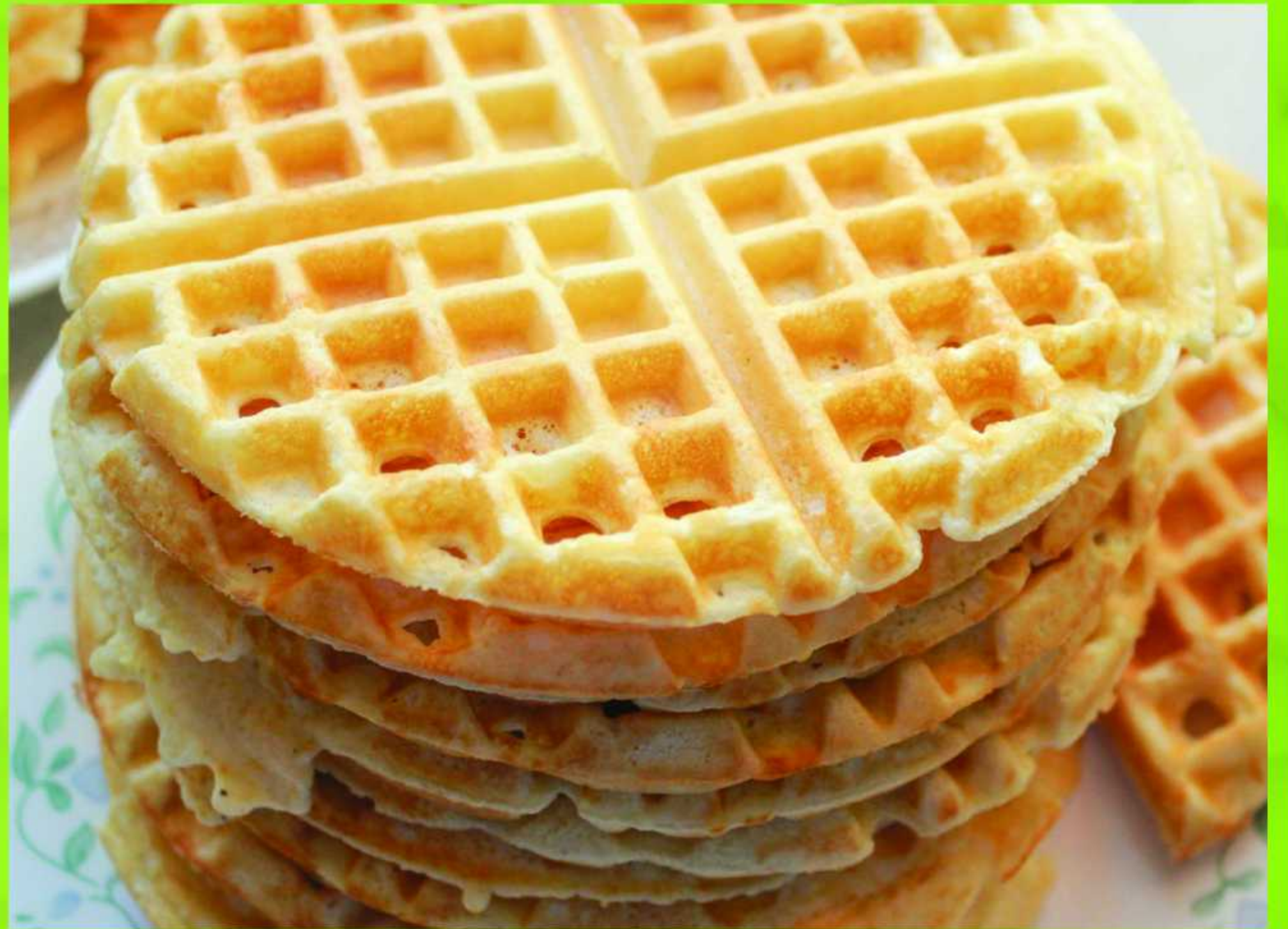

KAR-MER Kar-Marble

POLİSTREN MERMER KUTUSU / Polystyrene Marble Box

KAR - MER 01

box bottom	KUTU TABANI	: DELİKLİ / holey
inner size	İÇ EBAT	: 31cm x 10,5cm x 32cm
outer size	DIŞ EBAT	: 34,5cm x 13,5cm x 35cm
box weight	KUTU AĞIRLIĞI	: 100gr/tk (± %7)
carrying capacity	TAŞIMA KAPASİTESİ:	25kg



KAR - MER 02

box bottom	KUTU TABANI	: DELİKLİ / holey
inner size	İÇ EBAT	: 40,5cm x 7cm x 40cm
outer size	DIŞ EBAT	: 44,3cm x 11cm x 45cm
box weight	KUTU AĞIRLIĞI	: 200gr/tk (± %7)
carrying capacity	TAŞIMA KAPASİTESİ:	25kg



KAR - MER 03

box bottom	KUTU TABANI	: DELİKLİ / holey
inner size	İÇ EBAT	: 46cm x 6,5cm x 46cm
outer size	DIŞ EBAT	: 50,5cm x 11cm x 52cm
box weight	KUTU AĞIRLIĞI	: 300gr/tk (± %7)
carrying capacity	TAŞIMA KAPASİTESİ:	30kg



“hayatı güzelleştiren detaylar”

'details beautify the life'

ÖZEL ÜRÜN ÜRETİMLERİ

Production of Special Products



Makina parkurumuzun çok çeşitli kalıp ölçüsüne sahip olmasından dolayı, EPS üretimimizde çok sayıda standart ürün gruplarının yanı sıra, özel istek ve amaca uygun her sektörün ihtiyacına göre ürünler, düşük maliyetlerle üretilmektedir.

Due to our machine line has various molds sizes, production for special requests and different purposes could be done as well as EPS standard products with low cost.

AMBALAJLI ÜRÜNLER

Packaged products

Regola
hayatı güzelleştiren detaylar...
details beautify the life...





Regola markası adı altında, iç dekorasyon ürünlerini nihai tüketiciye direkt ulaştırarak “KENDİN YAP!” prensibini ön plana çıkarmaktadır. Satış ağı gerek yapı marketler, gerekse internet üzerinden on-line satış şeklindedir. Orijinal ambalajındaki her ürünün montajı, yedi farklı dil seçeneği ile sunularak tüketicilere büyük kolaylık sağlanmaktadır. Ürünler çağdaş, ekonomik, esnek, hafif ve kolay montaj edilmesiyle de avantaj sağlar.



Under Regola brand, it brings principle of “DO IT YOURSELF!” into the forefront by delivering interior decoration products to final consumer directly. Sales network is construction markets and online sales. Montage instruction of any product in original package is offered with seven different languages to make it easy for consumers. The products provides great advantages with their modern, economic, flexible, light and easy to install properties.

EPS KLAS MODELLER

eps klas models

REGOLA EPS KLAS 151



REGOLA EPS KLAS 201



REGOLA EPS KLAS 202



REGOLA EPS KLAS 204



REGOLA EPS KLAS 251



REGOLA EPS KLAS 271



PERDELİK TAKVİYELERİ

curtain supports

perdelik montaj kesiti
curtain support cross-section

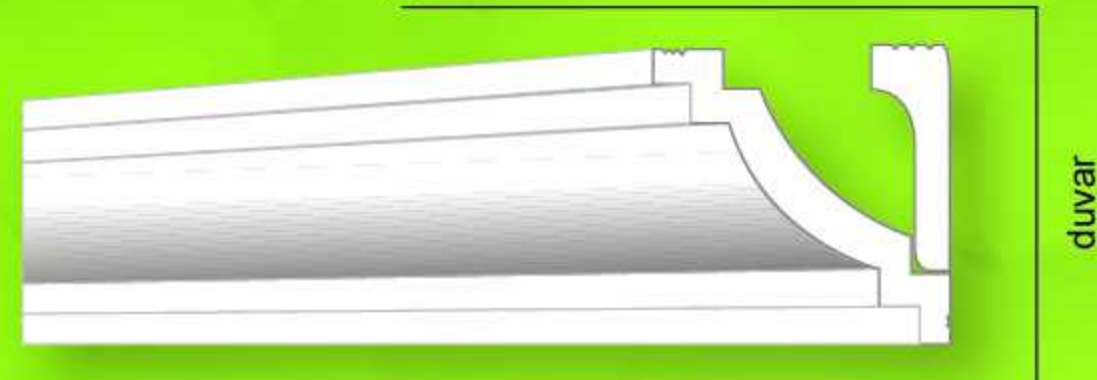

for 10 cm Curtain Support **Regola Per-10**



KARTONPİYER MODELLERİ

Moulding Models

REGOLA EKO 006



REGOLA EKO 013



REGOLA EKO 021



REGOLA EKO 016



REGOLA EKO 033



REGOLA EKO 024



REGOLA EKO 026



REGOLA STD 038



REGOLA STD 046



REGOLA STD 029



REGOLA STD 040



AMBALAJLI ÜRÜNLER

Packaged Products

LAMBA GÖBEKLERİ

lamp centers



REGOLA KG 70
51 cm x 48 cm



REGOLA KG 71
54 cm



REGOLA KG 72
53 cm x 46 cm



REGOLA KG 73
40 cm x 37 cm



REGOLA KG 74
42 cm



REGOLA KG 75
35 cm x 40 cm



REGOLA KG 76
52 cm



REGOLA KG 77
39 cm



REGOLA KD 105
42 cm



REGOLA KD 106
48 cm



REGOLA KD 108
38 cm



REGOLA KD 109
48 cm



REGOLA KD 110
38 cm



REGOLA K. Çerçeve Ç-002
52 cm x 52 cm



REGOLA ÇKD 02
21 cm x 21 cm



REGOLA ÇM 01
13 cm x 25 cm



REGOLA ÇKD 01
21 cm x 21 cm

DEKORATİF TAVAN KAPLAMALARI

decorative ceiling plates



EKONOMİK Economic

REGOLA 5001 / 49,5 cm x 49,5 cm

REGOLA 5002 / 49,5 cm x 49,5 cm

REGOLA 5003 / 49,5 cm x 49,5 cm

REGOLA 5005 / 49,5 cm x 49,5 cm

REGOLA 5006 / 49,5 cm x 49,5 cm

REGOLA 5009 / 49,5 cm x 49,5 cm

REGOLA 5010 / 49,5 cm x 49,5 cm

REGOLA 5011 / 49,5 cm x 49,5 cm

REGOLA 5015 / 49,5 cm x 49,5 cm

STANDART Standard

REGOLA 1111 / 50,2 cm x 50,2 cm

REGOLA 1112 / 50,2 cm x 50,2 cm

REGOLA 1113 / 50,2 cm x 50,2 cm

REGOLA 1114 / 50,2 cm x 50,2 cm

REGOLA 1117 / 50,2 cm x 50,2 cm

AHŞAP MODELLER

Wooden Models

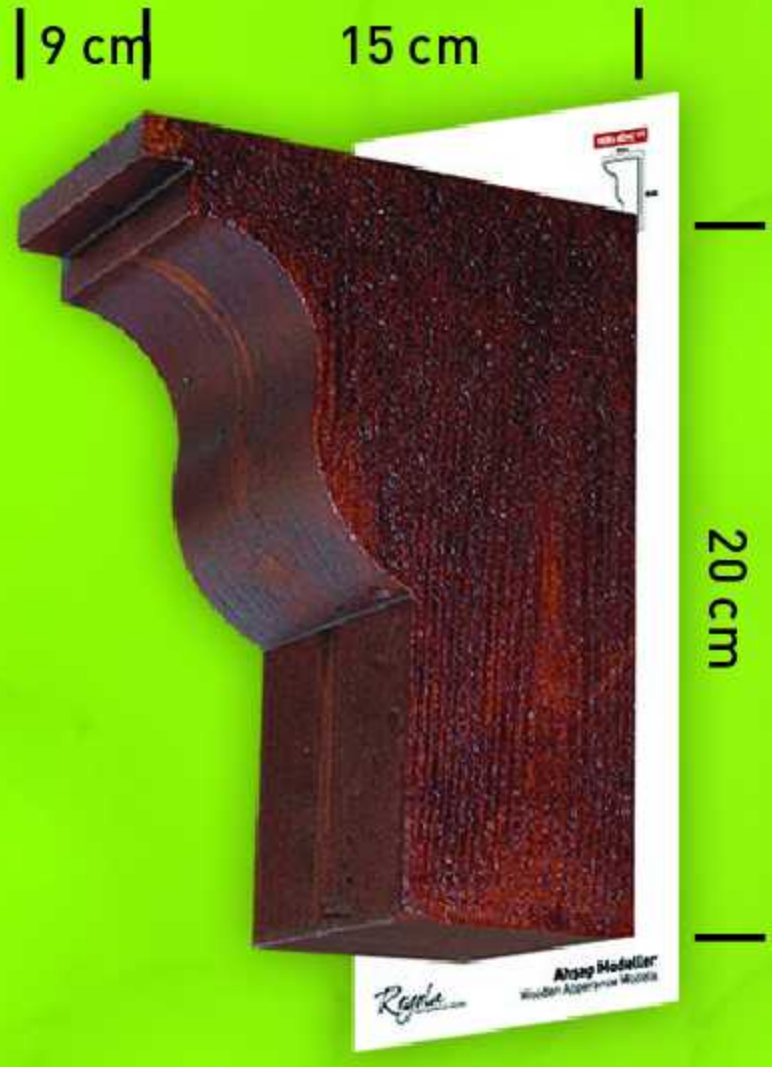

REGOLA AĞAÇ 17

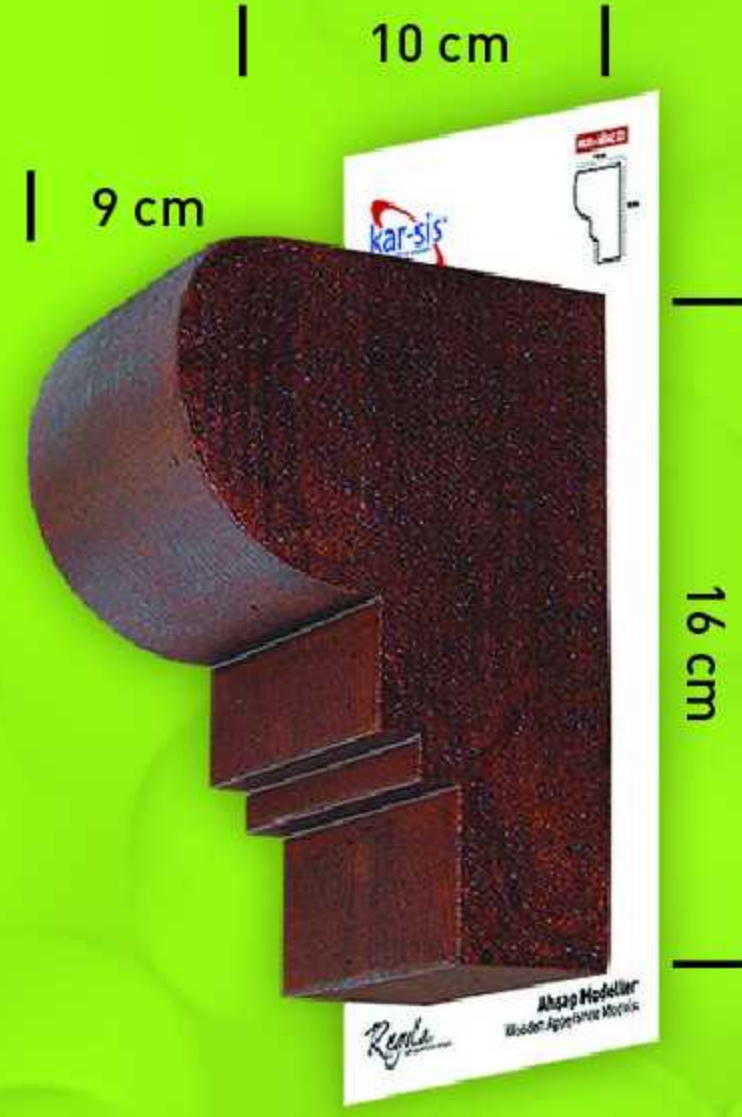

REGOLA AĞAÇ 22



REGOLA AĞAÇ 24

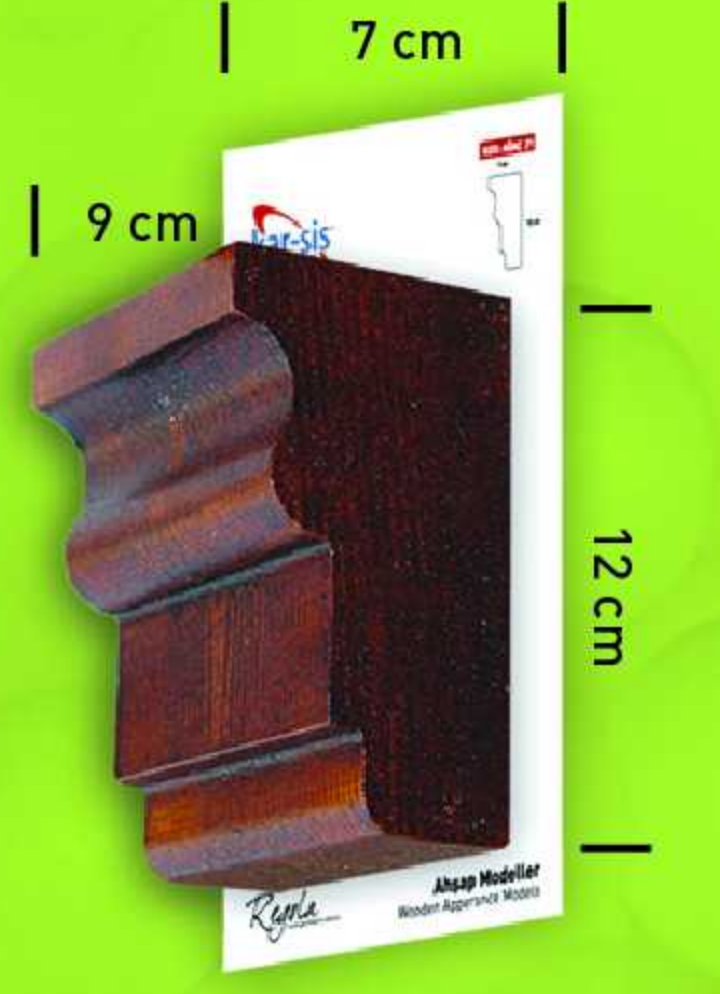

REGOLA AĞAÇ 21



REGOLA AĞAÇ 30



REGOLA AĞAÇ 15



REGOLA AĞAÇ 26

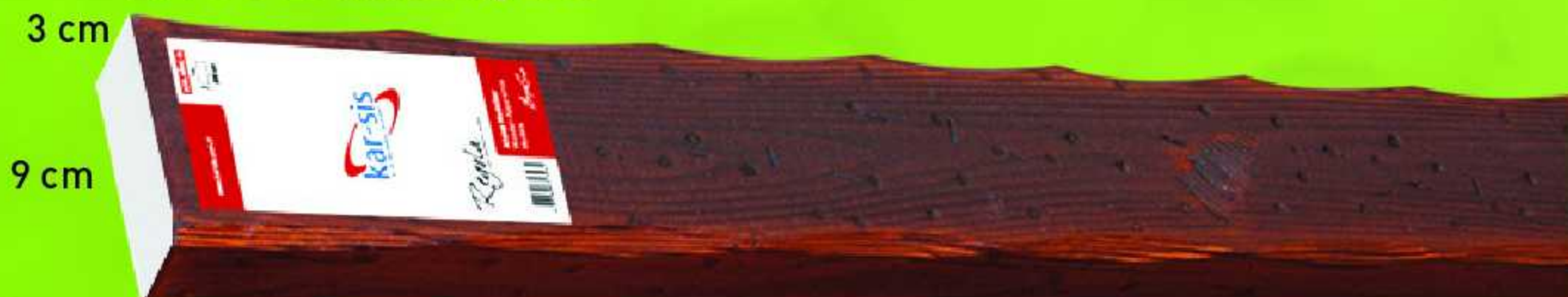

REGOLA AĞAÇ 25

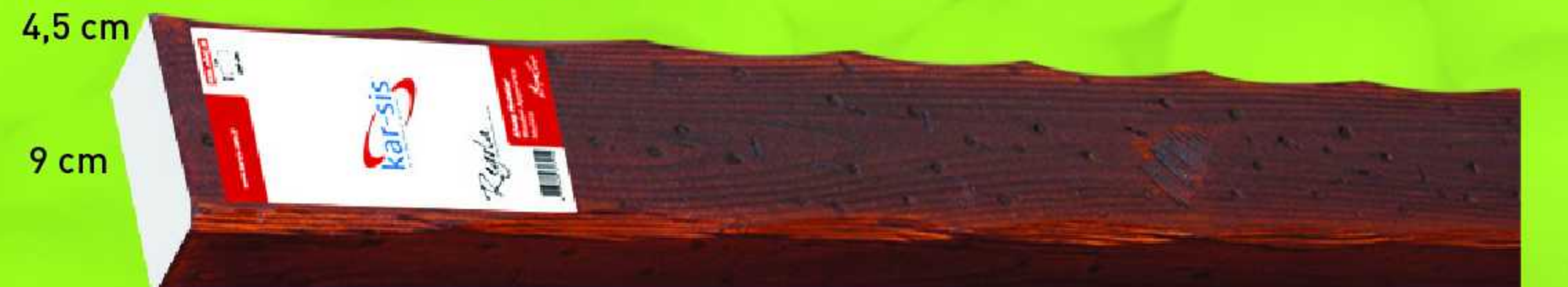

MARKET İÇİ RAF DÜZENEĞİ

Market Booth Equipment

Küçük Ölçekli Market Standı

Small Size Market Booth



Gondol Başı Market Standı

Gondola Head Market Booth



Stantlarımız, marketlerin talebine uygun olarak; büyük, orta, küçük boy ve gondol başı olarak dizayn edilmiştir. Stantların ebat ve içeriği, ürünlerimizin satış oranları, birbirlerini tamamlamaları ve fiyat yapısı dikkate alınarak hazırlanmıştır. Ölçülerde değişiklik yapılması uygun değildir.

Our booths are designed complying with customer demands as Big, Middle, Small and Gondole Head sized. Content and dimensions of the stands are prepared in reference to sales percentages, prices and complementary property of products. No changes are possible in stand dimensions.

Orta Ölçekli Market Standı

Midium Size Market Booth



Büyük Ölçekli Market Standı

Big Size Market Booth

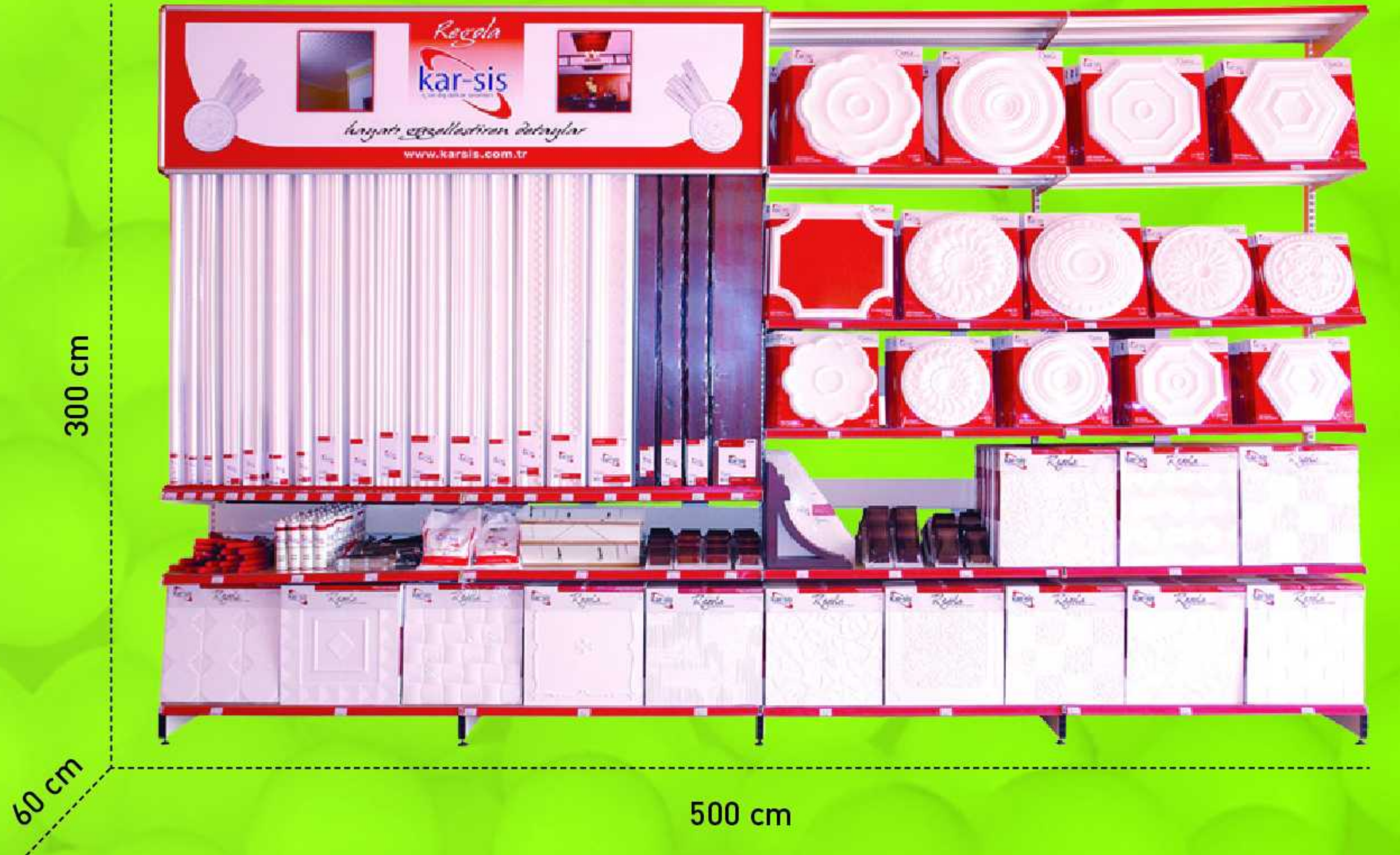

HKS Fix 2 kg
HKS Fix 2 kg



HKS
Özel Mastik
500gr

HKS
Special Mastic
500gr



Kesim Aparatı
Cutting Apparatus

YAPI KİMYASALLARI
Constrution chemicals



“hayatı güzelleştiren detaylar”

‘details beautify the life’



HKS Özel mastik 500gr
HKS Special Mastik 500gr

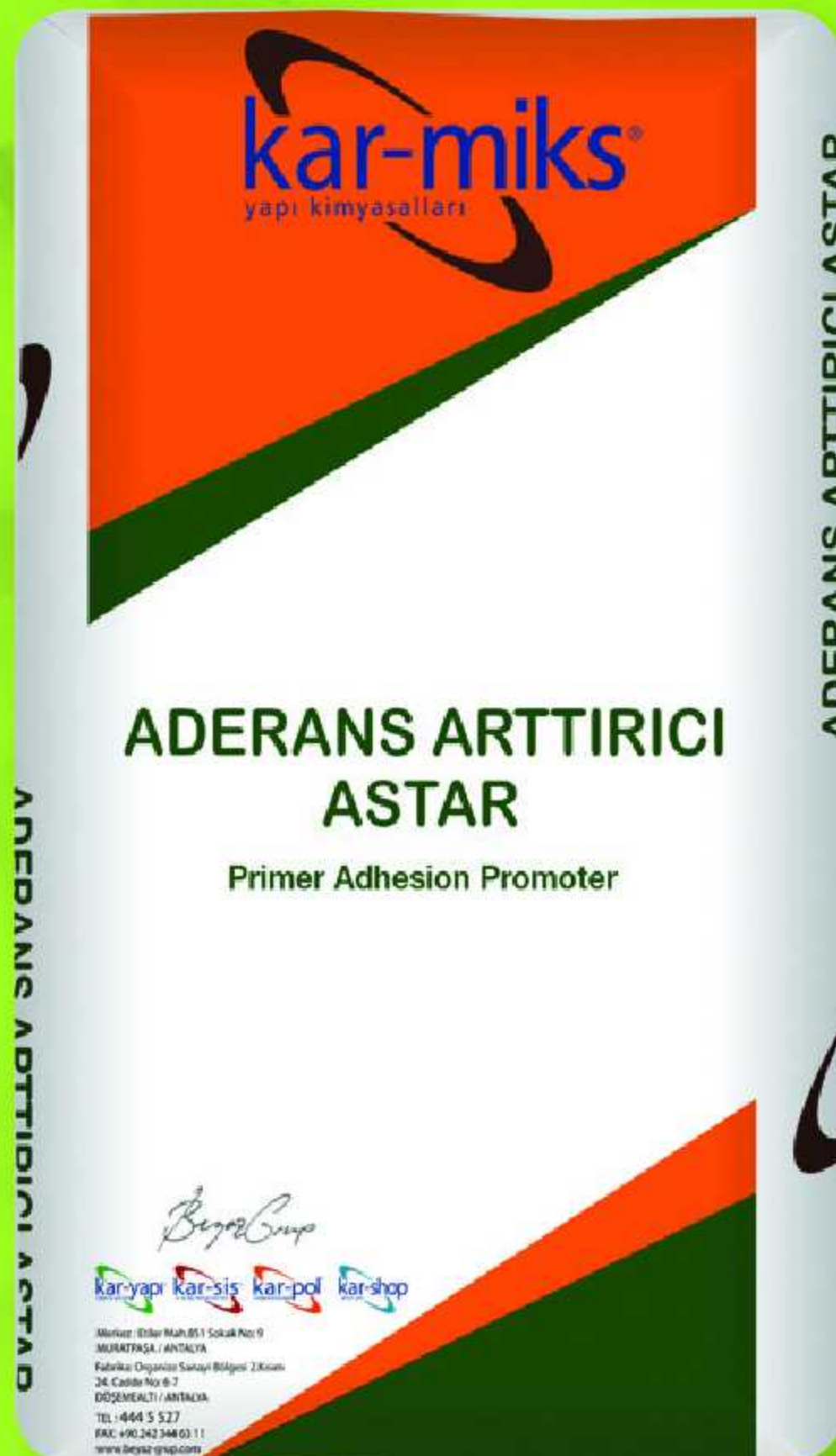

HKS Fix 2 kg
HKS Fix 2 kg

HKS Fix 5 kg
HKS Fix 5 kg

HKS Fix 10 kg
HKS Fix 10 kg

MÜŞTERİ MEMNUNİYETİ

Mevcut müşteri ilişkilerinin daha kuvvetli ve kalıcı olması için müşteriye verilen sözlerin, mevcut bütün imkânlar kullanılarak yerine getirilmesi ve müşteri memnuniyetinin sağlanması.

CUSTOMER SATISFACTION

Fulfilling any promises to the customers by using all means necessary for stronger and more sustainable customer relations and ensuring customer satisfaction.

YENİ ÜRÜNLER GELİŞTİRMEK

Rekabetin yönünü değiştirecek, sektörü yönlendirecek. Bu yöndeki fikir ve çalışmaları desteklemek, yenilikçi olmak. Pazara yeni ürünleri kazandırmak.

DEVELOPING NEW PRODUCTS

Supporting ideas and studies to change way of competition and direct the sector, being an innovative. Providing new products for the market.

TESLİM VE TEMİN SÜRECİNİN İŞLEYİŞİ

Müşteriden siparişin alınmasından, teslim edilmesine kadar olan süreçte, müşteri beklentilerini karşılayacak şekilde en iyi hizmetin gerçekleştirilmesi, bu süreçte mal ve bilgi akışının sürekli ve kaliteli yapılması.

DELIVERY AND SUPPLY PROCESS

Providing the best services to meet the customer expectations during the process from taking the order to delivering it and providing good and information flow of that process is continuous and high-quality.

Dünyanın neresinde olursanız olun,
sizler için üretiyoruz...

Wherever you are in the world, we produce for you ..



POLİTİKAMIZ

Policy

İNOVASYON

Kalite yönetim sistem anlayışını benimseyen kurumumuzda mevcut sistemin etkinliğinin ölçülmesi, iyileştirilmesi ve geliştirilerek örnek teşkil edecek durum haline getirilmesi.

INNOVATION

Measuring the efficiency of the current system, improving and developing it in our firm adopting the quality management system approach to set an example.

KALİTE

Kalite yönetim sistem anlayışını benimseyen kurumumuzda personelimizin “kendi geleceğini firmanın geleceğinden görme” anlayışı çerçevesinde katılımlarının sağlanarak, iş ve sosyal yaşantılarında kalite yaşam anlayışının temellerini hazırlamak. Tüm birim ve tarafların katılımı ile organizasyonumuz için ortak karar alma, birlikte gelişim sürdürülebilir büyüme vizyonu sağlamak.

QUALITY

Ensuring the participation of personnel and preparing the foundations of the quality life approach at work and social life in the frame of "seeing future through the eyes of the firm" in our firm adopting the quality management system approach. Taking common decisions for our organization and providing a sustainable development vision by participation of all departments and parties.

MARKA

Firma marka bilinirliğinin mevcut durumunu korumak, mevcut durumdan daha ileriye götürmek, sektör içinde ilk akla gelen marka olmak, bunu sürdürülebilmek, sektör dışında markasından söz ettirmek, bunu geliştirmek, ulusal bir marka olma yolunda çalışmalarını destekleyerek, bu hedefe ulaşmak.

BRAND

Maintaining current awareness of the brands of firm, improving that awareness, becoming the first remembered brand of the sector and maintaining that status, mentioned in other sectors and developing that status and achieving being a national brand by supporting that goal.



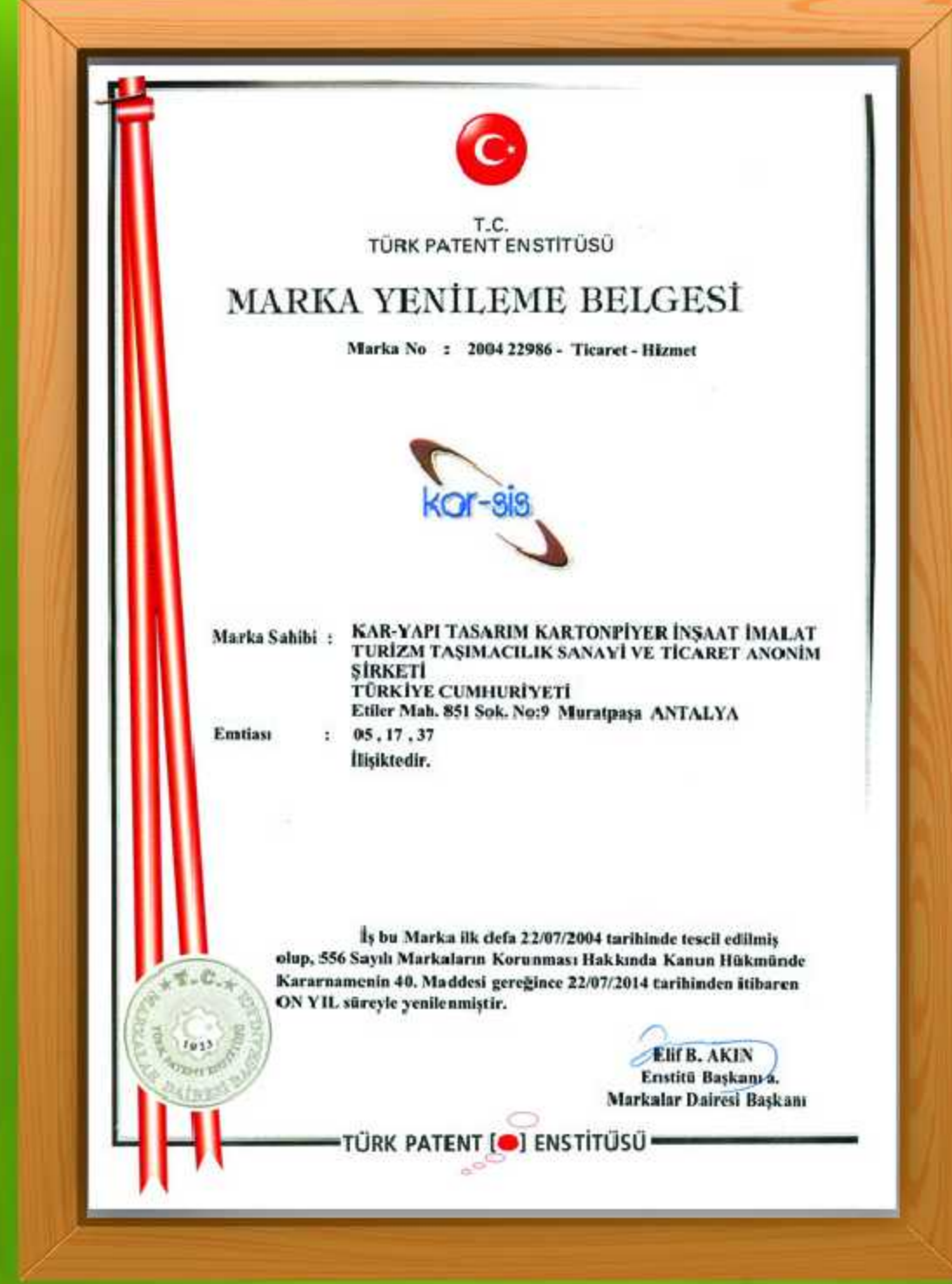

BELGELERİMİZ

Certificates

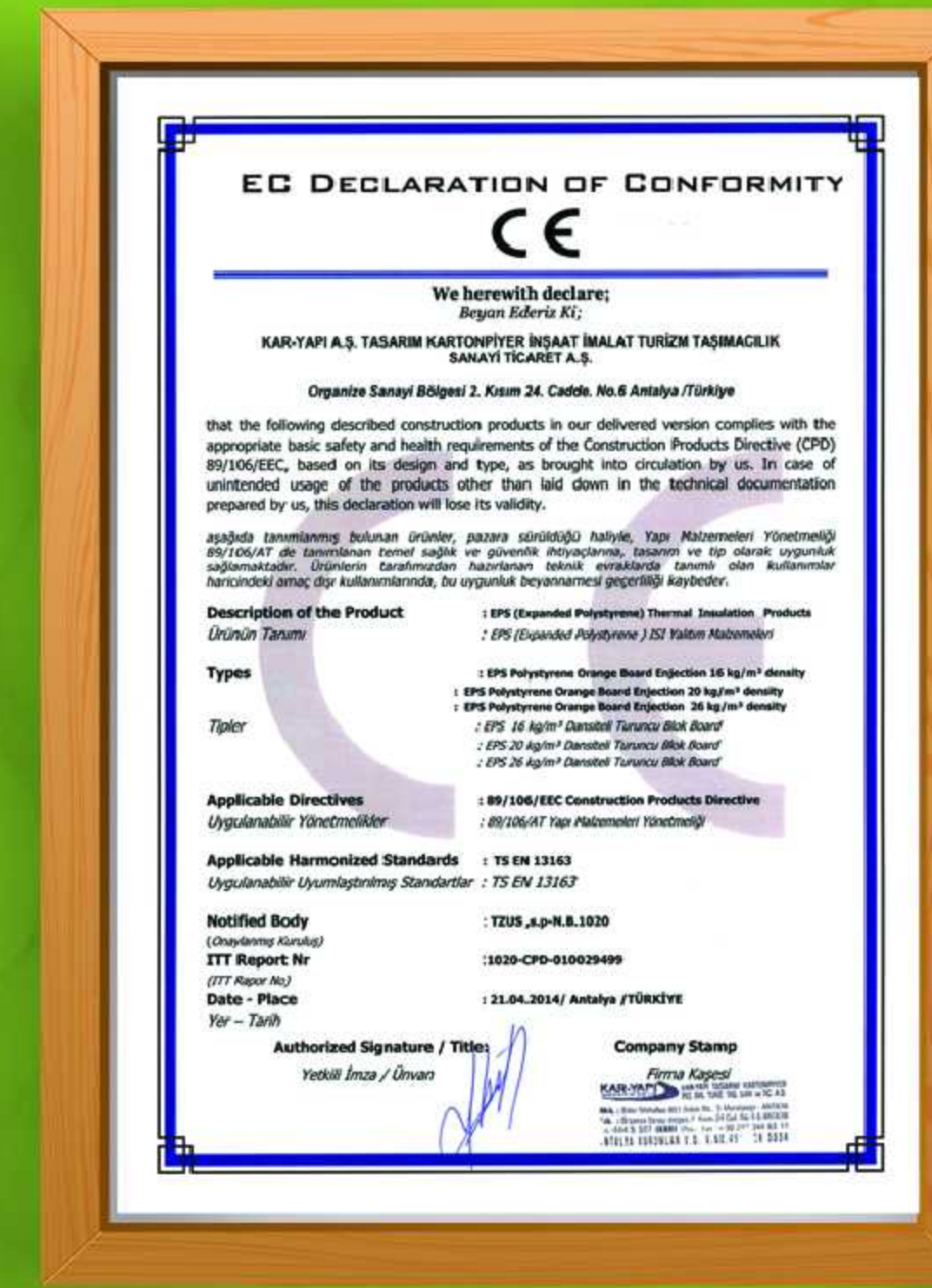



BÖLGE TEMSİLCİLİKLERİMİZ

Regional Agencies

MERKEZ BÖLGE

1. BÖLGE(DOĞU)	ANTALYA (Muratpaşa-Aksu-Serik-Manavgat-İbradi-Akseki-Gündoğmuş-Alanya-Gazipaşa)	+90 533 277 62 29
1. BÖLGE(BATI)	ANTALYA (Döşemealtı-Kepez-Konyaaltı-Kemer-Kumluca-Kaş-Demre-Finike-Elmalı-Korkuteli)	+90 533 277 73 28
2. BÖLGE	BURDUR-İSPARTA-AFYON-KONYA-KARAMAN	+90 532 672 48 35
3. BÖLGE	MERSİN-ADANA-OSMANIYE-HATAY	+90 530 762 40 50
4. BÖLGE	KAYSERİ-NİĞDE-NEVŞEHİR-AKSARAY-KIRŞEHİR-YOZGAT-SİVAS	+90 533 277 73 25

DOĞU BÖLGE

5. BÖLGE	KİLİS-G. ANTEP-ADİYAMAN-K. MARAŞ-ELAZIĞ-MALATYA-TUNCELİ	+90 532 676 29 34
6. BÖLGE(BATI)	DİYARBAKIR-ŞANLIURFA-MARDİN-BATMAN-SİİRT-ŞIRNAK	+90 534 490 69 41
6. BÖLGE(DOĞU)	VAN-AĞRI-IĞDIR-BİTLİS-BİNGÖL-MUŞ-HAKKARİ	+90 532 673 78 17
7. BÖLGE	TRABZON-GİRESUN-GÜMÜŞHANE-BAYBURT-RİZE-ERZİNCAN-ERZURUM-ARTVİN-ARDAHAN-KARS	+90 533 325 29 69
8. BÖLGE	KASTAMONU-SİNOP-SAMSUN-AMASYA-TOKAT-ORDU	+90 533 277 73 26

BATI BÖLGE

9. BÖLGE	ANKARA-ÇORUM-ÇANKIRI-KIRIKKALE	+90 532 675 72 08
10. BÖLGE	İSTANBUL ANADOLU-KOCAELİ-SAKARYA-DÜZCE-BOLU-ZONGULDAK-BARTIN-KARABÜK	+90 533 277 73 24
11. BÖLGE	İSTANBUL AVRUPA-KIRKLARELİ-TEKİRDAĞ-EDİRNE	+90 532 728 10 68
12. BÖLGE	ÇANAKKALE-BALIKESİR-BURSA-YALOVA-KÜTAHYA-BİLECİK-ESKİŞEHİR	+90 532 671 02 47
13. BÖLGE	İZMİR-MANİSA-AYDIN-UŞAK-DENİZLİ-MUĞLA	+90 530 762 40 51

DIŞ TİCARET / EXPORT

+90 539 589 49 01 +90 533 277 73 29

KAR-YAPI
TASARIM KAR. İNŞ. İML. TURZ. TAŞ. SAN. TİC. A.Ş.

www.kar-yapi.com.tr info@kar-yapi.com.tr

Organize Sanayi Bölgesi 2. Kısım 24. Cadde No:6
Döşemealtı ANTALYA / TURKEY Fax : +90 242 258 17 59

444 5 KAR
+90532 111 5 KAR

EPSDER
EPB SANAYİ DERNEĞİ

İZODER
İSİS 85 44 YATIRIMCILAR DERNEĞİ

GA
TÜRKİYE
GİZLİLİK

CE

TSE

RECYCLE

